

NEW PRODUCTS 2018 — 2019

EFFICIENT SOLUTIONS

2018 — 2019





AQUAREA

P. 10



DOMESTIC

P. 48



COMMERCIAL

P. 66



VRF SYSTEMS

P. 138



REFRIGERATION

P. 176



PANASONIC: ECO & SMART IDEAS FOR A SUSTAINABLE LIFESTYLE

A better life, a better world.
Panasonic is creating a safe and secure society with clean energy.



Solar Power Generator

HIT solar cells achieve maximum output even on smaller roofs.

Home AV

Panasonic offers a wide range of energy saving home equipment to fulfil a sustainable and comfortable lifestyle.

Heat Pump

The Aquarea Heat Pump is part of a new generation of heating systems that use a renewable, free energy source: air, to heat or cool the home and to produce hot water.

Fuel Cell

The Panasonic Fuel Cell is an energy-creating device, which generates electricity and heat at the same time with chemical reaction between hydrogen extracted from natural gas and oxygen.

Solar Power Generator

Our mobility space can be connected to our HIT solar panels – with the help from our storage batteries.

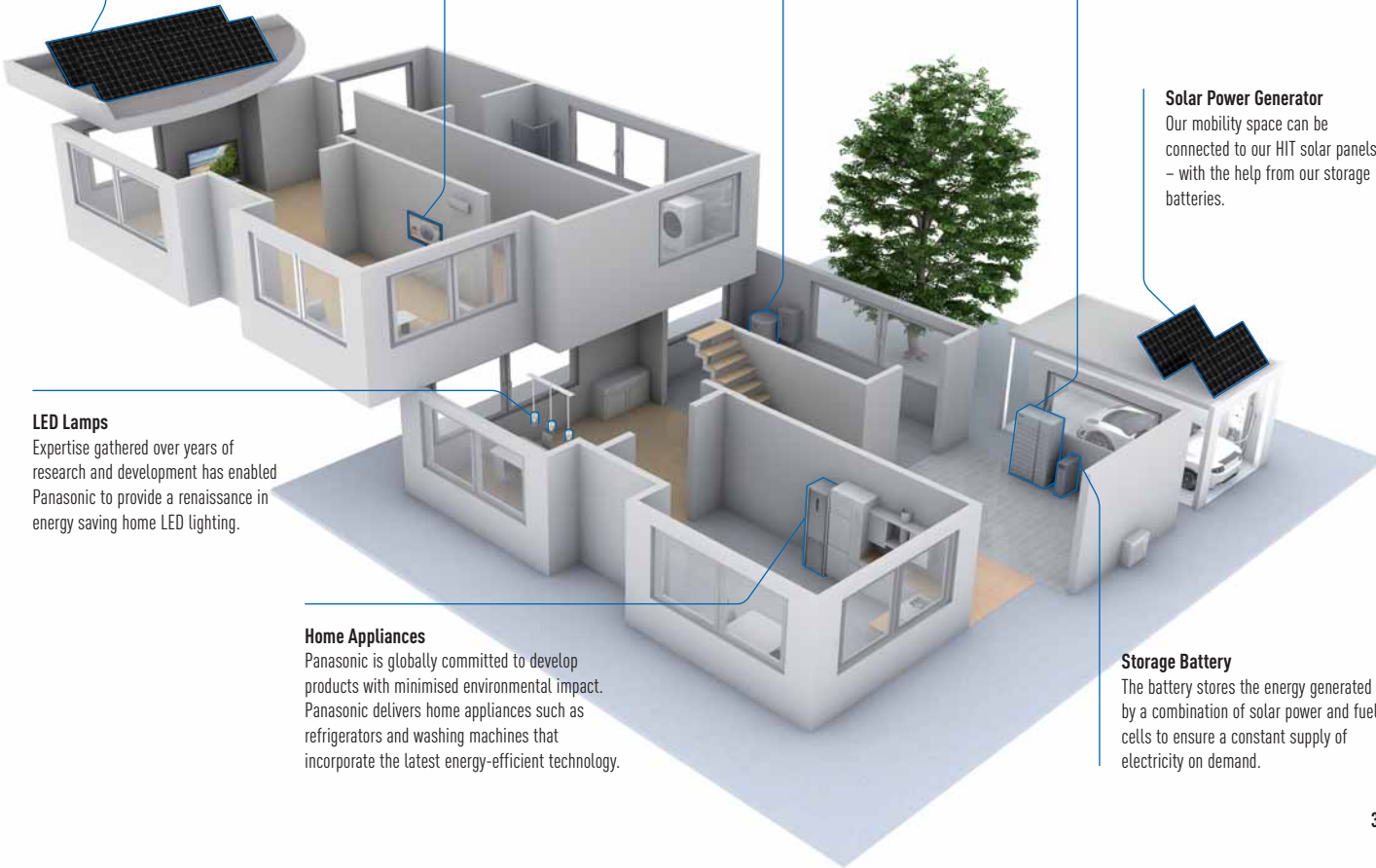

LED Lamps

Expertise gathered over years of research and development has enabled Panasonic to provide a renaissance in energy saving home LED lighting.

Home Appliances

Panasonic is globally committed to develop products with minimised environmental impact. Panasonic delivers home appliances such as refrigerators and washing machines that incorporate the latest energy-efficient technology.

Storage Battery

The battery stores the energy generated by a combination of solar power and fuel cells to ensure a constant supply of electricity on demand.

A DESIRE TO CREATE THINGS OF VALUE



"Recognising our responsibilities as industrialists, we will devote ourselves to the progress and development of society and the well-being of people through our business activities, thereby enhancing the quality of life throughout the world."

Panasonic Corporation's Basic Management Objective, formulated in 1929 by the company's founder, Konosuke Matsushita.

Panasonic: celebrating two major milestones in 2018.



Panasonic Corporation, 100th anniversary

Look ahead to the "Future," keep taking on challenges. Starting back in 1918, Panasonic has constantly added to its guarantee for innovation, taking tomorrow's technologies and applying them to today's needs.

Always making "people" central to our activities, and thereby focusing on "people's lives," we will continue to provide better living for our customers. This is the unchanging commitment we at Panasonic have had over many years.

Now, we are aiming to expand our contribution to "better living" everywhere. This means that in the variety of spaces where our customers go about their lives, ranging from inside the home, the office, the store, the automobile, and the airplane, as well as in the town, we will provide not only single pieces of hardware, but also total solutions including software and services. We will pursue the concept of "A Better Life, A Better World," meeting the needs of each individual customer.

To that end, we will leverage the strengths that we at Panasonic have long developed in our consumer electronics business, together with the strengths of our business partners who have in-depth expertise in many areas, and we will work to combine these strengths by pursuing "Cross-Value Innovation." In this way, we will create new value. This is the new and challenging task we are now addressing.



1958
First room air conditioner launched for domestic installation.

Panasonic Heating and Cooling, 60th anniversary

Panasonic starts with a desire to create things of value. Sixty years ago, as hard work and dedication results in one innovative product after another, the new company took its first steps towards becoming the electronics giant of today. Heating and Cooling Solutions designed and produced by Panasonic since 1958.



1971
Starts production of absorption chillers.



1973
Panasonic launches the first highly efficient air-to-water heat pump in Japan.



1975
Panasonic becomes the first Japanese air conditioner manufacturer in Europe.



1985
Introduces first GHP (gas heat pump) VRF air conditioner.



1989
Introduces world's first simultaneous 3-Pipe heating/cooling VRF System.



2008
Etherea new concept: high efficiency and high performances with a great design.



2010
New Aquarea. Panasonic introduces Aquarea, an innovative new, low-energy system in Europe.



2012
New GHP units. Panasonic's gas-driven VRF Systems are ideal for projects where power restrictions apply.



2016
New VRF Systems ECOi EX with extraordinary energy-saving performance.



Looking ahead
The first Hybrid System with VRF and GHP in Europe.

PANASONIC HEAT PUMPS TOP 3 BEST IN TEST

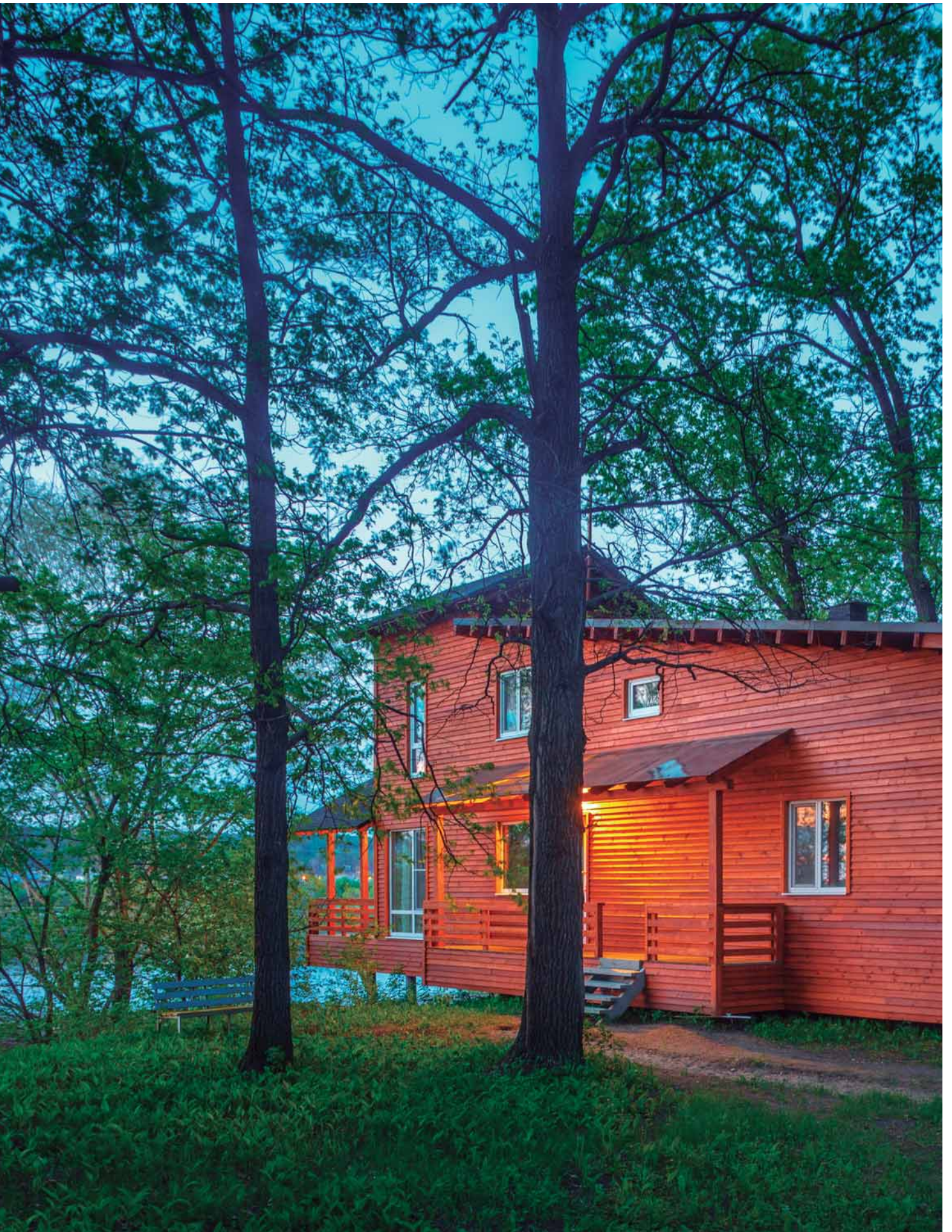

To all that we then add sophisticated and elegant designs. Our heat pumps are like that: innovative inside and beautiful outside.

Panasonic's heat pumps are the heat source of choice for the future

Leadership isn't something you can just get. You have to show it. Which is why at Panasonic we strive each and every day to make our heat pumps highly reliable and surprisingly efficient, with minimum noise impact and the lowest environmental footprint possible.



Heatcharge. The energy efficient air to air heating for Nordics

The best proof of our commitment is that we are moving ahead of the sector by including the R32 refrigerant in our entire range of domestic air conditioners, representing an enormous technological lead that manages to combine excellent comfort in the home and perfect harmony with the environment.



VZ Heatcharge9SKE

The model has the highest energy class A+++ and offers maximum comfort and energy savings. This powerful air heat pump is designed for commercial and residential environment with extremely high demands on the heating system. Heatcharge has a revolutionary storage technology that captures and stores heat from the compressor. The result is our most reliable and powerful heat pump ever.

Aquarea. The new generation of energy efficient heating and hot water

Aquarea All in One belongs to the new generation of Panasonic heat pumps for heating, cooling and providing hot water in the home. Aquarea T-CAP is one of the newest heat pumps on the market, and maintains nominal heating capacities even at temperatures as low as -20 °C. This ensures the best possible seasonal energy efficiency ratio. The heat pumps are tested at an outdoor temperature of -27 °C, to ensure the most efficient and stable operation in the Nordic climate.



Aquarea All in One H Generation

Compact and Easy to install. All in One is a space-saving solution, ideal to install in the laundry room. In addition, Panasonic has developed a range of controls that allow control of two heating zones, bivalent and cascade systems.

PRO CLUB. THE PROFESSIONAL WEBSITE OF PANASONIC



PRO Club 

Download on
www.panasonicproclub.com
 or connect simply with your
 smartphone to the PRO Club
 using this QR



Panasonic has an impressive range of support services for designers, specifiers, engineers and distributors working in the heating and cooling markets. Panasonic PRO Club is the online tool which makes your life easier! You just have to register and a lot of functionalities are freely available to you, where ever you are, from your computer or smartphone!

VRF Designer

Building on the success of the ECOi VRF Designer software, this package provides air conditioning system designers, installers and dealers with a program to design and size projects for Panasonic's VRF ranges.



Aquarea Designer

Panasonic provides bespoke software helping system designers, installers and dealers to very quickly design and size systems, create wiring diagrams and issue bills of quantities at the push of a button.



Panasonic helps you to calculate the system label

From 26th September 2015, installers can be assured that all products manufactured after this date will be sold with the required ErP labels which will aid installers with their paperwork. While it is the manufacturer's responsibility to issue their products with the required labels, the installers will need to calculate and issue an efficiency label for the entire heating system. Whether installing a new heating system or installing new boilers, controls or renewables into an existing system, it is, and will continue to be, the installer's responsibility to calculate and issue efficiency labels. Calculators which assist installers with this process are available on the Panasonic Heating & Cooling Solutions website.

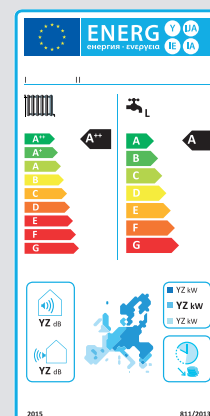

Panasonic, a partner with the knowledge and experience to achieve your objectives and green needs.

Integrated technology that permits better work, easy installation, high efficiency performance, and energy savings

Our main targets are the distributed services and B2B-integrated solutions.

Panasonic provides a single point of contact for the design and maintenance of your system, making things easy for you.

Given our experience in processes, technologies and complex business models, we can offer you effective solutions that reduce costs, whilst also being efficient, user-friendly, reliable and innovative.

Another advantage we offer to our clients is a support service for systems integration projects, which we provide through our wide range of services and solutions.

As a global company, we have at our disposal the financial, logistical and technical resources to develop complex and wide-ranging solutions, both at country and international level by implementing them both on-time and on-budget.



21 of the 5-6 bedroom luxury homes in Straffan Co.Kildare, Ireland. **Aquarea**



New Hotel Monument 5*GL is located in an 1896 palace. Barcelona, Spain. **ECOi and E-Control**



New IKEA "Click and Collect" store in city centre. Birmingham, UK. **ECOi - ECO G**



LTD "Kalnenu Projektai". 77 house project in Latvia. **Aquarea**



Andalucia Technology Park. Offices of high energetic efficiency. Spain. **ECOi**



The latest glamorous Burger & Lobster restaurant in Bath. UK. **Aquarea**



Madrid's new hotel Only You Atocha. The hotel has 206 rooms distributed over seven floors. **ECO G**



Skobe Volvo with high energy savings of up to 65 %. Katrineholm, Sweden. **PACi and VRF**



Marina Village Greystones. 205 apartments and 153 houses. Ireland. **Aquarea**



The Hat, a modern hostel in Madrid. Spain. **ECO G**



Zalando's solution for its warehouse office conversion at Grand Canal Quay, Dublin. **ECOi**



Lock Building, offices for media giant Viacom. Camden, London, UK. **ECOi**

WELCOME TO AQUAREA AIR TO WATER HEAT PUMP



AQUAREA

Aquarea's new Air to Water Heat Pump for residential and commercial applications. Offering capacities from 3 kW all the way through to 16 kW, the Aquarea Heat Pump Range is the widest on the market, ensuring a system is available, whatever your heating and cooling needs. Suitable for new build and refurbishment projects, the solutions are cost-effective with minimised environmental impact.

New Aquarea H Generation A+++.

The beauty of comfort. The new H Generation is being introduced ranging from 3 to 16 kW. The small capacity units are specially designed for low energy homes and achieve an impressive COP of 5 (on the 3 kW).



New All in One H Generation.

The new All in One solution from 3 to 16 kW with 200L stainless tank with free maintenance. The "A" class pump provides a small foot print and ideal solution for new, retrofit homes.

New Mono-Bloc Generation.

The "A" class water pump equipped with the new remote controller maximises savings while improving the performance and comfort.



Aquarea Smart Cloud for Professionals.

Aquarea Smart Cloud will activate remote maintenance service while end user is controlling and monitoring its heating and DHW remotely. This remote maintenance will save time, installation visits by connecting Aquarea to a powerful cloud infrastructure. Remote checker, remote error codes, remote set up functions... all this will be possible by installers with CZ-TAW1 and end user acceptance.

Wide range of optional parts.

Wide range of quality accessories like Fan Coils and wide range of enamelled tanks and high efficiency stainless steel.



AQUAREA COMMERCIAL

Restaurant with Aquarea

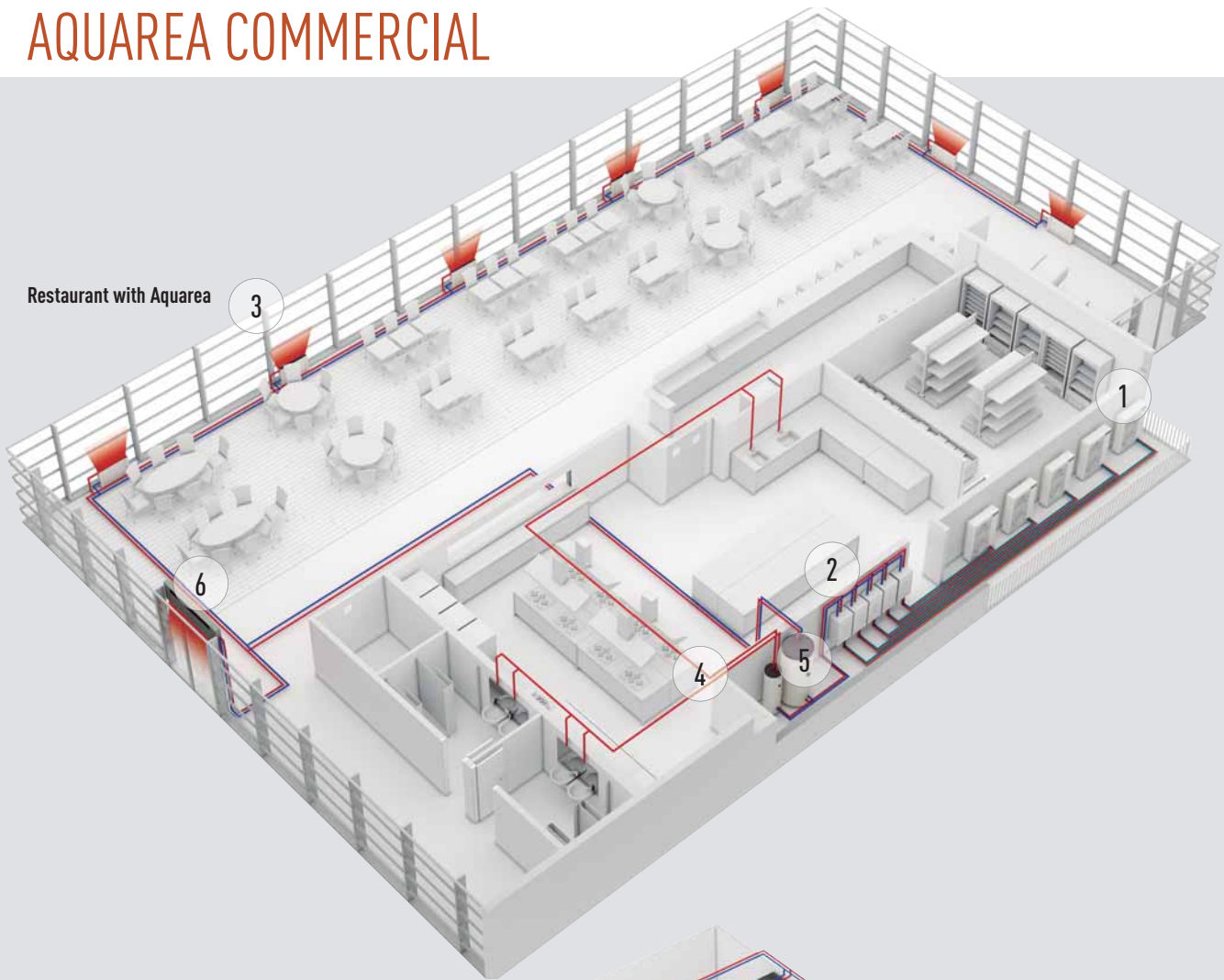

Supermarket with Aquarea

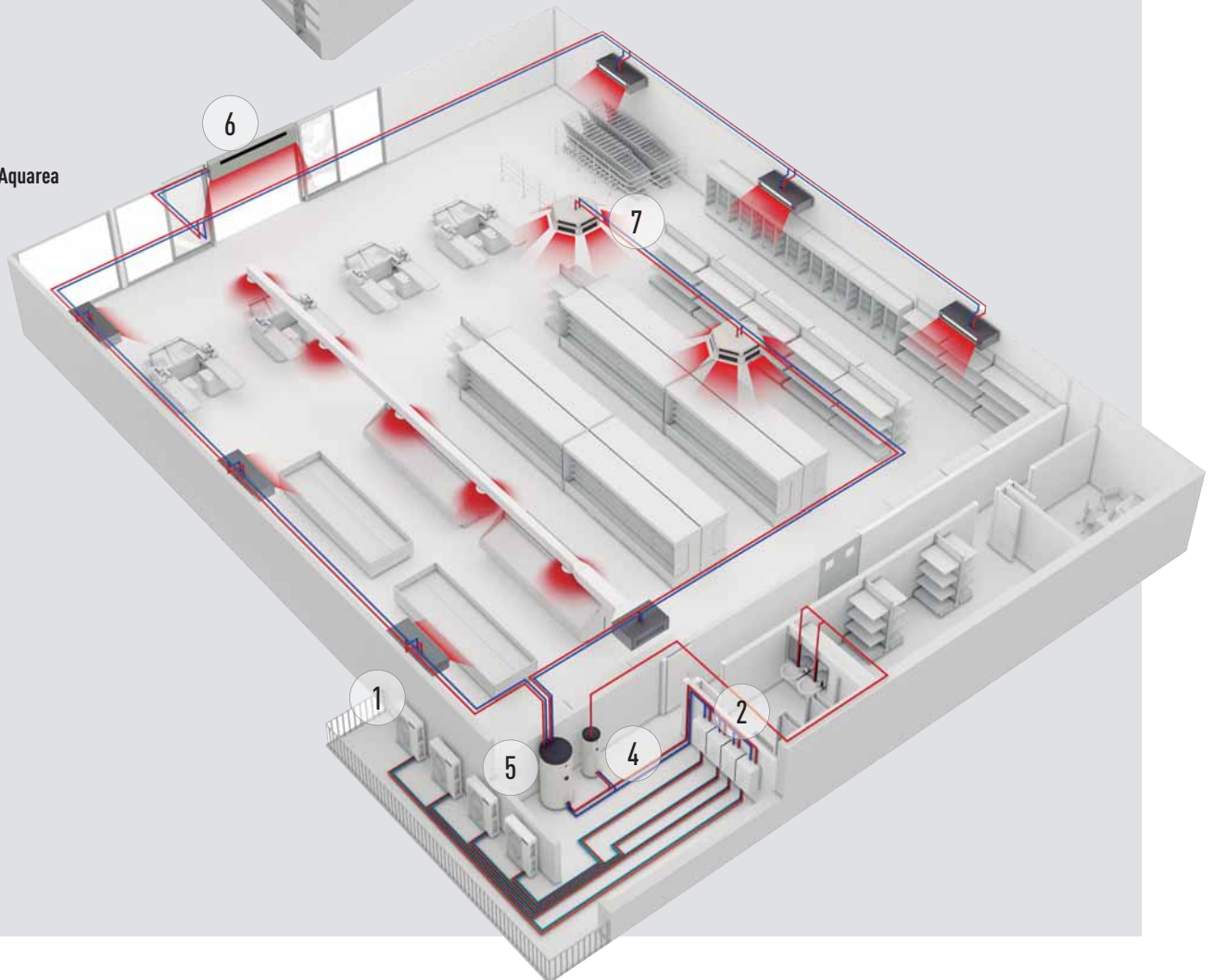

Solutions for best savings. Efficient Panasonic Heat Pumps can help to significantly reduce the energy consumption of your business. Recent improvements to air source Heat Pump technology, including compact single unit systems, can provide an ideal housing and commercial solution.

They offer space saving, energy-efficient heating and can be easily adapted for installation in flats, houses and commercial premises. Businesses producing heat, such as restaurants, installing an Aquarea Heat Pump system can also use this wasted heat to improve energy efficiency further.

Restaurant with Aquarea

If you are looking for savings for your business, Aquarea is the right choice! Ideal for heating, cooling and for production of big quantities of hot water at 65 °C, Aquarea have a quick return on investment and a low carbon footprint.

Key points:

- Produce hot water efficiency
- Fast return of investment
- Easy control

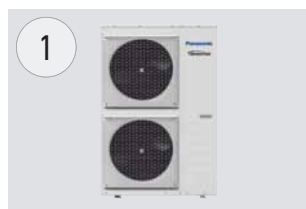

Aquarea T-CAP.
Heat Pump 16 kW on cascade mode.

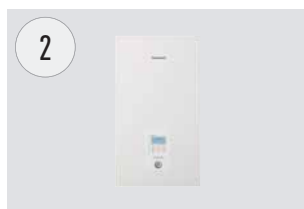

High Efficiency Aquarea Hydrokit.



High efficiency Aquarea Air radiators.
32 % more efficient than standard radiators.



New versatile and efficient fan coils.
Innovation for an optimum comfort.

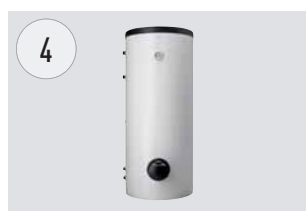

Super high efficiency Tanks.
From 200L to 500L for domestic hot water.



Buffer Tank of 1000L.



Air Curtain with DX Coil.
Designed for smooth operation and efficient performance.



Convectors.

Supermarket with Aquarea

Heat pump technology is scalable, meaning that it can be installed in buildings of varying sizes, offering both small- and large-scale heating solutions. The technology is also environmentally friendly when compared to traditional heating systems alternatives based on fossil fuel energy and in addition it is more energy efficient.

Can be integrated in the water system.

Easy connection to existing system

- Fan Coils
- Floor Heating
- 4 way and 2 way convectors
- Domestic hot water tanks
- High efficiency
- Very good part load management



AQUAREA HEAT PUMP SOLUTIONS

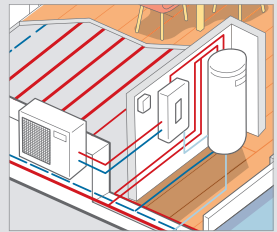
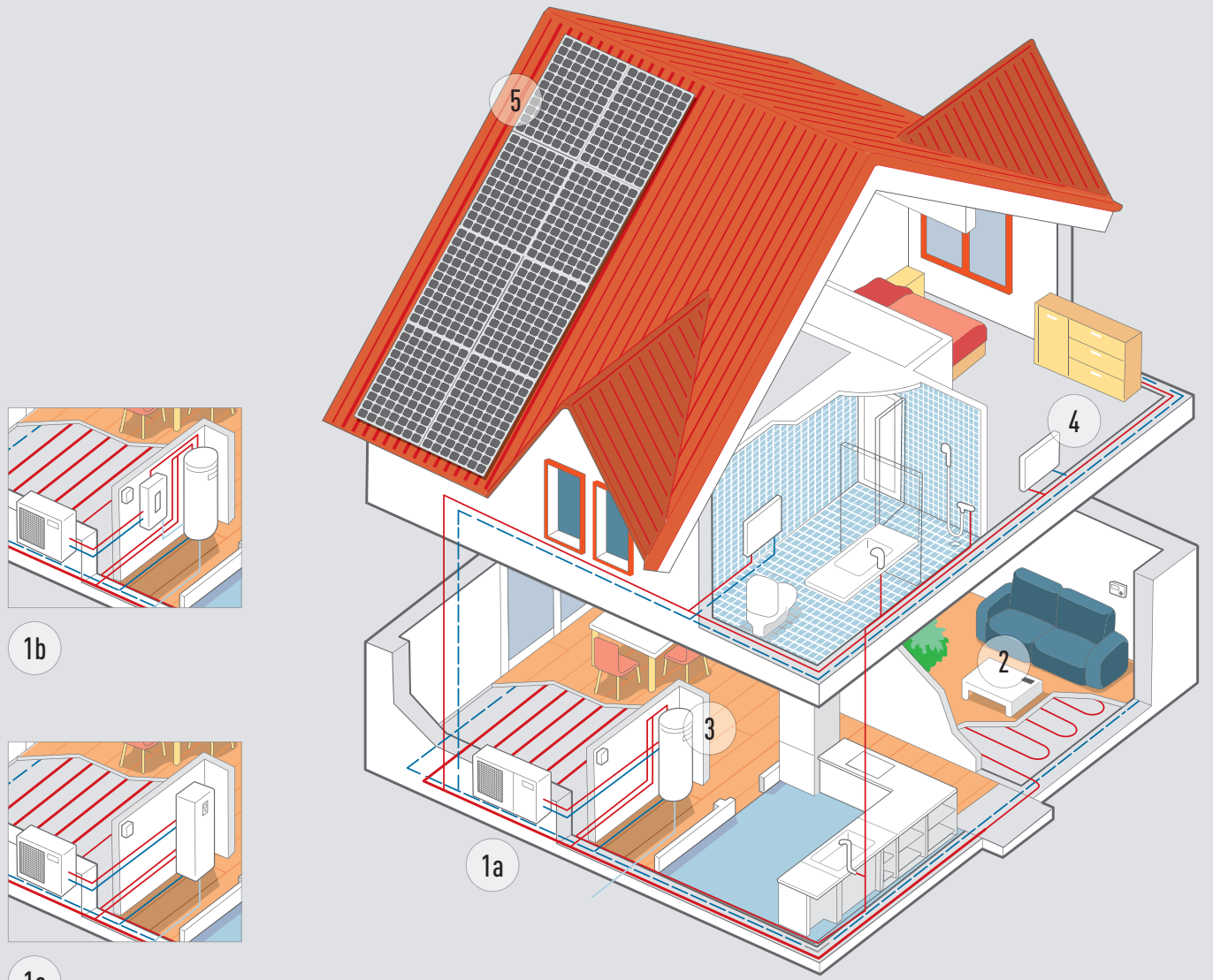

1b

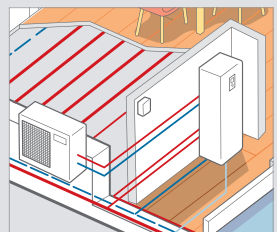

1c



1a
Mono-bloc system.

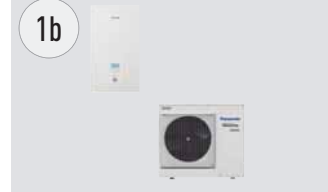

1b
Bi-bloc system.



1c
All in One system.

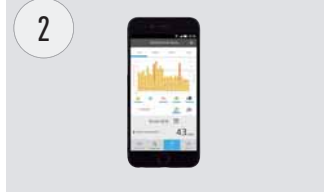

2
Control through smart phone, tablet or computer (optional).



3
Super High Efficiency cylinder (optional).



4
High efficient radiators for heating and cooling (optional).



4
New versatile and efficient fan coil (optional).



5
Heat Pump + HIT Photovoltaic solar panel (optional).

Panasonic Aquarea offers you solutions, helping to make the home more efficient and the installation cheaper and easier

Aquarea High Performance. For new installations and low consumption homes.

Outstanding efficiency and energy savings with minimised CO₂ emissions and minimum space. Improved performance with COP's up to 5,08.

Aquarea T-CAP. For extremely low temperatures, refurbishment and innovation.

Ideal to ensure that the heating capacity is maintained even at very low temperatures. This line-up is able to maintain the Heat Pump output capacity until -20 °C outdoor temperature without the help of an electrical booster heater.

Aquarea HT. For a house with old high-temperature radiators.

Ideal for retrofit: green energy source works with existing radiators. Aquarea HT Solution is the most appropriate, provides output water temperatures of 65 °C even at outdoor temperatures as low as -15 °C.

Aquarea DHW.

A energy class in all tanks.
Possible to connect to solar plant or boiler.
SG Ready available.

Aquarea High Performance	Aquarea T-CAP	Aquarea HT	Aquarea DHW
Mono-bloc Bi-bloc All in One	Mono-bloc Bi-bloc All in One	Mono-bloc Bi-bloc	
Heating - Cooling - DHW	Heating - Cooling - DHW	Heating - DHW	Only DHW
Single Phase from 3 to 16 kW Three Phase from 9 to 16 kW	Single Phase from 9 to 12 kW Three Phase from 9 to 16 kW	Single Phase from 9 to 12 kW Three Phase from 9 to 12 kW	From 80 to 295L
Connectable to			
Radiators - Fan Coil - Underfloor heating - DHW	Radiators - Fan Coil - Underfloor heating - DHW	Traditional high-temperature radiators - DHW	Domestic Hot Water
Application			
Normal installation	For extreme cold ambient	Retrofit for old radiators	Only DHW
Energy efficiency			
Heating 35 °C / 55 °C	Heating 35 °C / 55 °C	Heating 35 °C / 55 °C	Floor standing DHW 65 °C / Wall mounted DHW 55 °C
Outdoor ambient temperature limit. Operation			
-20 °C	-28 °C	-20 °C	-7 °C
Outdoor ambient temperature limit. Constant capacity (35 °C)			
-7 °C	-20 °C	-15 °C	
Supply temperature for heating. Max. / Heat pump only			
75 °C / 55 °C	75 °C / 60 °C ¹	75 °C / 65 °C	75 °C / 65 °C / 55 °C
Control and connectivity			
Smart Grid Ready ¹	Smart Grid Ready ¹	Smart Grid Ready ¹	Smart Grid Ready ¹
Wireless LAN Ready	Wireless LAN Ready	Wireless LAN Ready	
Range			
Bi-bloc from 3 to 16 kW Mono-bloc from 5 to 16 kW All in One from 3 to 16 kW (185L)	Bi-bloc from 9 to 16 kW Mono-bloc from 9 to 16 kW All in One from 9 to 16 kW (185L)	Bi-bloc from 9 to 12 kW Mono-bloc from 9 to 12 kW	From 80 to 295L

All data in this chart is applicable in most of models in each line up, check product specs to confirm. 1) H Generation with CZ-NS4P, F and G Generation with Heat Pump Manager.

AQUAREA SMART & SERVICE CLOUD

1 AQUAREA SMART CLOUD FOR END USERS



Easy and powerful energy management

The Aquarea Smart Cloud is much more than a simple thermostat for switching a heating device on or off. It is a powerful and intuitive service for remotely controlling the full range of heating and hot water functions, including monitoring energy consumption.

How does it work?

Connect Aquarea H Generation system to the cloud using wireless LAN or a wired LAN Network. User connects to the Cloud portal to remotely operate all unit functions and can also permit partners to access customised functions for remote maintenance and monitoring. See demo: <https://aquarea.aircon.panasonic.eu>

Requirements

1. H Generation Aquarea system
2. In-house internet connection with router wireless LAN or wired LAN
3. Get a Panasonic ID in <https://aquarea-smart.panasonic.com/>

Functions:

- Visualization & Control
- Scheduling
- Energy Statistics
- Malfunction notification

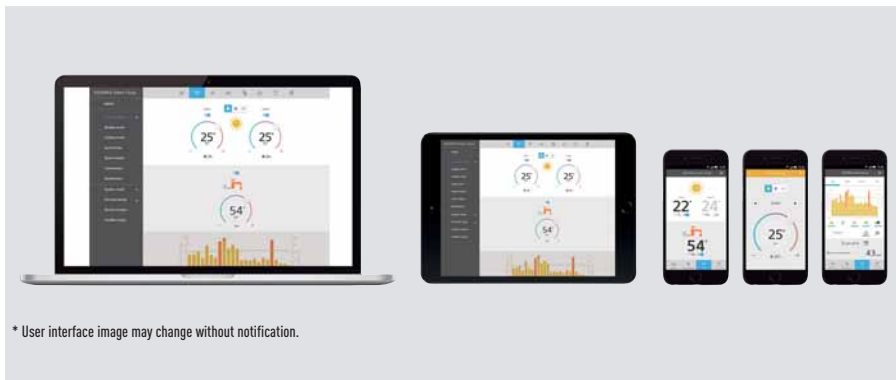

Advantages

Energy savings, comfort and control from anywhere. Increase efficiency and resources management, operating costs savings and owner satisfaction. The new Aquarea Smart Cloud services are focused on enabling full remote maintenance of the Aquarea system. This allow maintenance specialists to engage in predictive maintenance and system fine-tuning, as well as fixing malfunctions when they occur.

Aquarea compatibility	H Generation
Connection point	CN-CNT Aquarea port
Home router connection	Wireless or Wired LAN
Temperature sensor	Can use remote controller sensor
Tablet or PC browser compatibility*	Yes
Operation from remote — On/Off — House Temp setting mode selection — DHW setting — Error codes — Scheduling	Yes
Heating areas	Up to 2 zones
Power consumption estimation — Operation log history	Yes — Yes

* Check browsers and version compatibility.



The most advanced heating control for today and for the future.
 Aquarea connect to Cloud with CZ-TAW1, opening 2 different platforms.

2 AQUAREA SERVICE CLOUD FOR INSTALLERS / MAINTENANCE



The real remote maintenance made simple

The Aquarea Service Cloud allows to installers to take care remotely of their customers heating systems. Saving time, money and shortening response time increasing customer satisfaction.

Advanced functions for remote maintenance with professional screens:

- Global view at a glance
- Error log history
- Full unit information
- Statistics always available
- All settings available

Home page.

All users connected status at a glance. 2 view options: Map view or list view only.



Status tag.

Current status of unit with a maximum 28 parameters.



Statistics tag.

Customisable statistics of a maximum 73 parameters. Available anytime with the information of last 7 days.

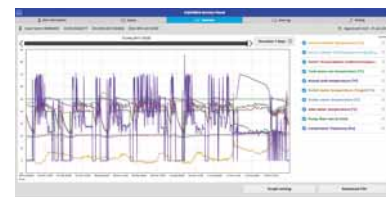

Settings tag.

Full settings of system remotely including user and installer settings.



Activation Aquarea Service Cloud

Requirements.

Hardware and connection	End user registration	Installer / maintenance registration
H Generation Aquarea connected to CZ-TAW1	Get Panasonic ID	Get Service ID
In house internet connection with Wireless LAN or Wired LAN	Aquarea Smart Cloud	Aquarea Service Cloud

Connecting unit to installer/maintenance.







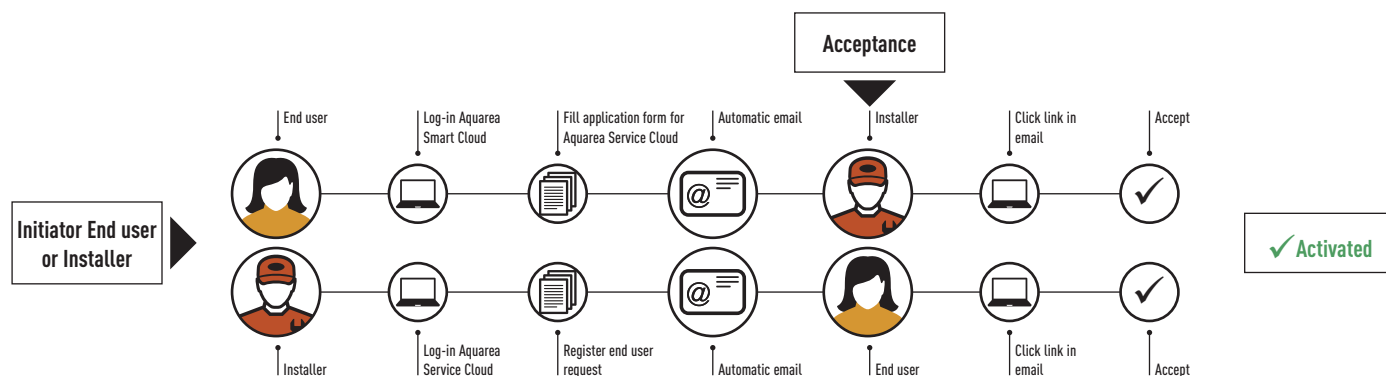











Process can be initiated either both by end user or by installer. Whenever end user can select/change level of control is giving to installer (4 levels).

Installer registration: <https://aquarea-service.panasonic.com/>

End user registration: <https://aquarea-smart.panasonic.com/>



AQUAREA HEAT PUMPS LINE-UP

		3 kW	5 kW	7 kW
Aquarea High Performance for well insulated houses 	P. 20-21 All in One Single Phase 	 WH-ADC0309H3E5 WH-ADC0309H3E5B WH-UD03HE5-1	 WH-ADC0309H3E5 WH-ADC0309H3E5B WH-UD05HE5-1	 WH-ADC0309H3E5 WH-ADC0309H3E5B WH-UD07HE5-1
	P. 24-25 Bi-bloc Single Phase Three Phase 	 WH-SDC03H3E5-1 WH-UD03HE5-1	 WH-SDC05H3E5-1 WH-UD05HE5-1	 WH-SDC07H3E5-1 WH-UD07HE5-1
	P. 28 Mono-bloc Single Phase 		 WH-MDC05H3E5	 WH-MDC07H3E5
Aquarea T-CAP High Capacity for cold areas 	P. 22-23 All in One Single Phase Three Phase 			
	P. 26-27 Bi-bloc Three Phase 			
	P. 29 Mono-bloc Three Phase 			
Aquarea HT for retrofit 	P. 30 Bi-bloc Three Phase 			
	P. 31 Mono-bloc Three Phase 			

9 kW

12 kW

16 kW



WH-ADC0309H3E5
WH-ADC0309H3E5B
WH-UD09HE5-1



WH-SDC09H3E5-1
WH-UD09HE5-1
WH-SDC09H3E8
WH-UD09HE8



WH-SDC12H9E8
WH-UD12HE8



WH-SDC16H9E8
WH-UD16HE8



WH-MDC09H3E5



WH-MDC12H6E5



WH-MDC16H6E5



WH-ADC1216H6E5
WH-UX09HE5
WH-ADC0916H9E8
WH-UX09HE8
WH-ADC0916H9E8
WH-UQ09HE8



WH-ADC1216H6E5
WH-UX12HE5
WH-ADC0916H9E8
WH-UX12HE8
WH-ADC0916H9E8
WH-UQ12HE8



WH-ADC0916H9E8
WH-UX16HE8
WH-ADC0916H9E8
WH-UQ16HE8



WH-SXC09H3E8
WH-UX09HE8
WH-SQC09H3E8
WH-UQ09HE8



WH-SXC12H9E8
WH-UX12HE8
WH-SQC12H9E8
WH-UQ12HE8



WH-SXC16H9E8
WH-UX16HE8
WH-SQC16H9E8
WH-UQ16HE8



WH-MXC09H3E8



WH-MXC12H9E8



WH-MXC16H9E8



WH-SHF09F3E8
WH-UH09FE8



WH-SHF12F9E8
WH-UH12FE8



WH-MHF09G3E8



WH-MHF12G9E8

R410A

All in One High Performance



GOOD DESIGN AWARD 2017

CZ-TAW1
Cloud connection. For user control and installer remote maintenance.



Aquarea All in One H Generation High Performance Bi-bloc Single Phase. Heating and Cooling

		Single Phase (Power to indoor)			
Kit		KIT-ADC03HE5	KIT-ADC05HE5	KIT-ADC07HE5	KIT-ADC09HE5
Heating capacity [A +7 °C, W 35 °C]	kW	3,20	5,00	7,00	9,00
COP [A +7 °C, W 35 °C]	W/W	5,00	4,63	4,46	4,13
Heating capacity [A +2 °C, W 35 °C]	kW	3,20	4,20	6,55	6,70
COP [A +2 °C, W 35 °C]	W/W	3,56	3,11	3,34	3,13
Heating capacity [A -7 °C, W 35 °C]	kW	3,20	4,20	5,15	5,90
COP [A -7 °C, W 35 °C]	W/W	2,69	2,59	2,68	2,52
Cooling capacity [A 35 °C, W 7/12 °C]	kW	3,20	4,50	6,00	7,00
EER [A 35 °C, W 7/12 °C]	W/W	3,08	2,69	2,63	2,43
Energy Efficiency Class at 35 °C ¹ / 55 °C ¹ / DHW ²		A+++ / A+++ / A	A+++ / A+++ / A	A+++ / A+++ / A	A+++ / A+++ / A
System label 35 °C / 55 °C ³		A+++ / A++	A+++ / A++	A+++ / A++	A+++ / A++
Indoor unit		WH-ADC0309H3E5	WH-ADC0309H3E5	WH-ADC0309H3E5	WH-ADC0309H3E5
Sound pressure	Heat / Cool	28/28	28/28	28/28	28/28
Dimension / Net weight	HxWxD	mm / kg	1800x598x717/124	1800x598x717/124	1800x598x717/124
Water pipe connector		Inch	R 1 1/4	R 1 1/4	R 1 1/4
A class pump	Number of speeds	Variable Speed	Variable Speed	Variable Speed	Variable Speed
	Input power (Min/Max)	W	30/120	30/120	30/120
Heating water flow (ΔT=5 K, 35 °C)		L/min	9,2	14,3	20,1
Capacity of integrated electric heater		kW	3	3	3
Recommended fuse		A	16/16	16/16	25/16
Recommended cable size, supply 1 & 2		mm ²	3 x 1,5/3 x 1,5	3 x 1,5/3 x 1,5	3 x 2,5/3 x 1,5
Water volume		L	185	185	185
Maximum water temperature		°C	65	65	65
Material inside tank			Stainless steel	Stainless steel	Stainless steel
Outdoor unit		WH-UD03HE5-1	WH-UD05HE5-1	WH-UD07HE5-1	WH-UD09HE5-1
Sound pressure	Heat / Cool	48/47	49/48	50/48	51/50
Sound power	Heat / Cool	64/65	65/66	68/66	69/68
Dimension / Net weight	HxWxD	mm / kg	622x824x298/39	622x824x298/39	795x900x320/66
Refrigerant [R410A]		kg/TCO ₂ Eq.	1,20/2,506	1,20/2,506	1,45/3,028
Pipe diameter	Liquid / Gas	Inch (mm)	1/4 (6,35)/1/2 (12,70)	1/4 (6,35)/1/2 (12,70)	1/4 (6,35)/5/8 (15,88)
Pipe length range		m	3-15	3-15	3-40
Elevation difference (in/out)		m	5	5	30
Pipe length for additional gas		m	10	10	10
Additional gas amount		g/m	20	20	30
Operation range	Outdoor ambient	°C	-20 ~ +35	-20 ~ +35	-20 ~ +35
Water outlet	Heat / Cool	°C	25-55/5-20	25-55/5-20	25-55/5-20

Accessories

PAW-ADC-CV150	Decorative magnetic side cover
CZ-NS4P	PCB for advanced functions: 0-10V demand signal, 2-zones control function, solar and external switch
PAW-ADC-PREKIT-H	Flexible pipings and wall mounting plate
PAW-GRDSTD40	Outdoor elevation platform
PAW-GRDBSE20	Outdoor base ground support for noise and vibration absorption, 20cm
CZ-NE3P	Base pan heater
PAW-WTRAY	Tray for condenser water compatible with base ground support

Accessories

CZ-TAW1	Aquarea Smart Cloud for remote control and maintenance through wireless or wired LAN
PAW-A2W-RTWIRED	Wired LCD room thermostat with weekly timer
PAW-A2W-RTWIRELESS	Wireless LCD room thermostat with weekly timer
PAW-A2W-TS0D	Outdoor ambient sensor
PAW-A2W-TSRT	Zone room sensor
PAW-A2W-TSBU	Buffer tank sensor
PAW-A2W-TSHC	Zone water sensor
PAW-A2W-TSSO	Solar sensor

EER and COP calculation is based in accordance to EN14511. Sound pressure measured at 1 m from the outdoor unit and at 1,5 m height. Heating sound pressure measured at +7 °C (heating water at 55 °C). Insulated tested under EN12897. 1) Scale from A++ to G. 2) Scale from A to G. 3) Scale from A+++ to D. System label with controller.

This product is designed to meet European water quality standard 98/93 EC. The lifespan of the product is not guaranteed in the case of the use of groundwater, such as spring water or well water, the use of tap water when salt or other impurities are contained, nor in areas of acidic water quality. Maintenance and warranty costs related to these cases are the customer's responsibility.



INTERNET CONTROL: Optional. GOOD DESIGN AWARD 2017: Indoor units All in One and Bi-bloc H Generation awarded with the prestigious Good Design Award 2017.

All in One High Performance

R410A

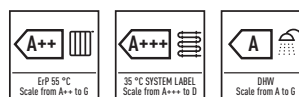

Aquarea All in One H Generation High Performance Bi-bloc Single Phase. Heating and Cooling 2 zones

			Single Phase (Power to indoor)			
Kit			KIT-ADC03HE5B	KIT-ADC05HE5B	KIT-ADC07HE5B	KIT-ADC09HE5B
Heating capacity (A +7 °C, W 35 °C)	kW		3,20	5,00	7,00	9,00
COP (A +7 °C, W 35 °C)	W/W		5,00	4,63	4,46	4,13
Heating capacity (A +2 °C, W 35 °C)	kW		3,20	4,20	6,55	6,70
COP (A +2 °C, W 35 °C)	W/W		3,56	3,11	3,34	3,13
Heating capacity (A -7 °C, W 35 °C)	kW		3,20	4,20	5,15	5,90
COP (A -7 °C, W 35 °C)	W/W		2,69	2,59	2,68	2,52
Cooling capacity (A 35 °C, W 7/12 °C)	kW		3,20	4,50	6,00	7,00
EER (A 35 °C, W 7/12 °C)	W/W		3,08	2,69	2,63	2,43
Energy Efficiency Class at 35 °C / 55 °C / DHW ²			A++ / A+ / A	A++ / A+ / A	A++ / A+ / A	A++ / A+ / A
System label 35 °C / 55 °C ³			A+++ / A++	A+++ / A++	A+++ / A++	A+++ / A++
Indoor unit			WH-ADC0309H3E5B	WH-ADC0309H3E5B	WH-ADC0309H3E5B	WH-ADC0309H3E5B
Sound pressure	Heat / Cool	dB(A)	28/28	28/28	28/28	28/28
Dimension / Net weight	HxWxD	mm / kg	1800x598x717/124	1800x598x717/124	1800x598x717/124	1800x598x717/124
Water pipe connector		Inch	R 1 1/4	R 1 1/4	R 1 1/4	R 1 1/4
A class pump	Number of speeds		Variable Speed	Variable Speed	Variable Speed	Variable Speed
	Input power (Min/Max)	W	30/120	30/120	30/120	30/120
Heating water flow (ΔT=5 K. 35 °C)		L/min	9,2	14,3	20,1	25,8
Capacity of integrated electric heater		kW	3	3	3	3
Recommended fuse		A	16/16	16/16	25/16	25/16
Recommended cable size, supply 1 & 2		mm ²	3x1,5/3x1,5	3x1,5/3x1,5	3x2,5/3x1,5	3x2,5/3x1,5
Water volume		L	185	185	185	185
Maximum water temperature		°C	65	65	65	65
Material inside tank			Stainless steel	Stainless steel	Stainless steel	Stainless steel
Outdoor unit			WH-UD03HE5-1	WH-UD05HE5-1	WH-UD07HE5-1	WH-UD09HE5-1
Sound pressure	Heat / Cool	dB(A)	48/47	49/48	50/48	51/50
Sound power	Heat / Cool	dB	64/65	65/66	68/66	69/68
Dimension / Net weight	HxWxD	mm / kg	622x824x298/39	622x824x298/39	795x900x320/66	795x900x320/66
Refrigerant (R410A)		kg/TCO ₂ Eq.	1,20/2,506	1,20/2,506	1,45/3,028	1,45/3,028
Pipe diameter	Liquid / Gas	Inch (mm)	1/4(6,35)/1/2(12,70)	1/4(6,35)/1/2(12,70)	1/4(6,35)/5/8(15,88)	1/4(6,35)/5/8(15,88)
Pipe length range		m	3-15	3-15	3-40	3-40
Elevation difference (in/out)		m	5	5	30	30
Pipe length for additional gas		m	10	10	10	10
Additional gas amount		g/m	20	20	30	30
Operation range	Outdoor ambient	°C	-20 ~ +35	-20 ~ +35	-20 ~ +35	-20 ~ +35
Water outlet	Heat / Cool	°C	25-55/5-20	25-55/5-20	25-55/5-20	25-55/5-20

Accessories

PAW-ADC-CV150	Decorative magnetic side cover
CZ-NS4P	PCB for advanced functions: 0-10V demand signal, 2-zones control function, solar and external switch
PAW-ADC-PREKIT-H	Flexible pipings and wall mounting plate
PAW-GRDSTD40	Outdoor elevation platform
PAW-GRDBSE20	Outdoor base ground support for noise and vibration absorption, 20cm
CZ-NE3P	Base pan heater
PAW-WTRAY	Tray for condenser water compatible with base ground support

Accessories

CZ-TAW1	Aquarea Smart Cloud for remote control and maintenance through wireless or wired LAN
PAW-A2W-RTWIRED	Wired LCD room thermostat with weekly timer
PAW-A2W-RTWIRELESS	Wireless LCD room thermostat with weekly timer
PAW-A2W-TSOD	Outdoor ambient sensor
PAW-A2W-TSRIT	Zone room sensor
PAW-A2W-TSBU	Buffer tank sensor
PAW-A2W-TSHC	Zone water sensor
PAW-A2W-TSSO	Solar sensor

EER and COP calculation is based in accordance to EN14511. Sound pressure measured at 1 m from the outdoor unit and at 1,5 m height. Heating sound pressure measured at +7 °C (heating water at 55 °C). Insulated tested under EN12897. 1) Scale from A++ to G. 2) Scale from A to G. 3) Scale from A+++ to D. System label with controller. This product is designed to meet European water quality standard 98/93 EC. The lifespan of the product is not guaranteed in the case of the use of groundwater, such as spring water or well water, the use of tap water when salt or other impurities are contained, nor in areas of acidic water quality. Maintenance and warranty costs related to these cases are the customer's responsibility.



INTERNET CONTROL: Optional. GOOD DESIGN AWARD 2017: Indoor units All in One and Bi-bloc H Generation awarded with the prestigious Good Design Award 2017.



GOOD DESIGN AWARD 2017



CZ-TAW1
Cloud connection. For user control and installer remote maintenance.



Aquarea All in One H Generation T-CAP Bi-bloc Single Phase / Three Phase. Heating and Cooling

Kit	Single Phase (Power to indoor)			Three Phase (Power to indoor)		
	KIT-AXC9HE5	KIT-AXC12HE5	KIT-AXC9HE8	KIT-AXC12HE8	KIT-AXC16HE8	
Heating capacity [A +7 °C, W 35 °C]	kW	9,00	12,00	9,00	12,00	16,00
COP [A +7 °C, W 35 °C]	W/W	4,84	4,74	4,84	4,74	4,28
Heating capacity [A +2 °C, W 35 °C]	kW	9,00	12,00	9,00	12,00	16,00
COP [A +2 °C, W 35 °C]	W/W	3,59	3,44	3,59	3,44	3,10
Heating capacity [A -7 °C, W 35 °C]	kW	9,00	12,00	9,00	12,00	16,00
COP [A -7 °C, W 35 °C]	W/W	2,85	2,72	2,85	2,72	2,49
Cooling capacity [A 35 °C, W 7/12 °C]	kW	7,00	10,00	7,00	10,00	12,20
EER [A 35 °C, W 7/12 °C]	W/W	3,17	2,81	3,17	2,81	2,57
Energy Efficiency Class at 35 °C ¹ / 55 °C ¹ / DHW ²		A++ / A++ / A	A++ / A++ / A	A++ / A++ / A	A++ / A++ / A	A++ / A++ / A
System label 35 °C / 55 °C ³		A+++ / A++	A+++ / A++	A+++ / A++	A+++ / A++	A+++ / A++
Indoor unit		WH-ADC1216H6E5	WH-ADC1216H6E5	WH-ADC0916H9E8	WH-ADC0916H9E8	WH-ADC0916H9E8
Sound pressure	Heat / Cool	dB(A)	33/33	33/33	33/33	33/33
Dimension / Net weight	HxWxD	mm / kg	1800x598x717/124	1800x598x717/124	1800x598x717/126	1800x598x717/126
Water pipe connector		Inch	R 1 1/4	R 1 1/4	R 1 1/4	R 1 1/4
A class pump	Number of speeds		Variable Speed	Variable Speed	Variable Speed	Variable Speed
	Input power (Min/Max)	W	36/152	36/152	36/152	36/152
Heating water flow (ΔT=5 K, 35 °C)		L/min	25,8	34,4	25,8	34,4
Capacity of integrated electric heater		kW	6	6	9	9
Recommended fuse		A	30/30	30/30	20/20	20/20
Recommended cable size, supply 1 & 2		mm ²	3x4,0/3x4,0	3x4,0/3x4,0	5x1,5/5x1,5	5x1,5/5x1,5
Water volume		L	185	185	185	185
Maximum water temperature		°C	65	65	65	65
Material inside tank			Stainless steel	Stainless steel	Stainless steel	Stainless steel
Outdoor unit			WH-UX09HE5	WH-UX12HE5	WH-UX09HE8	WH-UX12HE8
Sound pressure	Heat / Cool	dB(A)	51/49	52/50	51/49	52/50
Sound power	Heat / Cool	dB	68/67	69/68	68/67	69/68
Dimension / Net weight	HxWxD	mm / kg	1340x900x320/101	1340x900x320/101	1340x900x320/108	1340x900x320/108
Refrigerant [R410A]		kg/TCO ₂ Eq.	2,85/5,951	2,85/5,951	2,85/5,951	2,85/5,951
Pipe diameter	Liquid / Gas	Inch (mm)	3/8(9,52)/5/8(15,88)	3/8(9,52)/5/8(15,88)	3/8(9,52)/5/8(15,88)	3/8(9,52)/5/8(15,88)
Pipe length range		m	3~30	3~30	3~30	3~30
Elevation difference (in/out)		m	20	20	20	20
Pipe length for additional gas		m	10	10	10	10
Additional gas amount		g/m	50	50	50	50
Operation range	Outdoor ambient	°C	-28~+35	-28~+35	-28~+35	-28~+35
Water outlet	Heat / Cool	°C	25~60/5~20	25~60/5~20	25~60/5~20	25~60/5~20

Accessories

PAW-ADC-CV150	Decorative magnetic side cover
CZ-NS4P	PCB for advanced functions: 0-10V demand signal, 2-zones control function, solar and external switch
PAW-ADC-PREKIT-H	Flexible pipings and wall mounting plate
PAW-GRDSTD40	Outdoor elevation platform
PAW-GRDBSE20	Outdoor base ground support for noise and vibration absorption, 20cm
CZ-NE3P	Base pan heater
PAW-WTRAY	Tray for condenser water compatible with base ground support

Accessories

CZ-TAW1	Aquarea Smart Cloud for remote control and maintenance through wireless or wired LAN
PAW-A2W-RTWIRED	Wired LCD room thermostat with weekly timer
PAW-A2W-RTWIRELESS	Wireless LCD room thermostat with weekly timer
PAW-A2W-TS0D	Outdoor ambient sensor
PAW-A2W-TSRT	Zone room sensor
PAW-A2W-TSBU	Buffer tank sensor
PAW-A2W-TSHC	Zone water sensor
PAW-A2W-TSSO	Solar sensor

EER and COP calculation is based in accordance to EN14511. Sound pressure measured at 1 m from the outdoor unit and at 1,5 m height. Heating sound pressure measured at +7 °C (heating water at 55 °C). Insulated tested under EN12897. 1) Scale from A++ to G. 2) Scale from A to G. 3) Scale from A+++ to D. System label with controller.

This product is designed to meet European water quality standard 98/93 EC. The lifespan of the product is not guaranteed in the case of the use of groundwater, such as spring water or well water, the use of tap water when salt or other impurities are contained, nor in areas of acidic water quality. Maintenance and warranty costs related to these cases are the customer's responsibility.



INTERNET CONTROL: Optional. GOOD DESIGN AWARD 2017: Indoor units All in One and Bi-bloc H Generation awarded with the prestigious Good Design Award 2017.

All in One T-CAP

R410A



GOOD DESIGN AWARD 2017



NEW 18



NEW Aquarea All in One H Generation T-CAP Bi-bloc Three Phase. Super Quiet outdoor unit. Heating and Cooling

			Three Phase (Power to indoor)		
Kit			KIT-AQC9HE8	KIT-AQC12HE8	KIT-AQC16HE8
Heating capacity (A +7 °C, W 35 °C)	kW		9,00	12,00	16,00
COP (A +7 °C, W 35 °C)	W/W		4,84	4,74	4,28
Heating capacity (A +2 °C, W 35 °C)	kW		9,00	12,00	16,00
COP (A +2 °C, W 35 °C)	W/W		3,59	3,44	3,10
Heating capacity (A -7 °C, W 35 °C)	kW		9,00	12,00	16,00
COP (A -7 °C, W 35 °C)	W/W		2,85	2,72	2,49
Cooling capacity (A 35 °C, W 7/12 °C)	kW		7,00	10,00	12,20
EER (A 35 °C, W 7/12 °C)	W/W		3,17	2,81	2,57
Energy Efficiency Class at 35 °C ¹ / 55 °C ¹ / DHW ²			◀A++ / ◀A++ / ◀A	◀A++ / ◀A++ / ◀A	◀A++ / ◀A++ / ◀A
System label 35 °C / 55 °C ³			◀A+++ / ◀A+++	◀A+++ / ◀A+++	◀A+++ / ◀A+++
Indoor unit			WH-ADC0916H9E8	WH-ADC0916H9E8	WH-ADC0916H9E8
Sound pressure	Heat / Cool	dB(A)	33/33	33/33	33/33
Dimension / Net weight	HxWxD	mm / kg	1800x598x717/126	1800x598x717/126	1800x598x717/126
Water pipe connector		Inch	R 1 1/4	R 1 1/4	R 1 1/4
A class pump	Number of speeds		Variable Speed	Variable Speed	Variable Speed
	Input power (Min/Max)	W	36/152	36/152	36/152
Heating water flow (ΔT=5 K, 35 °C)		L/min	25,8	34,4	45,9
Capacity of integrated electric heater		kW	9	9	9
Recommended fuse		A	20/20	20/20	20/20
Recommended cable size, supply 1 & 2		mm ²	5x1,5/5x1,5	5x1,5/5x1,5	5x1,5/5x1,5
Water volume		L	185	185	185
Maximum water temperature		°C	65	65	65
Material inside tank			Stainless steel	Stainless steel	Stainless steel
Outdoor unit			WH-UQ09HE8	WH-UQ12HE8	WH-UQ16HE8
Sound pressure	Heat / Cool	dB(A)	47/48	48/49	51/53
Sound power	Heat / Cool	dB	61/63	62/64	65/68
Dimension / Net weight	HxWxD	mm / kg	1410x1283x320/151	1410x1283x320/151	1410x1283x320/161
Refrigerant (R410A)		kg/TCO ₂ Eq.	2,85/5,951	2,85/5,951	2,99/6,243
Pipe diameter	Liquid / Gas	Inch (mm)	3/8 (9,52)/5/8 (15,88)	3/8 (9,52)/5/8 (15,88)	3/8 (9,52)/5/8 (15,88)
Pipe length range		m	3-30	3-30	3-30
Elevation difference (in/out)		m	20	20	20
Pipe length for additional gas		m	10	10	10
Additional gas amount		g/m	50	50	50
Operation range	Outdoor ambient	°C	-28 ~ +35	-28 ~ +35	-28 ~ +35
Water outlet	Heat / Cool	°C	20-60/5-20	20-60/5-20	20-60/5-20

Accessories

PAW-ADC-CV150	Decorative magnetic side cover
CZ-NS4P	PCB for advanced functions: 0-10V demand signal, 2-zones control function, solar and external switch
PAW-ADC-PREKIT-H	Flexible pipings and wall mounting plate
PAW-GRDSTD40	Outdoor elevation platform
PAW-GRDBSE20	Outdoor base ground support for noise and vibration absorption, 20cm
CZ-NE3P	Base pan heater
PAW-WTRAY	Tray for condenser water compatible with base ground support

Accessories

CZ-TAW1	Aquarea Smart Cloud for remote control and maintenance through wireless or wired LAN
PAW-A2W-RTWIRED	Wired LCD room thermostat with weekly timer
PAW-A2W-RTWIRELESS	Wireless LCD room thermostat with weekly timer
PAW-A2W-TSOD	Outdoor ambient sensor
PAW-A2W-TSR1	Zone room sensor
PAW-A2W-TSBU	Buffer tank sensor
PAW-A2W-TSHC	Zone water sensor
PAW-A2W-TSSO	Solar sensor

EER and COP calculation is based in accordance to EN14511. Sound pressure measured at 1 m from the outdoor unit and at 1,5 m height. Heating sound pressure measured at +7 °C (heating water at 55 °C). Insulated (tested under EN12897. 1) Scale from A++ to G. 2) Scale from A to G. 3) Scale from A+++ to D. System label with controller.

This product is designed to meet European water quality standard 98/93 EC. The lifespan of the product is not guaranteed in the case of the use of groundwater, such as spring water or well water, the use of tap water when salt or other impurities are contained, nor in areas of acidic water quality. Maintenance and warranty costs related to these cases are the customer's responsibility.



INTERNET CONTROL: Optional. GOOD DESIGN AWARD 2017: Indoor units All in One and Bi-bloc H Generation awarded with the prestigious Good Design Award 2017.

R410A

Bi-bloc High Performance



GOOD DESIGN AWARD 2017



CZ-TAW1
Cloud connection. For user control and installer remote maintenance.



Aquarea H Generation High Performance Bi-bloc Single Phase. Heating and Cooling - SDC

		Single Phase Heating and Cooling				
Kit		KIT-WC03H3E5	KIT-WC05H3E5	KIT-WC07H3E5	KIT-WC09H3E5	
Heating capacity [A +7 °C, W 35 °C]	kW	3,20	5,00	7,00	9,00	
COP [A +7 °C, W 35 °C]	W/W	5,00	4,63	4,46	4,13	
Heating capacity [A +2 °C, W 35 °C]	kW	3,20	4,20	6,55	6,70	
COP [A +2 °C, W 35 °C]	W/W	3,56	3,11	3,34	3,13	
Heating capacity [A -7 °C, W 35 °C]	kW	3,20	4,20	5,15	5,90	
COP [A -7 °C, W 35 °C]	W/W	2,69	2,59	2,68	2,52	
Cooling capacity [A 35 °C, W 7/12 °C]	kW	3,20	4,50	6,00	7,00	
EER [A 35 °C, W 7/12 °C]	W/W	3,08	2,69	2,63	2,43	
Energy Efficiency Class at 35 °C ¹ / 55 °C ²		A++* / A++	A++* / A++	A+++* / A+++	A+++* / A+++	
System label 35 °C / 55 °C ²		A+++ / A++	A+++ / A++	A+++ / A++	A+++ / A++	
Indoor unit		WH-SDC03H3E5-1	WH-SDC05H3E5-1	WH-SDC07H3E5-1	WH-SDC09H3E5-1	
Sound pressure	Heat / Cool	28/28	28/28	30/30	30/30	
Dimension	HxWxD	892x500x340	892x500x340	892x500x340	892x500x340	
Net weight		44	44	44	44	
Water pipe connector		R 1 1/4	R 1 1/4	R 1 1/4	R 1 1/4	
A class pump	Number of speeds	Variable Speed	Variable Speed	Variable Speed	Variable Speed	
	Input power (Min/Max)	30/100	33/106	34/114	40/120	
Heating water flow (ΔT=5 K, 35 °C)	L/min	9,2	14,3	20,1	25,8	
Capacity of integrated electric heater	kW	3	3	3	3	
Recommended fuse	A	16/16	16/16	30/30	30/30	
Recommended cable size, supply 1 & 2	mm ²	3x1,5/3x1,5	3x1,5/3x1,5	3x2,5/3x2,5	3x2,5/3x2,5	
Outdoor unit		WH-UD03HE5-1	WH-UD05HE5-1	WH-UD07HE5-1	WH-UD09HE5-1	
Sound pressure	Heat / Cool	48/47	49/48	50/48	51/50	
Sound power	Heat / Cool	64/65	65/66	68/66	69/68	
Dimension	HxWxD	622x824x298	622x824x298	795x900x320	795x900x320	
Net weight		39	39	66	66	
Refrigerant (R410A)	kg/TCO ₂ Eq.	1,20/2,506	1,20/2,506	1,45/3,028	1,45/3,028	
Pipe diameter	Liquid / Gas	Inch (mm)	1/4 (6,35) / 1/2 (12,70)	1/4 (6,35) / 1/2 (12,70)	1/4 (6,35) / 5/8 (15,88)	1/4 (6,35) / 5/8 (15,88)
Pipe length range		m	3 - 15	3 - 15	3 - 40	3 - 40
Elevation difference (in/out)		m	5	5	30	30
Pipe length for additional gas		m	10	10	10	10
Additional gas amount		g/m	20	20	30	30
Operation range	Outdoor ambient	°C	-20 ~ +35	-20 ~ +35	-20 ~ +35	-20 ~ +35
Water outlet	Heat / Cool	°C	25 - 55/5 - 20	25 - 55/5 - 20	25 - 55/5 - 20	25 - 55/5 - 20

Accessories

PAW-TD20C1E5	Oso Tank 200 L - Stainless steel
PAW-TD30C1E5	Oso Tank 300 L - Stainless steel
PAW-TD20B8E3-1	Tank 185 L (for DHW tank) / 80 L (for buffer tank)
CZ-TK1	Temperature sensor for 3rd party tank
CZ-NV1	3 way valve Kit for inside of hydrokit
CZ-NS4P	Additional functions PCB
PAW-BTANK50L	Buffer tank 50L
CZ-TAW1	Aquarea Smart Cloud for remote control and maintenance through wireless or wired LAN

Accessories

PAW-A2W-RTWIRED	Room thermostat
PAW-A2W-TSOD	Outdoor ambient sensor
PAW-A2W-TSRT	Zone room sensor
PAW-A2W-TSBU	Buffer tank sensor
PAW-A2W-TSHC	Zone water sensor
PAW-A2W-TSSO	Solar sensor
PAW-A2WLOGGER	Data Logger: With this tool we can log data during a long period
PAW-A2WCHECKER	Service checker: With this tool we will have a life monitoring at our PC

EER and COP calculation is based in accordance to EN14511. Sound pressure measured at 1 m from the outdoor unit and at 1,5 m height. Remark to energy efficiency class: These indications are based on the official ErP regulations (EU regulations N° 811/2013, EN14511 and EN14825) for heat pumps, which is officially binding from September 2015. Efficiency classes marked with * would meet the new regulations from September 2019 to a classification as A+++.



INTERNET CONTROL: Optional. GOOD DESIGN AWARD 2017: Indoor units ALL in One and Bi-bloc H Generation awarded with the prestigious Good Design Award 2017.

Bi-bloc High Performance

R410A

GOOD
DESIGN
AWARD
2017

Aquaera H Generation High Performance Bi-bloc Three Phase. Heating and Cooling - SDC

			Three Phase (Power to indoor)		
Kit			KIT-WC09H3E8	KIT-WC12H9E8	KIT-WC16H9E8
Heating capacity (A +7 °C, W 35 °C)	kW		9,00	12,00	16,00
COP (A +7 °C, W 35 °C)	W/W		4,84	4,74	4,28
Heating capacity (A +2 °C, W 35 °C)	kW		9,00	11,40	13,00
COP (A +2 °C, W 35 °C)	W/W		3,59	3,44	3,28
Heating capacity (A -7 °C, W 35 °C)	kW		9,00	10,00	11,40
COP (A -7 °C, W 35 °C)	W/W		2,85	2,73	2,57
Cooling capacity (A 35 °C, W 7/12 °C)	kW		7,00	10,00	12,20
EER (A 35 °C, W 7/12 °C)	W/W		3,17	2,81	2,56
Energy Efficiency Class at 35 °C ¹ / 55 °C ¹			A++ / A++	A++ / A++	A++ / A++
System label 35 °C / 55 °C ²			A+++ / A++	A+++ / A++	A+++ / A++
Indoor unit			WH-SDC09H3E8	WH-SDC12H9E8	WH-SDC16H9E8
Sound pressure	Heat / Cool	dB(A)	33/33	33/33	33/33
Dimension	HxWxD	mm	892x500x340	892x500x340	892x500x340
Net weight		kg	44	45	45
Water pipe connector		Inch	R 1 1/4	R 1 1/4	R 1 1/4
A class pump	Number of speeds		Variable Speed	Variable Speed	Variable Speed
	Input power (Min/Max)	W	32/102	34/110	30/105
Heating water flow (ΔT=5 K, 35 °C)		L/min	25,8	34,4	45,9
Capacity of integrated electric heater		kW	3	9	9
Recommended fuse		A	20/16	20/20	20/20
Recommended cable size, supply 1 & 2		mm ²	5x1,5/3x1,5	5x1,5/5x1,5	5x1,5/5x1,5
Outdoor unit			WH-UD09HE8	WH-UD12HE8	WH-UD16HE8
Sound pressure	Heat / Cool	dB(A)	51/49	52/50	55/54
Sound power	Heat / Cool	dB	68/67	69/68	72/72
Dimension	HxWxD	mm	1340x900x320	1340x900x320	1340x900x320
Net weight		kg	107	107	107
Refrigerant (R410A)		kg/CO ₂ Eq.	2,55/5,324	2,55/5,324	2,55/5,324
Pipe diameter	Liquid / Gas	Inch (mm)	3/8 (9,52) / 5/8 (15,88)	3/8 (9,52) / 5/8 (15,88)	3/8 (9,52) / 5/8 (15,88)
Pipe length range		m	3-30	3-30	3-30
Elevation difference (in/out)		m	30	30	30
Pipe length for additional gas		m	10	10	10
Additional gas amount		g/m	50	50	50
Operation range	Outdoor ambient	°C	-20 ~ +35	-20 ~ +35	-20 ~ +35
Water outlet	Heat / Cool	°C	25-55/5-20	25-55/5-20	25-55/5-20

Accessories

PAW-TD20C1E5	Oso Tank 200 L - Stainless steel
PAW-TD30C1E5	Oso Tank 300 L - Stainless steel
PAW-TD20B8E3-1	Tank 185 L (for DHW tank) / 80 L (for buffer tank)
CZ-TK1	Temperature sensor for 3rd party tank
CZ-NV1	3 way valve Kit for inside of hydrokit
CZ-NS4P	Additional functions PCB
PAW-BTANK50L	Buffer tank 50L
CZ-TAW1	Aquaera Smart Cloud for remote control and maintenance through wireless or wired LAN

Accessories

PAW-A2W-RTWIRED	Room thermostat
PAW-A2W-TSOD	Outdoor ambient sensor
PAW-A2W-TSRT	Zone room sensor
PAW-A2W-TSBU	Buffer tank sensor
PAW-A2W-TSHC	Zone water sensor
PAW-A2W-TSSO	Solar sensor
PAW-A2WLOGGER	Data Logger: With this tool we can log data during a long period
PAW-A2WCHECKER	Service checker: With this tool we will have a life monitoring at our PC

EER and COP calculation is based in accordance to EN14511. Sound pressure measured at 1 m from the outdoor unit and at 1,5 m height. Heating sound pressure measured at +7 °C (heating water at 55 °C). 1) Scale from A++ to G. 2) Scale from A+++ to D. System label with controller.



INTERNET CONTROL: Optional. GOOD DESIGN AWARD 2017: Indoor units All in One and Bi-bloc H Generation awarded with the prestigious Good Design Award 2017.

R410A

Bi-bloc T-CAP



GOOD DESIGN AWARD 2017



CZ-TAW1
Cloud connection. For user control and installer remote maintenance.



Aquarea H Generation T-CAP Bi-bloc Three Phase. Heating and Cooling - SXC

			Three Phase (Power to indoor)		
Kit			KIT-WXC09H3E8	KIT-WXC12H9E8	KIT-WXC16H9E8
Heating capacity [A +7 °C, W 35 °C]	kW		9,00	12,00	16,00
COP [A +7 °C, W 35 °C]	W/W		4,84	4,74	4,28
Heating capacity [A +2 °C, W 35 °C]	kW		9,00	12,00	16,00
COP [A +2 °C, W 35 °C]	W/W		3,59	3,44	3,10
Heating capacity [A -7 °C, W 35 °C]	kW		9,00	12,00	16,00
COP [A -7 °C, W 35 °C]	W/W		2,85	2,72	2,49
Cooling capacity [A 35 °C, W 7 °C]	kW		7,00	10,00	12,20
EER [A 35 °C, W 7 °C]	W/W		3,17	2,81	2,57
Energy Efficiency Class at 35 °C ¹ / 55 °C ¹			A++ / A++	A+++ / A+++	A+++ / A+++
System label 35 °C / 55 °C ²			A+++ / A+++	A+++ / A+++	A+++ / A+++
Indoor unit			WH-SXC09H3E8	WH-SXC12H9E8	WH-SXC16H9E8
Sound pressure	Heat / Cool	dB(A)	33/33	33/33	33/33
Dimension	HxWxD	mm	892 x 500 x 340	892 x 500 x 340	892 x 500 x 340
Net weight		kg	43	44	45
Water pipe connector		Inch	R 1 1/4	R 1 1/4	R 1 1/4
A class pump	Number of speeds		Variable Speed	Variable Speed	Variable Speed
	Input power (Min/Max)	W	32/102	34/110	30/105
Heating water flow (ΔT=5 K, 35 °C)		L/min	25,8	34,4	45,9
Capacity of integrated electric heater		kW	3	9	9
Recommended fuse		A	20/16	20/20	20/20
Recommended cable size, supply 1 & 2		mm ²	5 x 1,5/3 x 1,5	5 x 1,5/5 x 1,5	5 x 1,5/5 x 1,5
Outdoor unit			WH-UX09HE8	WH-UX12HE8	WH-UX16HE8
Sound pressure	Heat / Cool	dB(A)	51/49	52/50	55/54
Sound power	Heat / Cool	dB	68/67	69/68	72/71
Dimension	HxWxD	mm	1340 x 900 x 320	1340 x 900 x 320	1340 x 900 x 320
Net weight		kg	108	108	118
Refrigerant [R410A]		kg/TCO ₂ Eq.	2,85/5,951	2,85/5,951	2,90/6,055
Pipe diameter	Liquid / Gas	Inch (mm)	3/8 (9,52)/5/8 (15,88)	3/8 (9,52)/5/8 (15,88)	3/8 (9,52)/5/8 (15,88)
Pipe length range		m	3-30	3-30	3-30
Elevation difference (in/out)		m	30	30	30
Pipe length for additional gas		m	10	10	10
Additional gas amount		g/m	50	50	50
Operation range	Outdoor ambient	°C	-28 ~ +35	-28 ~ +35	-28 ~ +35
Water outlet	Heat / Cool	°C	25 - 60/5 - 20	25 - 60/5 - 20	25 - 60/5 - 20

Accessories

PAW-TD20C1E5	Oso Tank 200 L - Stainless steel
PAW-TD30C1E5	Oso Tank 300 L - Stainless steel
PAW-TD20B8E3-1	Tank 185 L (for DHW tank) / 80 L (for buffer tank)
CZ-TK1	Temperature sensor for 3rd party tank
CZ-NV1	3 way valve Kit for inside of hydrokit
CZ-NS4P	Additional functions PCB
PAW-BTANK50L	Buffer tank 50L
CZ-TAW1	Aquarea Smart Cloud for remote control and maintenance through wireless or wired LAN

Accessories

PAW-A2W-RTWIRED	Room thermostat
PAW-A2W-TSOD	Outdoor ambient sensor
PAW-A2W-TSRT	Zone room sensor
PAW-A2W-TSBU	Buffer tank sensor
PAW-A2W-TSHC	Zone water sensor
PAW-A2W-TSSO	Solar sensor
PAW-A2WLOGGER	Data Logger: With this tool we can log data during a long period
PAW-A2WCHECKER	Service checker: With this tool we will have a life monitoring at our PC

EER and COP calculation is based in accordance to EN14511. Sound pressure measured at 1 m from the outdoor unit and at 1,5 m height. Heating sound pressure measured at +7 °C (heating water at 55 °C). 1) Scale from A++ to G. 2) Scale from A+++ to D. System label with controller.



INTERNET CONTROL: Optional. GOOD DESIGN AWARD 2017: Indoor units ALL in One and Bi-bloc H Generation awarded with the prestigious Good Design Award 2017.

Bi-bloc T-CAP

R410A

GOOD
DESIGN
AWARD
2017CZ-TAW1
Cloud connection. For user control
and installer remote maintenance.

Aquaera H Generation T-CAP Bi-bloc Three Phase. Super Quiet outdoor unit. Heating and Cooling - SQC

Kit	Three Phase New Super Quiet outdoor unit				
	KIT-WQC09H3E8	KIT-WQC12H9E8	KIT-WQC16H9E8		
Heating capacity (A +7 °C, W 35 °C)	kW	9,00	12,00	16,00	
COP (A +7 °C, W 35 °C)	W/W	4,84	4,74	4,28	
Heating capacity (A +2 °C, W 35 °C)	kW	9,00	12,00	16,00	
COP (A +2 °C, W 35 °C)	W/W	3,59	3,44	3,10	
Heating capacity (A -7 °C, W 35 °C)	kW	9,00	12,00	16,00	
COP (A -7 °C, W 35 °C)	W/W	2,85	2,72	2,49	
Cooling capacity (A 35 °C, W 7 °C)	kW	7,00	10,00	12,20	
EER (A 35 °C, W 7 °C)	W/W	3,17	2,81	2,57	
Energy Efficiency Class at 35 °C ¹ / 55 °C ¹		A++ / A++	A++ / A++	A++ / A++	
System label 35 °C / 55 °C ²		A+++ / A+++	A+++ / A+++	A+++ / A+++	
Indoor unit		WH-SQC09H3E8	WH-SQC12H9E8	WH-SQC16H9E8	
Sound pressure	Heat / Cool	dB(A)	33/33	33/33	33/33
Dimension	HxWxD	mm	892x500x340	892x500x340	892x500x340
Net weight		kg	43	44	45
Water pipe connector		Inch	R 1 1/4	R 1 1/4	R 1 1/4
A class pump	Number of speeds		Variable Speed	Variable Speed	Variable Speed
	Input power (Min/Max)	W	32/102	34/110	30/105
Heating water flow (ΔT=5 K, 35 °C)		L/min	25,8	34,4	45,9
Capacity of integrated electric heater		kW	3	9	9
Recommended fuse		A	20/16	20/20	20/20
Recommended cable size, supply 1 & 2		mm ²	5x1,5/3x1,5	5x1,5/5x1,5	5x1,5/5x1,5
Outdoor unit		WH-UQ09HE8	WH-UQ12HE8	WH-UQ16HE8	
Sound pressure	Heat / Cool	dB(A)	47/48	48/49	51/53
Sound power	Heat / Cool	dB	61/63	62/64	65/68
Dimension	HxWxD	mm	1410x1283x320	1410x1283x320	1410x1283x320
Net weight		kg	151	151	161
Refrigerant (R410A)		kg/TCO ₂ Eq.	2,85/5,951	2,85/5,951	2,99/6,243
Pipe diameter	Liquid / Gas	Inch (mm)	3/8(9,52)/5/8(15,88)	3/8(9,52)/5/8(15,88)	3/8(9,52)/5/8(15,88)
Pipe length range		m	3-30	3-30	3-30
Elevation difference (in/out)		m	20	20	20
Pipe length for additional gas		m	10	10	10
Additional gas amount		g/m	50	50	50
Operation range	Outdoor ambient	°C	-28 ~ +35	-28 ~ +35	-28 ~ +35
Water outlet	Heat / Cool	°C	20 - 60/5 - 20	20 - 60/5 - 20	20 - 60/5 - 20

Accessories

PAW-TD20C1E5	Oso Tank 200 L - Stainless steel
PAW-TD30C1E5	Oso Tank 300 L - Stainless steel
PAW-TD20B8E3-1	Tank 185 L (for DHW tank) / 80 L (for buffer tank)
CZ-TK1	Temperature sensor for 3rd party tank
CZ-NV1	3 way valve Kit for inside of hydrokit
CZ-NS4P	Additional functions PCB
PAW-BTANK50L	Buffer tank 50L
CZ-TAW1	Aquaera Smart Cloud for remote control and maintenance through wireless or wired LAN

Accessories

PAW-A2W-RTWIRED	Room thermostat
PAW-A2W-TSOD	Outdoor ambient sensor
PAW-A2W-TSRT	Zone room sensor
PAW-A2W-TSBU	Buffer tank sensor
PAW-A2W-TSHC	Zone water sensor
PAW-A2W-TSSO	Solar sensor
PAW-A2WLOGGER	Data Logger: With this tool we can log data during a long period
PAW-A2WCHECKER	Service checker: With this tool we will have a life monitoring at our PC

EER and COP calculation is based in accordance to EN14511. Sound pressure measured at 1 m from the outdoor unit and at 1,5 m height. Heating sound pressure measured at +7 °C (heating water at 55 °C). 1) Scale from A++ to G. 2) Scale from A+++ to D. System label with controller.



INTERNET CONTROL: Optional. GOOD DESIGN AWARD 2017: Indoor units All in One and Bi-bloc H Generation awarded with the prestigious Good Design Award 2017.

R410A

Mono-bloc High Performance



CZ-TAW1
Cloud connection. For user control and installer remote maintenance.



Aquarea H Generation High Performance Mono-bloc Single Phase. Heating and Cooling - MDC

Single Phase Heating and Cooling

Outdoor unit			WH-MDC05H3E5	WH-MDC07H3E5	WH-MDC09H3E5	WH-MDC12H6E5	WH-MDC16H6E5
Heating capacity [A +7 °C, W 35 °C]	kW		5,00	7,00	9,00	12,00	16,00
COP [A +7 °C, W 35 °C]	W/W		5,08	4,52	4,29	4,74	4,28
Heating capacity [A +2 °C, W 35 °C]	kW		4,80	6,60	6,80	11,40	13,00
COP [A +2 °C, W 35 °C]	W/W		3,36	3,30	3,18	3,44	3,28
Heating capacity [A -7 °C, W 35 °C]	kW		4,70	5,50	6,40	10,00	11,40
COP [A -7 °C, W 35 °C]	W/W		2,85	2,70	2,60	2,73	2,57
Cooling capacity [A 35 °C, W 7 °C]	kW		4,50	6,00	7,00	10,00	12,20
EER [A 35 °C, W 7 °C]	W/W		3,28	2,78	2,60	2,81	2,56
Energy Efficiency Class at 35 °C ¹ / 55 °C ¹			A++ / A++	A++ / A++	A++ / A++	A++ / A++	A++ / A++
System label 35 °C / 55 °C ²			A+++ / A++	A+++ / A++	A+++ / A++	A+++ / A++	A+++ / A++
Sound pressure Heat / Cool	dB(A)		49 / 47	50 / 48	51 / 49	52 / 50	55 / 54
Sound power Heat / Cool	dB		65 / 65	68 / 66	69 / 67	69 / 68	72 / 72
Dimension H x W x D	mm		865 x 1283 x 320	865 x 1283 x 320	865 x 1283 x 320	1410 x 1283 x 320	1410 x 1283 x 320
Net weight	kg		94	104	104	140	140
Refrigerant (R410A) ³	kg / TCO ₂ Eq.		1,30 / 2714	1,35 / 2819	1,35 / 2819	2,10 / 4,385	2,10 / 4,385
Water pipe connector	Inch		R 1 1/4	R 1 1/4	R 1 1/4	R 1 1/4	R 1 1/4
A class pump	Number of speeds		Variable Speed	Variable Speed	Variable Speed	Variable Speed	Variable Speed
	Input power (Min/Max) W		34 / 96	36 / 100	39 / 108	34 / 110	38 / 120
Heating water flow (ΔT=5 K, 35 °C)	L/min		14,3	20,1	25,8	34,4	45,9
Capacity of integrated electric heater	kW		3	3	3	6	6
Input Power	Heat kW		0,985	1,55	2,10	2,53	3,74
	Cool kW		1,37	2,16	2,69	3,56	4,76
Running and Starting current	Heat A		4,7	7,2	9,6	11,7	16,9
	Cool A		6,3	9,9	12,2	16,2	21,5
Current 1	A		13,0	21,0	22,9	24,0	26,0
Current 2	A		13,0	13,0	13,0	26,0	26,0
Recommended fuse	A		16 / 16	25 / 16	25 / 16	30 / 30	30 / 30
Recommended cable size, supply 1 & 2	mm ²		3 x 1,5 / 3 x 1,5	3 x 2,5 / 3 x 1,5	3 x 2,5 / 3 x 1,5	3 x 4,0 / 3 x 4,0	3 x 4,0 / 3 x 4,0
Operation range	Outdoor ambient °C		-20 ~ +35	-20 ~ +35	-20 ~ +35	-20 ~ +35	-20 ~ +35
Water outlet	Heat °C		20 ~ 55	20 ~ 55	20 ~ 55	25 ~ 55	25 ~ 55
	Cool °C		5 ~ 20	5 ~ 20	5 ~ 20	5 ~ 20	5 ~ 20

Accessories

PAW-TD20C1E5	Oso Tank 200 L - Stainless steel
PAW-TD30C1E5	Oso Tank 300 L - Stainless steel
PAW-TD20B8E3-1	Tank 185 L (for DHW tank) / 80 L (for buffer tank)
CZ-TK1	Temperature sensor for 3rd party tank
PAW-BTANK50L	Buffer tank 50L
CZ-NE1P	Base pan heater for Mono-Bloc 5 kW
CZ-NE3P	Base pan heater for Mono-Bloc 9, 12, 16 kW

Accessories

CZ-TAW1	Aquarea Smart Cloud for remote control and maintenance through wireless or wired LAN
PAW-A2W-RTWIRED	Room thermostat
PAW-GRDBSE20	Outdoor base ground support for noise and vibration absorption, 20cm
PAW-WTRAY	Tray for condenser water compatible with base ground support
PAW-GRDSTD40	Outdoor elevation platform

EER and COP calculation is based in accordance to EN14511. Sound pressure measured at 1 m from the outdoor unit and at 1,5 m height. Heating sound pressure measured at +7 °C (heating water at 55 °C). Authorized service partner or Authorized installer can enable the cooling mode through a special operation via the remote controller on site. 1) Scale from A++ to G. 2) Scale from A+++ to D. System label with controller. 3) WH-MDC models are hermetically sealed.



INTERNET CONTROL: Optional.

Mono-bloc T-CAP

R410A

NEW
18
CZ-TAW1
 Cloud connection. For user control and installer remote maintenance.

NEW Aquarea H Generation T-CAP Mono-bloc Three Phase. Heating and Cooling - MXC

Tentative data

			Three Phase		
Outdoor unit			WH-MXC09H3E8	WH-MXC12H9E8	WH-MXC16H9E8
Heating capacity (A +7 °C, W 35 °C)	kW		9,00	12,00	16,00
COP (A +7 °C, W 35 °C)	W/W		4,84	4,74	4,28
Heating capacity (A +2 °C, W 35 °C)	kW		9,00	12,00	16,00
COP (A +2 °C, W 35 °C)	W/W		3,59	3,44	3,10
Heating capacity (A -7 °C, W 35 °C)	kW		9,00	12,00	16,00
COP (A -7 °C, W 35 °C)	W/W		2,85	2,72	2,49
Cooling capacity (A 35 °C, W 7 °C)	kW		7,00	10,00	12,20
EER (A 35 °C, W 7 °C)	W/W		3,17	2,81	2,56
Energy Efficiency Class at 35 °C ¹ / 55 °C ¹			A++ / A++	A++ / A++	A++ / A++
System label 35 °C / 55 °C ²			—	—	—
Sound pressure	Heat / Cool	dB(A)	51 / 49	52 / 50	55 / 54
Sound power	Heat / Cool	dB	68 / 67	69 / 68	72 / 71
Dimension	H x W x D	mm	1410 x 1283 x 320	1410 x 1283 x 320	1410 x 1283 x 320
Net weight		kg	151	151	164
Refrigerant (R410A) ³		kg/TCO ₂ Eq.	2,30/4,802	2,30/4,802	2,35/4,907
Water pipe connector		Inch	R 1 1/4	R 1 1/4	R 1 1/4
A class pump	Number of speeds		Variable Speed	Variable Speed	Variable Speed
	Input power (Min/Max)	W	32/102	34/110	38/120
Heating water flow (ΔT=5 K, 35 °C)		L/min	25,8	34,4	45,9
Capacity of integrated electric heater		kW	3	9	9
Input Power	Heat	kW	1,86	2,53	3,74
	Cool	kW	2,21	3,56	4,76
Running and Starting current	Heat	A	3,0	4,0	5,7
	Cool	A	3,5	5,3	7,1
Current 1		A	14,7	11,9	15,5
Current 2		A	13,0	13,0	13,0
Recommended fuse		A	20/16	20/20	20/20
Recommended cable size, supply 1 & 2		mm ²	5 x 1,5/3 x 2,5	5 x 1,5/5 x 1,5	5 x 1,5/5 x 1,5
Operation range	Outdoor ambient	°C	-27 ~ +35	-27 ~ +35	-27 ~ +35
	Heat	°C	25 ~ 60	25 ~ 60	25 ~ 60
Water outlet	Heat	°C	25 ~ 60	25 ~ 60	25 ~ 60
	Cool	°C	5 ~ 20	5 ~ 20	5 ~ 20

Accessories

PAW-TD20C1E5	Oso Tank 200 L - Stainless steel
PAW-TD30C1E5	Oso Tank 300 L - Stainless steel
PAW-TD20B8E3-1	Tank 185 L (for DHW tank) / 80 L (for buffer tank)
CZ-TK1	Temperature sensor for 3rd party tank
PAW-BTANK50L	Buffer tank 50L
CZ-NE1P	Base pan heater for Mono-Bloc 5 kW
CZ-NE3P	Base pan heater for Mono-Bloc 9, 12, 16 kW

Accessories

CZ-TAW1	Aquarea Smart Cloud for remote control and maintenance through wireless or wired LAN
PAW-A2W-RTWIRED	Room thermostat
PAW-GRDBSE20	Outdoor base ground support for noise and vibration absorption, 20cm
PAW-WTRAY	Tray for condenser water compatible with base ground support
PAW-GRDSTD40	Outdoor elevation platform

EER and COP calculation is based in accordance to EN14511. Sound pressure measured at 1 m from the outdoor unit and at 1,5 m height. Heating sound pressure measured at +7 °C (heating water at 55 °C). 1) Scale from A++ to G. 2) Scale from A+++ to D. System label with controller. 3) WH-MXC models are hermetically sealed. * Tentative data.



INTERNET CONTROL: Optional.

R407C

Bi-bloc HT



Aquarea HT F Generation Bi-bloc Three Phase. Heating Only - SHF

Kit	Three Phase (Power to indoor)		
		KIT-WHF09F3E8	KIT-WHF12F9E8
Heating capacity [A +7 °C, W 35 °C]	kW	9,00	12,00
COP [A +7 °C, W 35 °C]	W/W	4,64	4,46
Heating capacity [A +2 °C, W 35 °C]	kW	9,00	12,00
COP [A +2 °C, W 35 °C]	W/W	3,45	3,26
Heating capacity [A -7 °C, W 35 °C]	kW	9,00	12,00
COP [A -7 °C, W 35 °C]	W/W	2,74	2,52
Heating capacity [A +7 °C, W 65 °C]	kW	9,00	12,00
COP [A +7 °C, W 65 °C]	W/W	2,48	2,41
Heating capacity [A +2 °C, W 65 °C]	kW	9,00	10,30
COP [A +2 °C, W 65 °C]	W/W	2,06	2,01
Heating capacity [A -7 °C, W 65 °C]	kW	9,00	9,60
COP [A -7 °C, W 65 °C]	W/W	1,79	1,77
Energy Efficiency Class at 35 °C ¹ / 55 °C ²		A++ / A++	A++ / A++
System label 35 °C / 55 °C ²		A++ / A++	A++ / A++
Indoor unit		WH-SHF09F3E8	WH-SHF12F9E8
Sound pressure	dB(A)	33	33
Dimension	HxWxD	mm 892 x 502 x 353	mm 892 x 502 x 353
Net weight	kg	47	48
Water pipe connector	Inch	R 1 1/4	R 1 1/4
Pump	Number of speeds	7	7
	Input power (Min/Max)	W 38 / 100	W 40 / 106
Heating water flow (ΔT=5 K, 35 °C)	L/min	25,8	34,4
Capacity of integrated electric heater	kW	3	9
Recommended fuse	A	20/16	20/20
Recommended cable size, supply 1 & 2	mm ²	5 x 1,5/3 x 1,5	5 x 1,5/5 x 1,5
Outdoor unit		WH-UH09FE8	WH-UH12FE8
Sound pressure	dB(A)	51	52
Sound power	dB	66	67
Dimension	HxWxD	mm 1340 x 900 x 320	mm 1340 x 900 x 320
Net weight	kg	110	110
Refrigerant (R407C)	kg/TCO ₂ Eq.	2,90/5,145	2,90/5,145
Pipe diameter	Liquid / Gas	Inch (mm) 3/8(9,52)/5/8(15,88)	Inch (mm) 3/8(9,52)/5/8(15,88)
Pipe length range	m	3 - 30	3 - 30
Elevation difference (in/out)	m	20	20
Pipe length for additional gas	m	10	10
Additional gas amount	g/m	70	70
Operation range	Outdoor ambient	°C -27 ~ +35	°C -27 ~ +35
Water outlet	°C	25 ~ 65	25 ~ 65

Accessories

PAW-TD20C1E5	Oso Tank 200 L - Stainless steel
PAW-TD30C1E5	Oso Tank 300 L - Stainless steel
PAW-TD20B8E3-1	Tank 185 L (for DHW tank) / 80 L (for buffer tank)
CZ-TK1	Temperature sensor for 3rd party tank
PAW-BTANK50L	Buffer tank 50L

Accessories

PA-AW-WIFI-1TE	WLAN interface
PAW-A2W-BIV	Bivalent controller
PAW-FILTER	2 check valves + filter with 1"
PAW-A2W-RTWIRED	Room thermostat

EER and COP calculation is based in accordance to EN14511. Sound pressure measured at 1 m from the outdoor unit and at 1,5 m height. Heating sound pressure measured at +7 °C (heating water at 55 °C). 1) Scale from A++ to G. 2) Scale from A+++ to D. System label with controller.



INTERNET CONTROL: Optional.

Mono-bloc HT

R407C

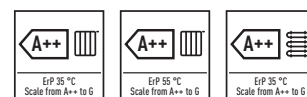

Aquarea G Generation HT Mono-bloc Three Phase. Heating Only - MHF

Three Phase

Outdoor unit		WH-MHF09G3E5	WH-MHF12G6E5
Heating capacity (A +7 °C, W 35 °C)	kW	9,00	12,00
COP (A +7 °C, W 35 °C)	W/W	4,64	4,46
Heating capacity (A +2 °C, W 35 °C)	kW	9,00	12,00
COP (A +2 °C, W 35 °C)	W/W	3,45	3,26
Heating capacity (A -7 °C, W 35 °C)	kW	9,00	12,00
COP (A -7 °C, W 35 °C)	W/W	2,74	2,52
Heating capacity (A +7 °C, W 65 °C)	kW	9,00	12,00
COP (A +7 °C, W 65 °C)	W/W	2,29	2,22
Heating capacity (A +2 °C, W 65 °C)	kW	9,00	10,30
COP (A +2 °C, W 65 °C)	W/W	1,89	1,84
Heating capacity (A -7 °C, W 65 °C)	kW	8,90	9,60
COP (A -7 °C, W 65 °C)	W/W	1,63	1,62
Energy Efficiency Class at 35 °C ¹ / 55 °C ¹		A+++	A+++
System label 35 °C / 55 °C ²		A+++	A+++
Sound pressure	dB(A)	51	52
Sound power	dB	68	69
Dimension	HxWxD	mm	1410 x 1283 x 320
Net weight		kg	151
Refrigerant (R407C) ³	kg / TCO ₂ Eq.		1,92/3,406
Water pipe connector		Inch	R 1 1/4
Pump	Number of speeds		7
	Input power (Min/Max)	W	—
Heating water flow (ΔT=5 K, 35 °C)		L/min	25,8
Capacity of integrated electric heater		kW	3
Input Power		kW	1,94
Running and Starting current		A	9,3
Recommended fuse		A	40 / 40
Recommended cable size, supply 1 & 2		mm ²	3 x 4,0 / 3 x 4,0
Operation range	Outdoor ambient	°C	-27 ~ +35
Water outlet		°C	25 - 65

Accessories

PAW-TD20C1E5	Oso Tank 200 L - Stainless steel
PAW-TD30C1E5	Oso Tank 300 L - Stainless steel
PAW-TD20B8E3-1	Tank 185 L (for DHW tank) / 80 L (for buffer tank)
CZ-TK1	Temperature sensor for 3rd party tank
PAW-BTANK50L	Buffer tank 50L
CZ-NE1P	Base pan heater for Mono-Bloc 5 kW
CZ-NE3P	Base pan heater for Mono-Bloc 9, 12, 16 kW
PA-AW-WIFI-1TE	WLAN interface

Accessories

PAW-A2W-BIV	Bivalent controller
PAW-FILTER	2 check valves + filter with 1"
PAW-A2W-RTWIRED	Room thermostat
PAW-GRDBSE20	Outdoor base ground support for noise and vibration absorption, 20cm
PAW-WTRAY	Tray for condenser water compatible with base ground support
PAW-GRDSTD40	Outdoor elevation platform

EER and COP calculation is based in accordance to EN14511. Sound pressure measured at 1 m from the outdoor unit and at 1,5 m height. Heating sound pressure measured at +7 °C (heating water at 55 °C). 1) Scale from A+++ to G. 2) Scale from A+++ to D. System label with controller. 3) WH-MHF models are hermetically sealed.



INTERNET CONTROL: Optional.

AQUAREA VENTILATION



Panasonic All in One combines with the Aquarea heat recovery ventilation unit

- The right combination: an efficient heat recovery system and an efficient heat pump
- The best comfort and the best temperature in the house in summer and in winter
- The best air quality in the house

Panasonic has designed a highly efficient heat recovery unit in order to provide the best solution for demanding house builders and house owners who are looking for high performance and reliability.

Panasonic All in One, Best in Tests

- Easy to install
- Highly efficient domestic hot water production
- Small outdoor unit
- For heating and cooling the homes
- Panasonic has an installation and servicing network which covers the whole of Sweden

The Aquarea ventilation unit is compact and efficient

- Easy to install
- Highly efficient heat recovery system (89,4 % recovery)
- Up to 350 m³/h
- Extremely silent unit
- For heating and cooling the home
- No cold air in rooms as all cool air is heated
- Very good ventilation and air quality in the house

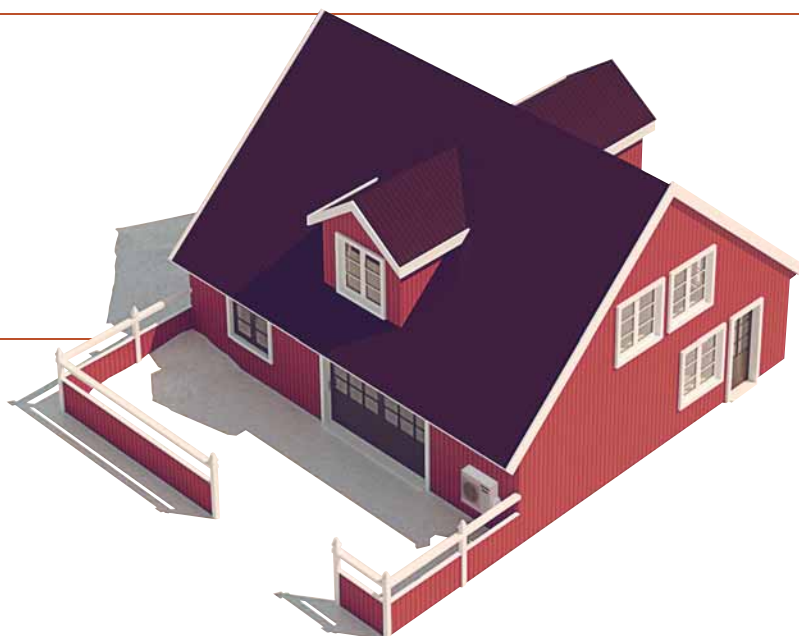

Having a heat pump is associated with comfort and savings.
However, not all heat pumps offer the same comfort.

Other brands

The main problem with exhaust air heat pumps is lack of comfort due to cold air entering bedrooms without preheating. This creates an extremely low level of comfort.

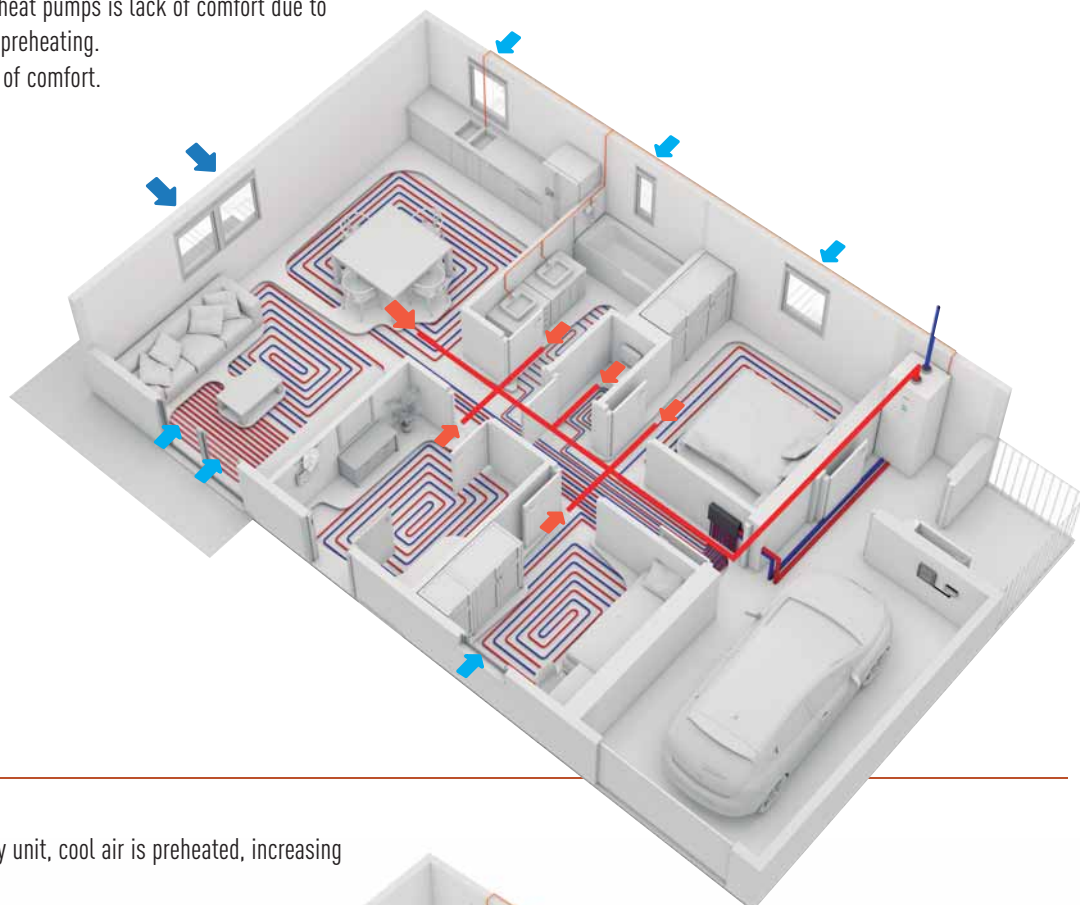

Panasonic Aquarea solutions

Thanks to Panasonic's heat recovery unit, cool air is preheated, increasing comfort.

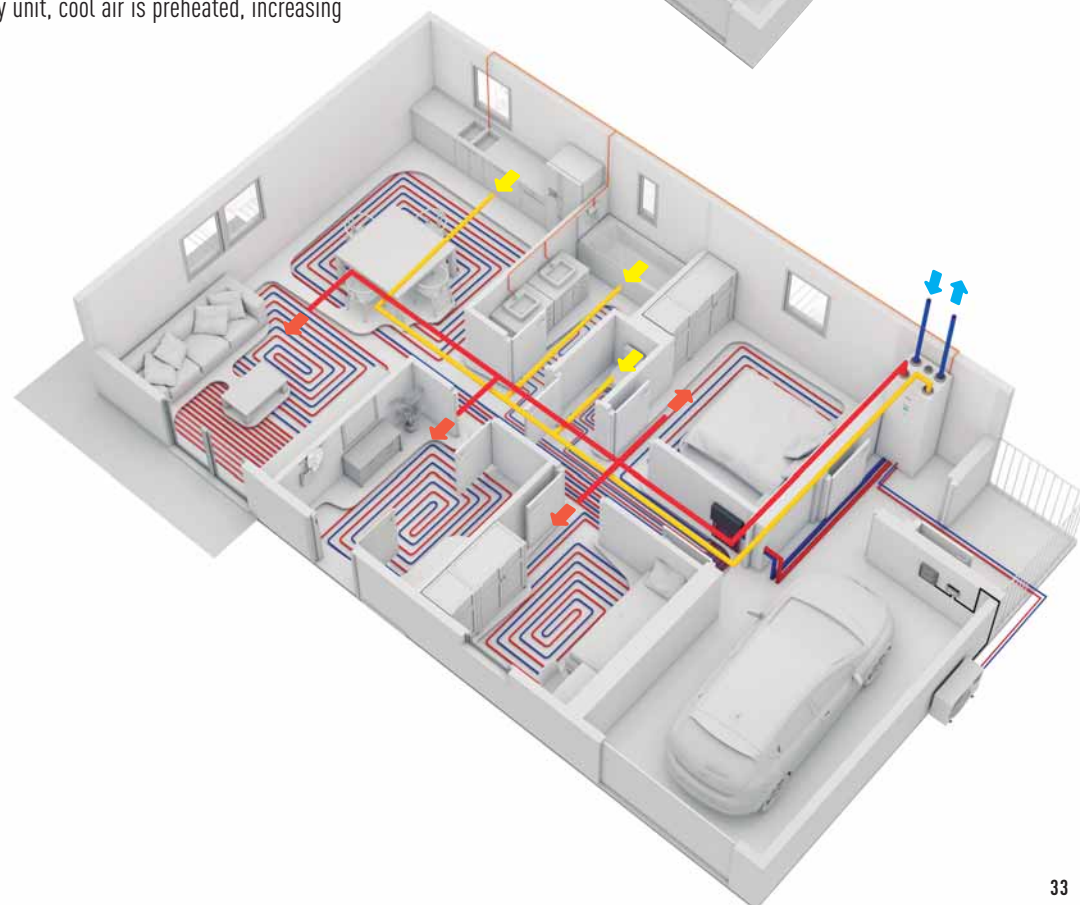
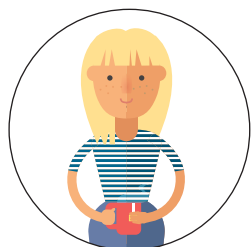



Aquarea Air Radiators. Fan Coils for Heat Pump application

Fan Coils for Heat Pump application		PAW-AAIR-200-1					PAW-AAIR-700-1					PAW-AAIR-900-1				
Total heating capacity	W	138,00	160,00	217,00	470,00	570,00	223,00	360,00	708,00	1032,00	1188,00	273,00	475,00	886,00	1420,00	1703,00
Water flow	kg/h	23,70	27,50	37,30	80,80	98,00	38,40	61,90	121,80	177,50	204,30	47,00	81,70	152,40	244,20	292,90
Water pressure drop	kPa	0,10	0,20	0,40	2,00	2,90	0,10	0,10	0,30	0,80	1,00	0,10	0,20	0,50	1,60	2,20
	m ³ /min	0,50	0,60	0,90	1,90	2,70	0,70	1,40	2,60	4,20	5,30	0,90	1,80	4,10	6,10	7,70
Air flow	Speed	Main Fan Off	Super Min	Min	Med	Max	Main Fan Off	Super Min	Min	Med	Max	Main Fan Off	Super Min	Min	Med	Max
		3,00	9,00	14,00	18,00	22,00	3,00	9,00	14,00	18,00	22,00	3,00	11,00	16,00	20,00	24,00
Maximum input power	W	2,00	5,00	7,00	9,00	13,00	3,00	9,00	14,00	18,00	22,00	3,00	11,00	16,00	20,00	24,00
Sound pressure	dB(A)	17,60	18,80	24,70	33,20	39,40	18,40	19,60	25,80	34,10	40,20	18,40	22,30	26,20	34,40	42,20
Inlet water temperature	°C	35	35	35	35	35	35	35	35	35	35	35	35	35	35	35
Outlet water temperature	°C	30	30	30	30	30	30	30	30	30	30	30	30	30	30	30
Inlet air temperature	°C	19,00	19,00	19,00	19,00	19,00	19,00	19,00	19,00	19,00	19,00	19,00	19,00	19,00	19,00	19,00
Outlet air temperature	°C	34,50	32,60	38,90	32,00	30,00	34,90	32,40	33,30	31,80	30,60	34,80	32,50	30,20	31,10	30,60
Dimension (H x W x D)	mm	735 x 579 x 129					935 x 579 x 129					1135 x 579 x 129				
Net weight	kg	17					20					23				
3 ways valve included		Yes					Yes					Yes				
Touch screen thermostat		Yes					Yes					Yes				

New line up of Super low temperature radiators for Heat Pump application: Aquarea Air 200/700/900 with radiating effect

The slimline Panasonic Aquarea Air radiators deliver high efficiency climate control.

With a depth of just under 13 cm they are at the cutting edge of the market. Blending easily into the home, Aquarea Air's elegant design and product refinements are clear to see in every detail. Exceptional ventilation efficiency means the motor uses considerably less energy (low wattage). The fan speed is continuously modulated by the temperature controller with proportional integral logic, with undoubted advantages for regulating the temperature and humidity in summer mode.



With standard cast radiators.

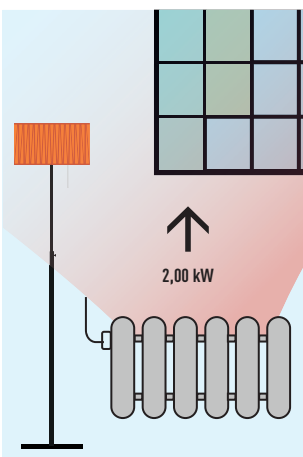

Water at 65 °C needed.

With Aquarea Air.

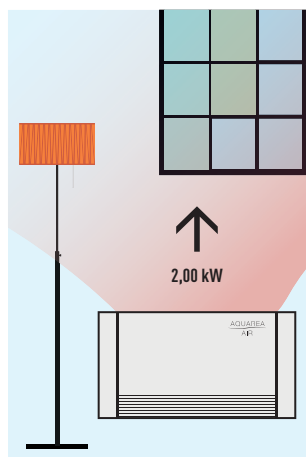

Water at 35 °C needed.

Technical focus:

- Front panel heating with radiant effect
- High heating capacity (without main fan running)
- 4 fan speeds and capacities
- Exclusive design
- Extremely compact (only 12,9 cm deep)
- Cooling and dehumidification functions possible (drain is needed)
- 3-way valve included (no overflow valve needed on the installation if more than 3 radiators installed)
- Touch screen thermostat

All temperature curves and capacity are available on www.panasonicproclub.com

FAN COILS



NEW
18

NEW Fan Coils

Tentative data

Model	Compact units						High Static Pressure	
		PAW-FC-D24	PAW-FC-D40	PAW-FC-D55	PAW-FC-D65	PAW-FC-D90	PAW-FC-H150	
Total Cooling capacity	Med / S-Hi	kW	2,00/2,40	3,10/4,10	4,20/5,50	5,80/6,60	6,70/9,10	11,90/14,80
Sensible cooling	Med / S-Hi	kW	1,70/2,10	2,20/3,00	3,00/4,00	4,30/5,00	4,90/7,00	9,60/12,90
Heating capacity	Med / S-Hi	kW	2,40/3,00	3,90/5,40	4,00/5,30	7,40/8,70	9,30/12,60	14,90/19,90
Power consumption	S-Lo / Med / S-Hi	W	24/50/81	33/57/86	39/76/112	60/114/161	90/112/188	180/421/675
Fuse rating		A	2,00	2,00	2,00	2,00	2,00	3,17
Dimensions	H x W x D	mm	220x624x430	220x994x430	220x1179x430	220x994x530	220x1250x530	356x1380x798
Dimensions (including pan and electrical box)	H x W x D	mm	220x862x430	220x1232x430	220x1417x430	220x1232x530	220x1463x530	356x1600x798
Weight (without water content)		kg	15,5	24	28	29	43	63
Sound power global	S-Lo / Med / S-Hi	dB(A)	31/45/53	36/48/57	40/52/58	46/59/63	52/57/66	52/64/71
Static pressure	Max	Pa	50	70	70	70	70	110
Airflow ¹	Med / S-Hi	m ³ /h	388/483	486/716	640/933	989/1064	936/1397	2112/3176
Water pressure drop	Med / S-Hi	kPa	9,9/14,3	13,0/22,4	25,2/42,2	13,9/17,9	22,6/40,3	19,8/26,1
Fan speeds			3 speeds	3 speeds	3 speeds	3 speeds	3 speeds	3 speeds
Fan motor and total speeds			AC 5 speeds	AC 5 speeds	AC 5 speeds	AC 5 speeds	AC 5 speeds	AC 5 speeds
Drain pan			Included	Included	Included	Included	Included	Included
Air filter			Included	Included	Included	Included	Included	Included
Water connections		Inch	1/2	1/2	1/2	1/2 (1/4 cooling)	1/2	1

¹) Airflow at 0Pa of static pressure.

Performances based on: Summer air 27 °C/19 °C (wet Bulb and chilled water 7/12 °C - Winter air 20 °C, entering water temperature 50 °C.



New range of Fan Coil units

Easy to install, improvement in sounds levels and performances, are the key developments carried on our Fan Coil units. The Fan Coil is issued from that development striving to meet customers' wishes and advices.

New Fan Coil range consist on one compact ducted range ideal for residential and commercial use and one model with high static pressure for commercial applications. The range certified by Eurovent includes drain pan and filter and are equipped with a low consumption fan motor. Easy maintenance and access.

1 Innovation for an optimum comfort

New range of Fan Coil for heating and cooling with 6 capacities from 2,4 to 14,80 kW in cooling and from 3,0 to 19,90 kW in heating. It can bring full year comfort together with an Aquarea system or VRF systems.

2 Low energy consumption fan

5 Speed level. The units are fitted with a fan-motor assembly of which the fan is composed of double inlet forward curved centrifugal wheel dynamically balanced and specially designed for an optimal air flow.

3 Quality and efficient Coil

Made of staggered copper tubes, mechanically expanded into aluminium fins, assuring maximum heat transfer efficiency. Equipped with a main chilled water coil with 3 rows.

4 Easy and flexible installation

- Suction G2 air filter from both sides and for the bottom
- Includes drain pan

AQUAREA DHW

AQUAREA
DHW

Aquarea DHW

Model		Floor standing at -7 °C*			Wall mounted		
		PAW-DHWM200A	PAW-DHWM300A	PAW-DHWM300AE	PAW-DHWM80ZNT	PAW-DHWM100ZNT	PAW-DHWM120ZNT
Reference							
Volume	L	208	295	276	80	100	120
Height / with air ducts	mm	1540x670x690	1960x670x690	1960x670x690	1197x506x533	1342x506x533	1497x506x533
Connections to the water supply network		G1	G1	G1	G 1/2	G 1/2	G 1/2
Dimension of air ducts	mm / m	Ø160/—	Ø160/—	Ø160/—	Ø125(150x70)/10	Ø125(150x70)/10	Ø125(150x70)/10
Net weight / with water	kg	149/365	164/459	207/480	58/138	62/162	68/188
Nominal electrical power	W	490	490	490	250	250	250
Reference tapping cycle		L	XL	XL	M	M	M
Energy consumption by chosen cycle A7 / W10-55 ¹	kWh	4,05	5,77	5,96	2,45	2,35	2,51
Energy consumption by chosen cycle A15 / W10-55 ²	kWh	3,95	5,65	5,75	2,04	2,05	2,08
COP DHW (A7 / W10-55) EN 16147 ¹		3,00	3,33	3,30	2,65	2,63	2,61
COP DHW (A15 / W10-55) EN 16147 ²		3,07	3,39	3,38	3,10	3,10	3,10
Energy Efficiency Class (from A+ to F)		A	A	A	A	A	A
Standby Input power according to EN16147	W	28	18	20	19	20	27
Sound power / Sound Pressure on 1m	dB / dB(A)	—/58	—/58	—/58	51,0/39,5	51,0/39,5	51,0/39,5
Refrigerant		R134a	R134a	R134a	R134a	R134a	R134a
Quantity of refrigerant	g	1100	1100	1100	540	540	540
Operating range - air temperature	°C	-7/+35	-7/+35	-7/+35	-7/+35	-7/+35	-7/+35
Nominal air flow rate (Maximum)	m ³ /min	7,5	7,5	7,5	1,7-3,8	1,7-3,8	1,7-3,8
Maximum pressure drop (volumetric flow rate at 5,5m ³ /min (60 %))	Pa	100	100	100	—	—	—
Pressure drop by 2,5m ³ /min (60 %/80 %) (Maximum) ³	Pa	—	—	—	70(90)	70(90)	70(90)
Enamelled steel tank / Protective magnesium anode		+/+	+/+	+/+	+/+	+/+	+/+
Average insulation thickness	mm	—	—	—	40-85	40-85	40-85
External source exchanger (m ² surface / connection)		—	—	2,7/G1	—	—	—
Max. power consumption without heater	W	490	490	490	—	—	—
Max. power consumption with heater	W	2490	2490	2490	2350	2350	2350
Number of electrical heaters x power	W	2x1000	2x1000	2x1000	2x1000	2x1000	2x1000
Voltage / Frequency	V / Hz	230/50	230/50	230/50	230/50	230/50	230/50
Electric protection	A	16	16	16	16	16	16
Moisture protection		IP24	IP24	IP24	IP24	IP24	IP24
Working pressure (Storage tank / Heat Exchanger)	MPa (bar)	0,6(6)/0,9(9)	0,6(6)/0,9(9)	1,0(10)	1,0(10)	1,0(10)	1,0(10)
Heating with heat pump Min / Max	°C	55/65	55/65	55/65	55/—	55/—	55/—
Heating with electrical heater	°C	75	75	75	75	75	75
Refrigerant (R134a) ⁴	kg/TCO ₂ Eq.	1,100/1,573	1,100/1,573	1,100/1,573	0,540/0,772	0,540/0,772	0,540/0,772



1) Heating of sanitary water up to 55 °C with inlet air temperature at 7 °C, humidity at 89 % and inlet water temperature at 10 °C. According to EN16147. 2) Heating of sanitary water up to 55 °C with inlet air temperature at 15 °C, humidity at 74 % and inlet water temperature at 10 °C. According to EN16147. 3) Normal fan speed 60 %, higher fan speed - special setting on 80 %. 4) Aquarea DHW units are hermetically sealed. * When connected as pressurised, use of safety valve is mandatory.

DHW tank with built-in Heat Pump

The Heat Pump is one of the most energy efficient and cost effective methods of water heating. The pump is mounted on the storage tank and draws energy from the ambient air, using that extra energy source to heat the water up to 55 °C.

SANITARY TANKS



**NEW COMBO TANK.
THE BEST OPTION TO
COMBINE WITH
MONO-BLOC UNITS**

New Combo Tank. The best option to combine with Mono-bloc units

This multifunction tank is the best option to combine with the Aquarea Mono-bloc models.



PAW-TG40C1E3STD



PAW-TD20C1E5

NEW Combo Tank

		PAW-TD20B8E3-1
Dimension H x W x D	mm	1770 x 640 x 690
Weight (empty)	kg	150
Volume	L	185
Power supply	V, Phase, Hz	230, 1, 50
Hot water tank		
Volume	L	185
Max working pressure	MPa (bar)	0,8 (8)
Pressure test	MPa (bar)	1,2 (12)
Max working temp	°C	90
Connections	mm	Ø22
Material		S275 JR vitrified
Insulation	Material, t=mm	PUR, 50
Heating coil surface	m ²	2,1
Electrical heater	W	3000
Energy loss at 65°C	kWh/24h	1,3
Buffer tank		
Volume	L	80
Max working pressure	MPa (bar)	0,6 (6)
Pressure test	MPa (bar)	0,9 (9)
Max working temp	°C	100
Connections	mm	Ø22
Material		S235 JR
Insulation	Material, t=mm	PUR 40 mm

ErP data	Hot water tank 185	Buffer tank 80
Energy efficiency class (from A+ to F)	B	B
Standing loss	W	46
Storage volume	L	80

1) EU Regulation 812/2013. 2) Tested pursuant to EN 12897:2006.

Tanks

		Stainless Steel Tank		Enamelled Tank				Enamelled 2 coils Tank (for bivalent Solar + HP)
Model		PAW-TD20C1E5	PAW-TD30C1E5	PAW-TG15C1EZ	PAW-TG20C1E3STD-1	PAW-TG30C1E3STD-1	PAW-TG40C1E3STD-1	PAW-TG30C2E3STD-1
Water volume	L	192	280	150	185	285	396	284
Max. water temperature	°C	75	75	85	95	95	95	95
Dimension	Height	mm	1265	1345	1507	1565	1888	1417
	Diameter	mm	595	595	500	580	680	760
Net weight / filled	kg	53/—	65/—	70/220	97/282	140/425	171/567	134/418
Electric heater	kW	1,5	1,5	2	3	3	3	3
Power supply	V	230	230	230	230	230	230	230
Material inside tank		Stainless steel	Stainless steel	Steel enamelled	Enamelled	Enamelled	Enamelled	Enamelled
Exchange surface	m ²	1,8	1,8	1,4	2,0	2,5	6,1	2,4 (for HP) +1,0 (for solar or boiler)
Energy loss at 65 °C ¹	kWh/24h	0,99	1,13	1,41	1,60	2,10	1,70	1,60
3 Way valve accessory PAW-3WYVLV-SI or CZ-NV1		Optional	Optional	Optional	Optional	Optional	Optional	Optional
20m temperature sensor cable		Yes	Yes	Yes	Yes	Yes	Yes	Yes
Heat up time	Valuation	★★★★	★★★★	—	★★★★	★★★★	★★★★	★★★★
Energy losses	Valuation	★★★★	★★★★	—	★★★★	★★★★	★★★★	★★★★
Energy Efficiency Class (from A+ to F)		◀A	◀A	◀C	◀C	◀C	◀B	◀B
Warranty		2 years	2 years	2 years	2 years	2 years	2 years	2 years
Maintenance required		No	No	Yearly	Yearly	Yearly	Yearly	Yearly

1) Insulated tested under EN12897. * Includes proportional control thermostat.

ACCESSORIES & CONTROL

Optional PCB's for additional functions



CZ-NS2P
PCB for solar connection kit for Mono-bloc systems.



CZ-NS3P
PCB for solar connection kit for Mono-bloc systems 6 kW and 9 kW.

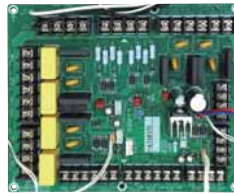

CZ-NS4P
PCB for advanced functions in H Generation.

Accessories for All in One

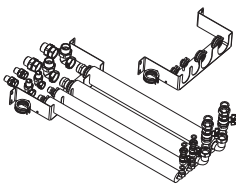

PAW-ADC-PREKIT-H
Flexible pipings and wall mounting plate for All in One H Generation.



PAW-ADC-CV150
Decorative magnetic side cover.

Special outdoor supports



PAW-WTRAY
Tray for condenser water compatible with base ground support.



PAW-GRDSTD40
Outdoor elevation platform.



PAW-GRDBSE20
Outdoor base ground support for noise and vibration absorption (600 x 95 x 130 mm, 500kg).

Hydraulic accessories



PAW-A2W-2ZONEKIT
2 zone kit.



PAW-BTANK50L
Buffer tank 50L



CZ-NV1
3 way valve ready for All in One H Generation (optional in internal space).

PAW-3WYVLV-SI
External 3 way valve.

Deice accessories



CZ-NE1P
Base pan heater (for all old Bi-bloc and Mono-bloc, not for the 3 and 5 kW).

CZ-NE2P
Base pan heater (for 3 kW and 5 kW).

CZ-NE3P
Base pan heater for H Generation.

Accessories for Aquarea Air

PAW-AAIR-LEGS-1
Kits of 2 legs to support the Aquarea Air on the floor and to protect the water pipings.

Accessories for Aquarea DHW

PAW-DHWE2C
2 kW optional electrical heater for floor standing.

PAW-DHWE3C
3 kW optional electrical heater for floor standing.

Sanitary tank accessories



PAW-TS1
Tank sensor with 6m cable length.

PAW-TS2
Tank sensor with 20m cable length.

PAW-TS4
Tank sensor with 6m cable length and only 6mm diameter.



CZ-TK1
Temperature sensor kit for third party tank (with copper pocket and 6m length sensor cable).

Noise reduction for compressor

PAW-2PMP2ZONE
2 zone kit, hydraulic switch, manifold, 2 A-class pumps, 1 mixture valve.

PAW-A2W-2ZONECVR
2 zone kit box cover.

PAW-FILTER
2 check valves + filter with 1" (not compatible with H Generation).

PAW-FILTER-ONLY
Filter with 1" (not compatible with H Generation).

PAW-A2WFILTERFLOW
Filter and water flow meter (not compatible with H Generation).

CZ-UG30
Noise reduction for compressor 2 / 3 dB(A).

Aquarea Manager accessories (not compatible with H Generation)



PAW-HPM1
Aquarea Manager with LCD.



PAW-HPM2
Aquarea Manager without LCD.



PAW-HPMED
Touch screen.



PAW-HPMINT-U
Interface to connect Aquarea Manager to Heat pump Aquarea Bi-bloc (HPM can control all parameters from HP).



PAW-HPMB1
Buffer tank sensor.



PAW-LANCABLE
Network cable.



PAW-HPMAH1
Water flow pipe sensor for heating circuit.



PAW-HPMUH
Outdoor temperature sensor.

PAW-HPMINT-M
Interface to connect Aquarea Manager to Heat pump Aquarea Mono-bloc (HPM can control all parameters from HP).

PAW-HPMDHW
Buffer tank sensor with well.

PAW-HPMSOL1
Buffer tank sensor solar (with higher temperature range).



PAW-A2WSWITCH
Network switch.

PAW-HPMINT-F
Interface to connect Aquarea Manager to Heat pump Aquarea Mono-bloc and Bi-bloc F type (HPM can control all parameters from HP).

PAW-HPMR4
Room sensor + set point adaptation.

PAW-DEWPOINTSSENSOR
Dew point sensor.

Aquarea Manager Kits

PAW-HPM12ZONE-U
HPM with room sensor and setpoint adaption for Bi-bloc + sensors.

PAW-HPM12ZONE-M
HPM with room sensor and setpoint adaption for Mono-bloc + sensors.

PAW-HPM12ZONE-UF
HPM with room sensor and setpoint adaption for F Generation.

PAW-HPM12ZONE-MF
HPM with room sensor and setpoint adaption for F Generation.

PAW-HPM12ZONELCD-U
HPM with LCD wireless room thermostat for Bi-bloc + sensors.

PAW-HPM12ZONELCD-M
HPM with LCD wireless room thermostat for Mono-bloc + sensors.

PAW-HPM12ZONELCD-UF
HPM with LCD wireless room thermostat for F Generation.

PAW-HPM12ZONELCD-M
HPM with LCD wireless room thermostat for F Generation.

Connectivity solutions



CZ-TAW1
Aquarea Smart Cloud for remote control and maintenance through wireless or wired LAN.



PAW-AW-KNX-1i
KNX interface (not compatible with H Generation).



PAW-AW-MBS-1
Modbus interface (not compatible with H Generation).

PA-AW-WIFI-1TE
WLAN interface(not compatible with H Generation).

PAW-AW-KNX-H
KNX interface for H Generation.

PAW-AW-MBS-H
Modbus interface for H Generation.

Controller



PAW-A2W-BIV
Bivalent controller (not compatible with H Generation).

Fan coil Controller



PAW-FC-303TC
Fan coil control.

Room thermostats



PAW-A2W-RTWIRED
Wired LCD room thermostat with weekly timer.



PAW-A2W-RTWIRELESS
Wireless LCD room thermostat with weekly timer.

H Generation sensors



PAW-A2W-TSOD
Outdoor ambient sensor.



PAW-A2W-TSRT
Zone room sensor.



PAW-A2W-TSHC
Zone water sensor.



PAW-A2W-TSSO
Solar sensor.

PAW-A2W-TSBU
Buffer tank sensor.

HEATING & COOLING CAPACITY TABLES. Based on outlet temperature and outside temperature.

Aquarea H Generation High Performance Bi-bloc Single Phase. Heating and Cooling

WH-UD03HE5-1																		
Tamb	HC	IP	COP	HC	IP	COP	HC	IP	COP	HC	IP	COP	HC	IP	COP	HC	IP	COP
LWC	30	30	30	35	35	35	40	40	40	45	45	45	50	50	50	55	55	55
-15	3,20	1,26	2,54	3,20	1,39	2,30	3,10	1,52	2,04	3,00	1,64	1,83	2,80	1,78	1,57	2,75	1,92	1,43
-7	3,20	1,08	2,96	3,20	1,19	2,69	3,20	1,34	2,39	3,20	1,48	2,16	3,20	1,67	1,92	3,20	1,86	1,72
2	3,20	0,82	3,90	3,20	0,90	3,56	3,20	1,03	3,11	3,20	1,16	2,76	3,20	1,33	2,41	3,20	1,49	2,15
7	3,20	0,58	5,52	3,20	0,64	5,00	3,20	0,77	4,16	3,20	0,89	3,60	3,20	1,05	3,05	3,20	1,20	2,67
16	3,20	0,50	6,40	3,20	0,55	5,82	3,20	0,64	5,00	3,20	0,72	4,44	3,20	0,86	3,72	3,20	0,99	3,23
25	3,20	0,42	7,62	3,20	0,46	6,96	3,20	0,55	5,82	3,20	0,63	5,08	3,20	0,73	4,38	3,20	0,82	3,90
WH-UD05HE5-1																		
Tamb	HC	IP	COP	HC	IP	COP	HC	IP	COP	HC	IP	COP	HC	IP	COP	HC	IP	COP
LWC	30	30	30	35	35	35	40	40	40	45	45	45	50	50	50	55	55	55
-15	4,20	1,75	2,40	4,20	1,94	2,16	3,80	1,96	1,94	3,40	1,98	1,72	3,20	2,05	1,56	3,00	2,12	1,42
-7	4,20	1,46	2,88	4,20	1,62	2,59	4,00	1,72	2,33	3,80	1,82	2,09	3,70	1,95	1,90	3,55	2,08	1,71
2	4,20	1,22	3,44	4,20	1,35	3,11	4,20	1,50	2,80	4,20	1,65	2,55	4,15	1,86	2,23	4,10	2,07	1,98
7	5,00	0,97	5,15	5,00	1,08	4,63	5,00	1,28	3,91	5,00	1,48	3,38	5,00	1,68	2,98	5,00	1,89	2,65
16	5,00	0,83	6,02	5,00	0,92	5,43	5,00	1,15	4,35	5,00	1,38	3,62	5,00	1,53	3,27	5,00	1,68	2,98
25	5,00	0,74	6,76	5,00	0,82	6,10	5,00	1,02	4,90	5,00	1,22	4,10	5,00	1,35	3,70	5,00	1,49	3,36
WH-UD07HE5-1																		
Tamb	HC	IP	COP	HC	IP	COP	HC	IP	COP	HC	IP	COP	HC	IP	COP	HC	IP	COP
LWC	30	30	30	35	35	35	40	40	40	45	45	45	50	50	50	55	55	55
-15	—	—	—	4,60	1,98	2,32	4,60	2,19	2,10	4,60	2,40	1,92	4,55	2,63	1,73	4,50	2,86	1,57
-7	—	—	—	5,15	1,92	2,68	5,08	2,14	2,37	5,00	2,36	2,12	4,90	2,45	2,00	4,80	2,54	1,89
2	—	—	—	6,55	1,96	3,34	6,58	2,29	2,87	6,60	2,62	2,52	6,30	2,82	2,23	6,00	3,01	1,99
7	—	—	—	7,00	1,57	4,46	7,00	1,84	3,80	7,00	2,10	3,33	6,90	2,35	2,94	6,80	2,59	2,63
25	—	—	—	7,00	0,97	7,22	6,74	1,14	5,91	6,48	1,31	4,95	6,24	1,43	4,36	6,00	1,55	3,87
WH-UD09HE5-1																		
Tamb	HC	IP	COP	HC	IP	COP	HC	IP	COP	HC	IP	COP	HC	IP	COP	HC	IP	COP
LWC	30	30	30	35	35	35	40	40	40	45	45	45	50	50	50	55	55	55
-15	—	—	—	5,90	2,66	2,22	5,65	2,82	2,00	5,40	2,98	1,81	5,20	3,08	1,69	5,00	3,18	1,57
-7	—	—	—	5,90	2,34	2,52	5,85	2,61	2,24	5,80	2,88	2,01	5,80	2,98	1,95	5,80	3,08	1,88
2	—	—	—	6,70	2,14	3,13	6,65	2,38	2,79	6,60	2,62	2,52	6,30	2,82	2,23	6,00	3,01	1,99
7	—	—	—	9,00	2,18	4,13	9,00	2,49	3,61	9,00	2,79	3,23	8,95	3,25	2,75	8,90	3,70	2,41
25	—	—	—	9,00	1,26	7,14	8,66	1,48	5,85	8,32	1,69	4,92	8,03	1,85	4,34	7,74	2,01	3,85

Aquarea H Generation High Performance Bi-bloc Single Phase. Heating and Cooling

WH-UD03HE5-1									
Tamb	CC	IP	EER	CC	IP	EER	CC	IP	EER
LWC	7	7	7	14	14	14	18	18	18
18	2,40	0,42	5,71	4,40	0,73	6,03	3,70	0,49	7,55
25	3,20	0,73	4,38	4,10	0,86	4,77	3,50	0,59	5,93
35	3,20	1,04	3,08	3,90	1,07	3,64	3,30	0,74	4,46
43	2,90	1,20	2,42	3,50	1,20	2,92	3,00	0,88	3,41
WH-UD05HE5-1									
Tamb	CC	IP	EER	CC	IP	EER	CC	IP	EER
LWC	7	7	7	14	14	14	18	18	18
18	4,50	0,89	5,06	5,00	0,90	5,56	5,70	0,90	6,33
25	5,00	1,43	3,50	6,30	1,50	4,20	5,40	1,06	5,09
35	4,50	1,67	2,69	5,50	1,68	3,27	5,00	1,33	3,76
43	3,30	1,53	2,16	4,10	1,52	2,70	4,40	1,53	2,88
WH-UD07HE5-1									
Tamb	CC	IP	EER	CC	IP	EER	CC	IP	EER
LWC	7	7	7	14	14	14	18	18	18
18	4,80	0,80	6,00	7,20	1,16	6,21	6,00	1,13	5,31
25	7,00	1,90	3,68	8,47	1,78	4,76	6,00	1,27	4,72
35	6,00	2,28	2,63	6,60	2,48	2,66	6,00	1,68	3,57
43	4,85	2,65	1,83	6,00	2,82	2,13	4,80	1,98	2,42
WH-UD09HE5-1									
Tamb	CC	IP	EER	CC	IP	EER	CC	IP	EER
LWC	7	7	7	14	14	14	18	18	18
18	5,40	1,00	5,40	8,40	1,62	5,19	7,00	1,61	4,35
25	7,85	2,40	3,27	10,20	2,46	4,15	7,00	1,77	3,95
35	7,00	2,88	2,43	7,60	3,20	2,38	7,00	2,15	3,26
43	5,20	2,85	1,82	6,99	3,84	1,82	5,60	2,55	2,20

Aquarea H Generation High Performance Bi-bloc Three Phase. Heating and Cooling

WH-UD09HE8

Tamb	HC	IP	COP	HC	IP	COP	HC	IP	COP	HC	IP	COP	HC	IP	COP	HC	IP	COP
LWC	30	30	30	35	35	35	40	40	40	45	45	45	50	50	50	55	55	55
-15	8,65	3,06	2,83	8,30	3,21	2,59	7,95	3,41	2,33	7,60	3,61	2,11	7,15	3,71	1,93	6,70	3,81	1,76
-7	9,35	2,91	3,21	9,00	3,16	2,85	8,85	3,54	2,50	8,70	3,92	2,22	8,30	3,89	2,13	7,90	3,86	2,05
2	9,31	2,35	3,96	9,00	2,51	3,59	9,00	2,78	3,24	9,00	3,05	2,95	8,90	3,49	2,55	8,80	3,94	2,23
7	9,00	1,54	5,84	9,00	1,86	4,84	9,00	2,16	4,17	9,00	2,46	3,66	9,00	2,76	3,26	9,00	3,06	2,94
25	9,00	1,05	8,57	9,00	1,24	7,26	8,73	1,44	6,06	8,46	1,64	5,16	8,28	1,82	4,55	8,10	2,00	4,05

WH-UD12HE8

Tamb	HC	IP	COP	HC	IP	COP	HC	IP	COP	HC	IP	COP	HC	IP	COP	HC	IP	COP
LWC	30	30	30	35	35	35	40	40	40	45	45	45	50	50	50	55	55	55
-15	9,30	3,46	2,69	8,90	3,62	2,46	8,50	3,79	2,24	8,10	3,95	2,05	7,50	4,05	1,85	7,00	4,16	1,68
-7	10,40	3,37	3,09	10,00	3,66	2,73	9,60	3,95	2,43	9,20	4,24	2,17	8,70	4,26	2,04	8,20	4,27	1,92
2	11,80	3,10	3,81	11,40	3,31	3,44	11,00	3,53	3,12	10,60	3,74	2,83	9,80	3,94	2,49	9,10	4,14	2,20
7	12,00	2,10	5,71	12,00	2,53	4,74	12,00	2,96	4,05	12,00	3,39	3,54	12,00	3,78	3,17	12,00	4,16	2,88
25	12,00	1,38	8,70	12,00	1,66	7,23	11,80	1,94	6,08	11,70	2,23	5,25	11,50	2,49	4,62	11,40	2,74	4,16

WH-UD16HE8

Tamb	HC	IP	COP	HC	IP	COP	HC	IP	COP	HC	IP	COP	HC	IP	COP	HC	IP	COP
LWC	30	30	30	35	35	35	40	40	40	45	45	45	50	50	50	55	55	55
-15	10,60	4,09	2,59	10,30	4,38	2,35	10,00	4,67	2,14	9,70	4,96	1,96	8,80	4,94	1,78	7,90	4,91	1,61
-7	11,90	4,03	2,95	11,40	4,43	2,57	10,80	4,83	2,24	10,30	5,22	1,97	9,60	5,09	1,89	9,00	4,95	1,82
2	13,50	3,74	3,61	13,00	3,96	3,28	12,40	4,18	2,97	11,90	4,40	2,70	10,80	4,46	2,42	9,80	4,51	2,17
7	16,00	3,21	4,98	16,00	3,74	4,28	16,00	4,27	3,75	16,00	4,80	3,33	15,20	5,11	2,97	14,50	5,41	2,68
25	16,00	2,31	6,93	16,00	2,69	5,95	16,00	3,07	5,21	16,00	3,45	4,64	16,00	3,67	4,36	15,90	3,89	4,09

Aquarea H Generation High Performance Bi-bloc Three Phase. Heating and Cooling

WH-UD09HE8

Tamb	CC	IP	EER	CC	IP	EER	CC	IP	EER
LWC	7	7	7	14	14	14	18	18	18
16	7,50	1,15	6,52	9,10	1,20	7,58	7,00	1,13	6,19
25	8,35	1,77	4,72	10,90	1,78	6,12	7,00	1,24	5,65
35	7,00	2,23	3,14	8,30	2,32	3,58	7,00	1,52	4,61
43	5,52	2,54	2,17	7,69	2,77	2,78	5,60	1,80	3,11

WH-UD12HE8

Tamb	CC	IP	EER	CC	IP	EER	CC	IP	EER
LWC	7	7	7	14	14	14	18	18	18
16	7,86	1,18	6,66	13,15	1,40	9,39	10,00	1,73	5,78
25	12,08	2,90	4,17	15,70	2,05	7,66	10,00	1,97	5,08
35	10,00	2,56	3,91	12,00	2,67	4,49	10,00	2,40	4,17
43	7,80	3,80	2,05	11,10	3,19	3,48	8,00	2,85	2,81

WH-UD16HE8

Tamb	CC	IP	EER	CC	IP	EER	CC	IP	EER
LWC	7	7	7	14	14	14	18	18	18
16	9,20	1,62	5,68	16,40	2,58	6,36	12,20	2,45	4,98
25	14,40	3,92	3,67	19,20	3,83	5,01	12,20	2,79	4,37
35	12,20	4,76	2,56	15,00	4,98	3,01	12,20	2,96	4,12
43	7,75	3,40	2,28	13,80	5,95	2,32	9,70	4,00	2,43

HEATING & COOLING CAPACITY TABLES. Based on outlet temperature and outside temperature.

Aquarea H Generation T-CAP Bi-bloc Single Phase / Three Phase. Heating and Cooling

WH-UX09HE5																		
Tamb	HC	IP	COP	HC	IP	COP	HC	IP	COP	HC	IP	COP	HC	IP	COP	HC	IP	COP
LWC	30	30	30	35	35	35	40	40	40	45	45	45	50	50	50	55	55	55
-15	9,00	3,24	2,78	9,00	3,51	2,56	9,00	3,91	2,30	9,00	4,30	2,09	9,00	4,73	1,90	9,00	5,16	1,74
-7	9,00	2,71	3,32	9,00	3,16	2,85	9,00	3,62	2,49	9,00	4,07	2,21	9,00	4,27	2,11	9,00	4,46	2,02
2	9,00	2,36	3,81	9,00	2,51	3,59	9,00	2,78	3,24	9,00	3,05	2,95	9,00	3,56	2,53	9,00	4,07	2,21
7	9,00	1,64	5,49	9,00	1,86	4,84	9,00	2,16	4,17	9,00	2,46	3,66	9,00	2,76	3,26	9,00	3,06	2,94
25	13,60	1,50	9,07	13,60	1,71	7,95	13,20	1,93	6,84	12,80	2,14	5,98	12,00	2,41	4,98	11,20	2,67	4,19
WH-UX12HE5																		
Tamb	HC	IP	COP	HC	IP	COP	HC	IP	COP	HC	IP	COP	HC	IP	COP	HC	IP	COP
LWC	30	30	30	35	35	35	40	40	40	45	45	45	50	50	50	55	55	55
-15	12,00	4,75	2,53	12,00	4,96	2,42	12,00	5,41	2,22	11,00	5,38	2,04	10,80	5,82	1,86	10,50	6,26	1,68
-7	12,00	3,85	3,12	12,00	4,41	2,72	12,00	4,98	2,41	12,00	5,54	2,17	12,00	5,90	2,03	12,00	6,26	1,92
2	12,00	3,19	3,76	12,00	3,49	3,44	12,00	3,87	3,10	12,00	4,25	2,82	12,00	4,86	2,47	12,00	5,47	2,19
7	12,00	2,18	5,50	12,00	2,53	4,74	12,00	2,96	4,05	12,00	3,39	3,54	12,00	3,78	3,17	12,00	4,16	2,88
25	13,60	1,55	8,77	13,60	1,76	7,73	13,40	2,10	6,38	13,20	2,43	5,43	12,60	2,66	4,74	12,00	2,89	4,15
WH-UX09HE8																		
Tamb	HC	IP	COP	HC	IP	COP	HC	IP	COP	HC	IP	COP	HC	IP	COP	HC	IP	COP
LWC	30	30	30	35	35	35	40	40	40	45	45	45	50	50	50	55	55	55
-15	9,00	3,24	2,78	9,00	3,51	2,56	9,00	3,91	2,30	9,00	4,30	2,09	9,00	4,73	1,90	9,00	5,16	1,74
-7	9,00	2,71	3,32	9,00	3,16	2,85	9,00	3,62	2,49	9,00	4,07	2,21	9,00	4,27	2,11	9,00	4,46	2,02
2	9,00	2,36	3,81	9,00	2,51	3,59	9,00	2,78	3,24	9,00	3,05	2,95	9,00	3,56	2,53	9,00	4,07	2,21
7	9,00	1,64	5,49	9,00	1,86	4,84	9,00	2,16	4,17	9,00	2,46	3,66	9,00	2,76	3,26	9,00	3,06	2,94
25	13,60	1,50	9,07	13,60	1,71	7,95	13,20	1,93	6,84	12,80	2,14	5,98	12,00	2,41	4,98	11,20	2,67	4,19
WH-UX12HE8																		
Tamb	HC	IP	COP	HC	IP	COP	HC	IP	COP	HC	IP	COP	HC	IP	COP	HC	IP	COP
LWC	30	30	30	35	35	35	40	40	40	45	45	45	50	50	50	55	55	55
-15	12,00	4,75	2,53	12,00	4,96	2,42	12,00	5,41	2,22	12,00	5,86	2,05	11,80	6,24	1,89	11,60	6,62	1,75
-7	12,00	3,85	3,12	12,00	4,41	2,72	12,00	4,98	2,41	12,00	5,54	2,17	12,00	5,90	2,03	12,00	6,26	1,92
2	12,00	3,19	3,76	12,00	3,49	3,44	12,00	3,87	3,10	12,00	4,25	2,82	12,00	4,86	2,47	12,00	5,47	2,19
7	12,00	2,18	5,50	12,00	2,53	4,74	12,00	2,96	4,05	12,00	3,39	3,54	12,00	3,78	3,17	12,00	4,16	2,88
25	13,60	1,55	8,77	13,60	1,76	7,73	13,40	2,10	6,38	13,20	2,43	5,43	12,60	2,66	4,74	12,00	2,89	4,15
WH-UX16HE8																		
Tamb	HC	IP	COP	HC	IP	COP	HC	IP	COP	HC	IP	COP	HC	IP	COP	HC	IP	COP
LWC	30	30	30	35	35	35	40	40	40	45	45	45	50	50	50	55	55	55
-15	16,00	6,30	2,54	16,00	6,89	2,32	16,00	7,45	2,15	16,00	8,10	1,98	16,00	8,48	1,89	15,20	8,96	1,70
-7	16,00	5,85	2,74	16,00	6,42	2,49	16,00	7,00	2,29	16,00	7,57	2,11	16,00	8,10	1,98	16,00	8,62	1,86
2	16,00	4,67	3,43	16,00	5,21	3,07	16,00	5,74	2,79	16,00	6,31	2,54	16,00	6,90	2,32	16,00	7,50	2,13
7	16,00	3,35	4,78	16,00	3,74	4,28	16,00	4,30	3,72	16,00	4,80	3,33	16,00	5,43	2,95	16,00	5,91	2,71
16	16,00	2,59	6,18	16,00	3,18	5,03	16,00	3,71	4,31	16,00	4,27	3,75	16,00	4,86	3,29	16,00	5,22	3,07
25	16,00	2,02	7,92	16,00	2,58	6,20	16,00	2,91	5,50	16,00	3,36	4,76	16,00	3,74	4,28	16,00	4,00	4,00

Aquarea H Generation T-CAP Bi-bloc Single Phase / Three Phase. Heating and Cooling

Models																		
Tamb	WH-UX09HE5									WH-UX12HE5								
	CC	IP	EER	CC	IP	EER	CC	IP	EER	CC	IP	EER	CC	IP	EER	CC	IP	EER
LWC	7	7	7	14	14	14	18	18	18	7	7	7	14	14	14	18	18	18
18	7,00	1,36	5,15	8,55	1,41	6,06	7,00	1,00	7,00	10,00	1,75	5,71	13,20	1,96	6,73	10,00	1,40	7,14
25	7,65	1,91	4,01	11,10	1,98	5,61	7,00	1,10	6,36	11,20	2,67	4,19	16,50	3,01	5,48	10,00	1,60	6,25
35	7,00	2,21	3,17	9,23	2,37	3,89	7,00	1,35	5,19	10,00	3,56	2,81	12,55	3,63	3,46	10,00	1,95	5,13
43	6,25	2,66	2,35	8,55	2,71	3,15	5,60	1,60	3,50	8,00	3,35	2,39	10,00	3,46	2,89	8,00	2,30	3,48
Models																		
Tamb	WH-UX09HE8						WH-UX12HE8						WH-UX16HE8					
	CC	IP	EER	CC	IP	EER	CC	IP	EER	CC	IP	EER	CC	IP	EER	CC	IP	EER
LWC	7	7	7	18	18	18	7	7	7	18	18	18	7	7	7	18	18	18
18	7,00	1,36	5,15	—	—	—	7,50	1,41	5,32	—	—	—	8,50	1,70	5,00	10,00	1,70	5,88
25	7,65	1,91	4,01	—	—	—	8,90	2,16	4,12	—	—	—	14,00	4,00	3,50	14,00	2,94	4,76
35	7,00	2,21	3,17	—	—	—	10,00	3,56	2,81	—	—	—	12,20	4,76	2,56	12,20	3,50	3,49
43	6,25	2,66	2,35	—	—	—	8,00	3,01	2,66	—	—	—	7,10	3,31	2,15	9,80	3,31	2,96

Aquarea H Generation T-CAP Bi-bloc Three Phase. Super Quiet outdoor unit. Heating and Cooling - SQC

WH-UQ09HE8

Tamb	HC	IP	COP	HC	IP	COP	HC	IP	COP	HC	IP	COP	HC	IP	COP	HC	IP	COP
LWC	30	30	30	35	35	35	40	40	40	45	45	45	50	50	50	55	55	55
-15	9,00	3,24	2,78	9,00	3,51	2,56	9,00	3,91	2,30	9,00	4,30	2,09	9,00	4,73	1,90	9,00	5,16	1,74
-7	9,00	2,71	3,32	9,00	3,16	2,85	9,00	3,62	2,49	9,00	4,07	2,21	9,00	4,27	2,11	9,00	4,46	2,02
2	9,00	2,36	3,81	9,00	2,51	3,59	9,00	2,78	3,24	9,00	3,05	2,95	9,00	3,56	2,53	9,00	4,07	2,21
7	9,00	1,64	5,49	9,00	1,86	4,84	9,00	2,16	4,17	9,00	2,46	3,66	9,00	2,76	3,26	9,00	3,06	2,94
25	13,60	1,50	9,07	13,60	1,71	7,95	13,20	1,93	6,84	12,80	2,14	5,98	12,00	2,41	4,98	11,20	2,67	4,19

WH-UQ12HE8

Tamb	HC	IP	COP	HC	IP	COP	HC	IP	COP	HC	IP	COP	HC	IP	COP	HC	IP	COP
LWC	30	30	30	35	35	35	40	40	40	45	45	45	50	50	50	55	55	55
-15	12,00	4,75	2,53	12,00	4,96	2,42	12,00	5,41	2,22	12,00	5,86	2,05	11,80	6,24	1,89	11,60	6,62	1,75
-7	12,00	3,85	3,12	12,00	4,41	2,72	12,00	4,98	2,41	12,00	5,54	2,17	12,00	5,90	2,03	12,00	6,26	1,92
2	12,00	3,19	3,76	12,00	3,49	3,44	12,00	3,87	3,10	12,00	4,25	2,82	12,00	4,86	2,47	12,00	5,47	2,19
7	12,00	2,18	5,50	12,00	2,53	4,74	12,00	2,96	4,05	12,00	3,39	3,54	12,00	3,78	3,17	12,00	4,16	2,88
25	13,60	1,55	8,77	13,60	1,76	7,73	13,40	2,10	6,38	13,20	2,43	5,43	12,60	2,66	4,74	12,00	2,89	4,15

WH-UQ16HE8

Tamb	HC	IP	COP	HC	IP	COP	HC	IP	COP	HC	IP	COP	HC	IP	COP	HC	IP	COP
LWC	30	30	30	35	35	35	40	40	40	45	45	45	50	50	50	55	55	55
-15	16,00	6,30	2,54	16,00	6,89	2,32	16,00	7,45	2,15	16,00	8,10	1,98	16,00	8,48	1,89	15,20	8,96	1,70
-7	16,00	5,85	2,74	16,00	6,42	2,49	16,00	7,00	2,29	16,00	7,57	2,11	16,00	8,10	1,98	16,00	8,62	1,86
2	16,00	4,67	3,43	16,00	5,21	3,07	16,00	5,74	2,79	16,00	6,31	2,54	16,00	6,90	2,32	16,00	7,50	2,13
7	16,00	3,35	4,78	16,00	3,74	4,28	16,00	4,30	3,72	16,00	4,80	3,33	16,00	5,43	2,95	16,00	5,91	2,71
16	16,00	2,59	6,18	16,00	3,18	5,03	16,00	3,71	4,31	16,00	4,27	3,75	16,00	4,86	3,29	16,00	5,22	3,07
25	16,00	2,02	7,92	16,00	2,58	6,20	16,00	2,91	5,50	16,00	3,36	4,76	16,00	3,74	4,28	16,00	4,00	4,00

Aquarea H Generation T-CAP Bi-bloc Three Phase. Super Quiet outdoor unit. Heating and Cooling - SQC

WH-UQ09HE8

Tamb	CC	IP	EER	CC	IP	EER
LWC	7	7	7	18	18	18
18	7,00	1,36	5,15	—	—	—
25	7,65	1,91	4,01	—	—	—
35	7,00	2,21	3,17	—	—	—
43	6,25	2,66	2,35	—	—	—

WH-UQ12HE8

Tamb	CC	IP	EER	CC	IP	EER
LWC	7	7	7	18	18	18
18	7,50	1,41	5,32	—	—	—
25	8,90	2,16	4,12	—	—	—
35	10,00	3,56	2,81	—	—	—
43	8,00	3,01	2,66	—	—	—

WH-UQ16HE8

Tamb	CC	IP	EER	CC	IP	EER
LWC	7	7	7	18	18	18
18	8,50	1,70	5,00	10,00	1,70	5,88
25	14,00	4,00	3,50	14,00	2,94	4,76
35	12,20	4,76	2,56	12,20	3,50	3,49
43	7,10	3,31	2,15	9,80	3,31	2,96

HEATING & COOLING CAPACITY TABLES. Based on outlet temperature and outside temperature.

Aquarea H Generation High Performance Mono-bloc Single Phase. Heating and Cooling - MDC

WH-MDC05H3E5																		
Tamb	HC	IP	COP	HC	IP	COP	HC	IP	COP	HC	IP	COP	HC	IP	COP	HC	IP	COP
LWC	30	30	30	35	35	35	40	40	40	45	45	45	50	50	50	55	55	55
-15	5,13	2,02	2,54	5,00	2,20	2,27	4,88	2,39	2,04	4,75	2,57	1,85	4,08	2,29	1,78	3,40	2,00	1,70
-7	4,80	1,49	3,23	4,70	1,65	2,85	4,60	1,82	2,53	4,50	1,98	2,27	4,40	2,13	2,07	4,30	2,28	1,89
2	5,10	1,34	3,81	4,80	1,43	3,36	4,50	1,52	2,96	4,20	1,61	2,61	4,10	1,67	2,46	4,00	1,72	2,33
7	5,00	0,79	6,33	5,00	0,99	5,08	5,00	1,18	4,24	5,00	1,37	3,65	5,00	1,57	3,19	5,00	1,76	2,84
12	4,85	0,77	6,29	4,83	0,89	5,46	4,82	1,00	4,82	4,80	1,12	4,29	4,74	1,25	3,81	4,68	1,37	3,42
WH-MDC07H3E5																		
Tamb	HC	IP	COP	HC	IP	COP	HC	IP	COP	HC	IP	COP	HC	IP	COP	HC	IP	COP
LWC	30	30	30	35	35	35	40	40	40	45	45	45	50	50	50	55	55	55
-15	4,60	1,68	2,75	4,60	1,89	2,43	4,60	2,11	2,19	4,60	2,32	1,98	4,55	2,56	1,78	4,50	2,79	1,61
-7	5,60	1,88	2,99	5,50	2,04	2,70	5,40	2,21	2,45	5,30	2,37	2,24	5,15	2,56	2,01	5,00	2,75	1,82
2	6,65	1,79	3,73	6,60	2,00	3,30	6,55	2,22	2,96	6,50	2,43	2,67	6,40	2,64	2,43	6,30	2,84	2,22
7	7,00	1,33	5,28	7,00	1,55	4,52	7,00	1,78	3,94	7,00	2,00	3,50	7,00	2,24	3,13	7,00	2,47	2,83
12	7,00	1,30	5,38	7,00	1,45	4,83	7,05	1,65	4,27	7,10	1,90	3,74	7,15	2,10	3,40	7,20	2,30	3,13
WH-MDC09H3E5																		
Tamb	HC	IP	COP	HC	IP	COP	HC	IP	COP	HC	IP	COP	HC	IP	COP	HC	IP	COP
LWC	30	30	30	35	35	35	40	40	40	45	45	45	50	50	50	55	55	55
-15	6,10	2,34	2,61	5,90	2,50	2,36	5,70	2,67	2,14	5,50	2,83	1,94	5,25	2,99	1,76	5,00	3,14	1,59
-7	6,55	2,26	2,90	6,40	2,46	2,60	6,25	2,66	2,35	6,10	2,86	2,13	5,95	3,06	1,95	5,80	3,25	1,78
2	6,85	1,92	3,58	6,80	2,14	3,18	6,75	2,37	2,85	6,70	2,59	2,59	6,50	2,78	2,34	6,30	2,96	2,13
7	9,00	1,80	5,01	9,00	2,10	4,29	9,00	2,41	3,74	9,00	2,71	3,32	9,00	3,01	2,99	9,00	3,31	2,72
12	9,10	1,61	5,65	9,00	1,79	5,03	9,00	2,09	4,31	9,10	2,40	3,79	9,20	2,80	3,29	9,30	3,00	3,10
WH-MDC12H6E5																		
Tamb	HC	IP	COP	HC	IP	COP	HC	IP	COP	HC	IP	COP	HC	IP	COP	HC	IP	COP
LWC	30	30	30	35	35	35	40	40	40	45	45	45	50	50	50	55	55	55
-15	9,30	3,46	2,69	8,90	3,62	2,46	8,50	3,79	2,24	8,10	3,95	2,05	—	—	—	7,00	4,10	1,71
-7	10,40	3,37	3,09	10,00	3,66	2,73	9,60	3,95	2,43	9,20	4,24	2,17	—	—	—	8,20	4,21	1,95
2	11,80	3,10	3,81	11,40	3,31	3,44	11,00	3,53	3,12	10,60	3,74	2,83	—	—	—	9,10	4,08	2,23
7	12,00	2,10	5,71	12,00	2,53	4,74	12,00	2,96	4,05	12,00	3,39	3,54	—	—	—	12,00	4,10	2,93
12	12,00	1,38	8,70	12,00	1,66	7,23	11,80	1,94	6,08	11,70	2,23	5,25	—	—	—	11,40	2,74	4,16
WH-MDC16H6E5																		
Tamb	HC	IP	COP	HC	IP	COP	HC	IP	COP	HC	IP	COP	HC	IP	COP	HC	IP	COP
LWC	30	30	30	35	35	35	40	40	40	45	45	45	50	50	50	55	55	55
-15	10,60	4,09	2,59	10,30	4,38	2,35	10,00	4,67	2,14	9,70	4,96	1,96	7,90	4,84	1,63	—	—	—
-7	11,90	4,03	2,95	11,40	4,43	2,57	10,80	4,83	2,24	10,30	5,22	1,97	9,00	4,88	1,84	—	—	—
2	13,50	3,74	3,81	13,00	3,96	3,28	12,40	4,18	2,97	11,90	4,40	2,70	9,80	4,44	2,21	—	—	—
7	16,00	3,21	4,98	16,00	3,74	4,28	16,00	4,27	3,75	16,00	4,80	3,33	14,50	5,33	2,72	—	—	—
12	16,00	2,31	6,93	16,00	2,69	5,95	16,00	3,07	5,21	16,00	3,45	4,64	15,90	3,89	4,09	—	—	—

Aquarea H Generation High Performance Mono-bloc Single Phase. Heating and Cooling - MDC

WH-MDC05H3E5										WH-MDC07H3E5								
Tamb	CC	IP	EER	CC	IP	EER	CC	IP	EER	CC	IP	EER	CC	IP	EER	CC	IP	EER
LWC	7	7	7	14	14	14	18	18	18	7	7	7	14	14	14	18	18	18
24	5,15	1,06	4,86	6,45	1,05	6,14	5,90	0,73	8,08	6,85	1,78	3,85	8,15	1,80	4,53	7,10	1,20	5,92
35	4,50	1,37	3,28	5,52	1,36	4,06	5,10	1,00	5,10	6,00	2,16	2,78	5,35	1,53	3,51	6,00	1,55	3,87
43	3,74	1,55	2,41	4,65	1,60	2,91	4,25	1,20	3,54	4,90	2,48	1,98	4,45	1,80	2,47	5,10	1,85	2,76
WH-MDC09H3E5										WH-MDC12H6E5								
Tamb	CC	IP	EER	CC	IP	EER	CC	IP	EER	CC	IP	EER	CC	IP	EER	CC	IP	EER
LWC	7	7	7	14	14	14	18	18	18	7	7	7	14	14	14	18	18	18
16	—	—	—	—	—	—	—	—	—	7,86	1,18	6,66	13,15	2,05	6,41	10,00	1,73	5,78
24	7,30	1,92	3,80	8,60	1,98	4,34	8,20	1,55	5,29	12,08	2,90	4,17	15,70	3,05	5,15	10,00	1,97	5,08
35	7,00	2,69	2,60	6,40	1,93	3,32	7,00	1,95	3,59	10,00	3,56	2,81	12,00	3,67	3,27	10,00	2,15	4,65
43	5,25	2,84	1,85	5,40	2,25	2,40	6,00	2,30	2,61	7,80	3,80	2,05	11,10	3,19	3,48	8,00	2,85	2,81
WH-MDC16H6E5																		
Tamb	CC	IP	EER	CC	IP	EER	CC	IP	EER									
LWC	7	7	7	14	14	14	18	18	18									
16	9,20	1,62	5,68	16,40	2,58	6,36	12,20	2,45	4,98									
25	14,40	3,92	3,67	19,20	3,83	5,01	12,20	2,79	4,37									
35	12,20	4,76	2,56	15,00	4,98	3,01	12,20	2,96	4,12									
43	7,75	3,40	2,28	13,80	5,95	2,32	9,70	4,00	2,43									

Aquarea H Generation T-CAP Mono-bloc Three Phase. Heating and Cooling - MXC

WH-MXC09H3E8																		
Tamb	HC	IP	COP	HC	IP	COP	HC	IP	COP	HC	IP	COP	HC	IP	COP	HC	IP	COP
LWC	30	30	30	35	35	35	40	40	40	45	45	45	50	50	50	55	55	55
-15	9,00	3,24	2,78	9,00	3,51	2,56	9,00	3,91	2,30	9,00	4,30	2,09	9,00	4,73	1,90	9,00	5,16	1,74
-7	9,00	2,71	3,32	9,00	3,16	2,85	9,00	3,62	2,49	9,00	4,07	2,21	9,00	4,27	2,11	9,00	4,46	2,02
2	9,00	2,36	3,81	9,00	2,51	3,59	9,00	2,78	3,24	9,00	3,05	2,95	9,00	3,56	2,53	9,00	4,07	2,21
7	9,00	1,64	5,49	9,00	1,86	4,84	9,00	2,16	4,17	9,00	2,46	3,66	9,00	2,76	3,26	9,00	3,06	2,94
25	13,60	1,50	9,07	13,60	1,71	7,95	13,20	1,93	6,84	12,80	2,14	5,98	12,00	2,41	4,98	11,20	2,67	4,19
WH-MXC12H9E8																		
Tamb	HC	IP	COP	HC	IP	COP	HC	IP	COP	HC	IP	COP	HC	IP	COP	HC	IP	COP
LWC	30	30	30	35	35	35	40	40	40	45	45	45	50	50	50	55	55	55
-15	12,00	4,75	2,53	12,00	4,96	2,42	12,00	5,41	2,22	12,00	5,86	2,05	11,80	6,24	1,89	11,60	6,62	1,75
-7	12,00	3,85	3,12	12,00	4,41	2,72	12,00	4,98	2,41	12,00	5,54	2,17	12,00	5,90	2,03	12,00	6,26	1,92
2	12,00	3,19	3,76	12,00	3,49	3,44	12,00	3,87	3,10	12,00	4,25	2,82	12,00	4,86	2,47	12,00	5,47	2,19
7	12,00	2,18	5,50	12,00	2,53	4,74	12,00	2,96	4,05	12,00	3,39	3,54	12,00	3,78	3,17	12,00	4,16	2,88
25	13,60	1,55	8,77	13,60	1,76	7,73	13,40	2,10	6,38	13,20	2,43	5,43	12,60	2,66	4,74	12,00	2,89	4,15
WH-MXC16H9E8																		
Tamb	HC	IP	COP	HC	IP	COP	HC	IP	COP	HC	IP	COP	HC	IP	COP	HC	IP	COP
LWC	30	30	30	35	35	35	40	40	40	45	45	45	50	50	50	55	55	55
-15	16,00	6,30	2,54	16,00	6,89	2,32	16,00	7,45	2,15	16,00	8,10	1,98	16,00	8,48	1,89	15,20	8,96	1,70
-7	16,00	5,85	2,74	16,00	6,42	2,49	16,00	7,00	2,29	16,00	7,57	2,11	16,00	8,10	1,98	16,00	8,62	1,86
2	16,00	4,67	3,43	16,00	5,21	3,07	16,00	5,74	2,79	16,00	6,31	2,54	16,00	6,90	2,32	16,00	7,50	2,13
7	16,00	3,35	4,78	16,00	3,74	4,28	16,00	4,30	3,72	16,00	4,80	3,33	16,00	5,43	2,95	16,00	5,91	2,71
16	16,00	2,59	6,18	16,00	3,18	5,03	16,00	3,71	4,31	16,00	4,27	3,75	16,00	4,86	3,29	16,00	5,22	3,07
25	16,00	2,02	7,92	16,00	2,58	6,20	16,00	2,91	5,50	16,00	3,36	4,76	16,00	3,74	4,28	16,00	4,00	4,00

Aquarea H Generation T-CAP Mono-bloc Three Phase. Heating and Cooling - MXC

Models	WH-MXC09H3E8						WH-MXC12H9E8						WH-MXC16H9E8					
Tamb	CC	IP	EER	CC	IP	EER	CC	IP	EER	CC	IP	EER	CC	IP	EER	CC	IP	EER
LWC	7	7	7	18	18	18	7	7	7	18	18	18	7	7	7	18	18	18
18	7,00	1,36	5,15	—	—	—	7,50	1,41	5,32	—	—	—	8,50	1,70	5,00	10,00	1,70	5,88
25	7,65	1,91	4,01	—	—	—	8,90	2,16	4,12	—	—	—	14,00	4,00	3,50	14,00	2,94	4,76
35	7,00	2,21	3,17	—	—	—	10,00	3,56	2,81	—	—	—	12,20	4,76	2,56	12,20	3,50	3,49
43	6,25	2,66	2,35	—	—	—	8,00	3,01	2,66	—	—	—	7,10	3,31	2,15	9,80	3,31	2,96

HEATING & COOLING CAPACITY TABLES. Based on outlet temperature and outside temperature.

Aquarea HT Bi-bloc Three Phase. Heating Only

WH-UH09FE8

Tamb	HC	IP	COP	HC	IP	COP	HC	IP	COP	HC	IP	COP	HC	IP	COP	HC	IP	COP	HC	IP	COP	HC	IP	COP
LWC	30	30	30	35	35	35	40	40	40	45	45	45	50	50	50	55	55	55	60	60	60	65	65	65
-15	9,00	3,46	2,60	9,00	3,71	2,43	9,00	4,01	2,24	8,80	4,26	2,07	8,60	4,61	1,87	8,50	4,91	1,73	8,00	5,06	1,58	7,80	5,86	1,33
-7	9,00	3,06	2,94	9,00	3,29	2,74	9,00	3,56	2,53	8,90	3,83	2,32	8,90	4,11	2,17	8,90	4,46	2,00	8,90	4,96	1,79	8,90	5,46	1,63
2	9,00	2,43	3,70	9,00	2,61	3,45	9,00	2,91	3,09	9,00	3,21	2,80	9,00	3,55	2,54	9,00	3,88	2,32	9,00	4,35	2,07	9,00	4,76	1,89
7	9,00	1,82	4,95	9,00	1,94	4,64	9,00	2,21	4,07	9,00	2,46	3,66	9,00	2,76	3,26	9,00	3,06	2,94	9,00	3,46	2,60	9,00	3,96	2,27
16	9,00	1,46	6,16	9,00	1,56	5,77	9,00	1,81	4,97	8,90	2,02	4,41	8,80	2,31	3,81	8,60	2,52	3,41	8,20	2,77	2,96	8,20	3,18	2,58
25	12,00	1,66	7,23	12,00	1,76	6,82	12,00	2,01	5,97	10,80	2,14	5,05	10,60	2,46	4,31	10,20	2,66	3,83	9,80	2,89	3,39	9,60	3,31	2,90

WH-UH12FE8

Tamb	HC	IP	COP	HC	IP	COP	HC	IP	COP	HC	IP	COP	HC	IP	COP	HC	IP	COP	HC	IP	COP	HC	IP	COP
LWC	30	30	30	35	35	35	40	40	40	45	45	45	50	50	50	55	55	55	60	60	60	65	65	65
-15	12,00	5,16	2,33	12,00	5,53	2,17	11,00	5,51	2,00	10,60	5,53	1,92	10,30	5,63	1,83	9,70	5,76	1,68	9,00	6,01	1,50	8,00	6,11	1,31
-7	12,00	4,43	2,71	12,00	4,76	2,52	11,50	4,91	2,34	11,20	5,06	2,21	10,80	5,16	2,09	10,10	5,28	1,91	10,00	5,66	1,77	9,60	5,91	1,62
2	12,00	3,42	3,51	12,00	3,68	3,26	11,50	3,86	2,98	11,30	4,14	2,73	11,00	4,51	2,44	10,80	4,86	2,22	10,65	5,31	2,01	10,30	5,59	1,84
7	12,00	2,52	4,76	12,00	2,69	4,46	12,00	3,06	3,92	12,00	3,44	3,49	12,00	3,81	3,15	12,00	4,28	2,80	12,00	4,76	2,52	12,00	5,41	2,22
16	12,00	2,03	5,91	12,00	2,17	5,53	12,00	2,52	4,76	12,00	2,86	4,20	11,50	3,19	3,61	11,50	3,48	3,30	11,00	3,82	2,88	11,00	4,37	2,52
25	12,00	1,66	7,23	12,00	1,76	6,82	12,00	2,01	5,97	11,80	2,41	4,90	11,20	2,64	4,24	10,80	2,86	3,78	10,50	3,11	3,38	10,30	3,62	2,85

Aquarea G Generation HT Mono-bloc Three Phase. Heating Only - MHF

WH-MHF09G3E8

Tamb	HC	IP	COP	HC	IP	COP	HC	IP	COP	HC	IP	COP	HC	IP	COP	HC	IP	COP
LWC	30	30	30	35	35	35	40	40	40	45	45	45	50	50	50	55	55	55
-15	9,00	3,46	2,60	9,00	3,71	2,43	9,00	4,01	2,24	8,80	4,26	2,07	8,50	4,71	1,80	7,80	5,38	1,45
-7	9,00	3,06	2,94	9,00	3,29	2,74	9,00	3,56	2,53	8,90	3,83	2,32	8,90	4,28	2,08	9,00	5,02	1,79
2	9,00	2,43	3,70	9,00	2,61	3,45	9,00	2,91	3,09	9,00	3,21	2,80	9,00	3,72	2,42	9,00	4,37	2,06
7	9,00	1,82	4,95	9,00	1,94	4,64	9,00	2,21	4,07	9,00	2,46	3,66	9,00	2,99	3,01	9,00	3,64	2,47
25	9,00	1,52	5,92	9,00	1,70	5,29	13,20	1,88	7,02	9,00	2,16	4,17	9,00	2,63	3,42	9,00	3,20	2,81

WH-MHF12G9E8

Tamb	HC	IP	COP	HC	IP	COP	HC	IP	COP	HC	IP	COP	HC	IP	COP	HC	IP	COP
LWC	30	30	30	35	35	35	40	40	40	45	45	45	50	50	50	55	55	55
-15	12,00	5,16	2,33	12,00	5,53	2,17	11,00	5,51	2,00	10,80	5,49	1,97	9,70	5,52	1,76	8,00	5,61	1,43
-7	12,00	4,43	2,71	12,00	4,76	2,52	11,50	4,91	2,34	11,20	5,06	2,21	10,10	5,06	2,00	9,60	5,43	1,77
2	12,00	3,42	3,51	12,00	3,68	3,26	11,50	3,86	2,98	11,30	4,14	2,73	10,80	4,66	2,32	10,30	5,13	2,01
7	12,00	2,52	4,76	12,00	2,69	4,46	12,00	3,06	3,92	12,00	3,44	3,49	12,00	4,10	2,93	12,00	4,97	2,41
25	12,00	2,03	5,91	12,00	2,36	5,08	12,00	2,69	4,46	12,00	3,02	3,97	12,00	3,61	3,32	12,00	4,37	2,75

EXAMPLES OF INSTALLATIONS

Aquarea H Generation: Bivalent with buffer tank and mixing valve.

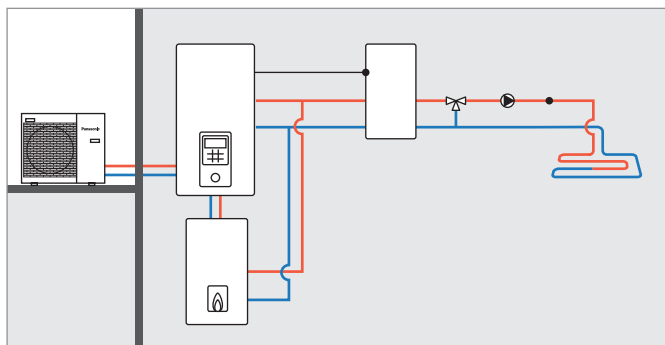

Aquarea H Generation: Buffer tank with solar and mixing valve.

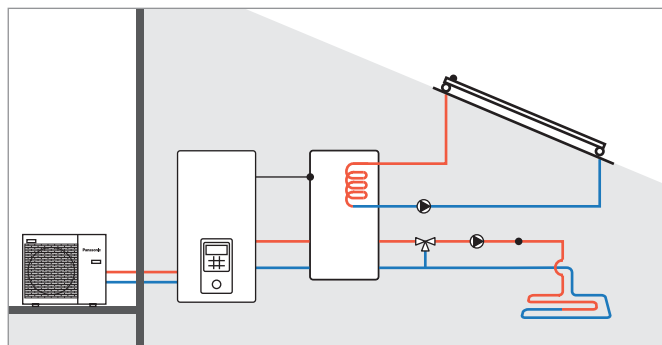

Aquarea H Generation: 2 zones with external kit without buffer tank.

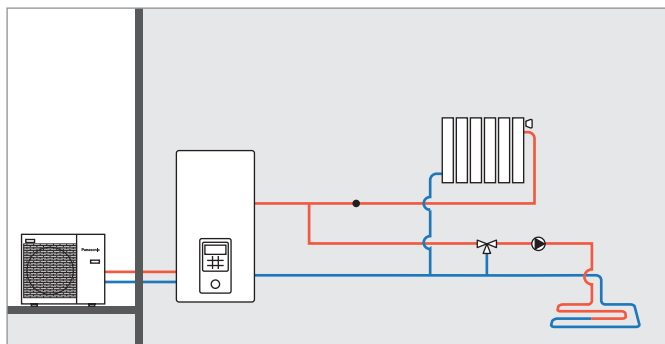

Aquarea H Generation: 2 zones with external kit, buffer tank and swimming pool.

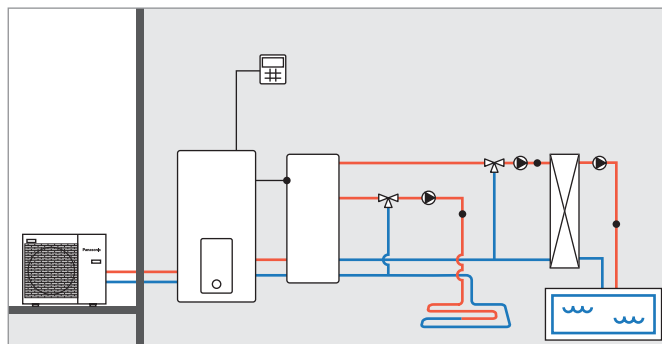

Aquarea All in One H Generation: 2 zones with external kit, without buffer tank.

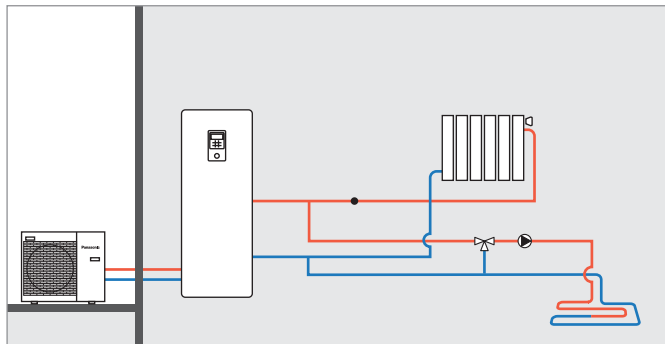

Aquarea All in One 2 zones H Generation: 2 zones built-in, without buffer tank.

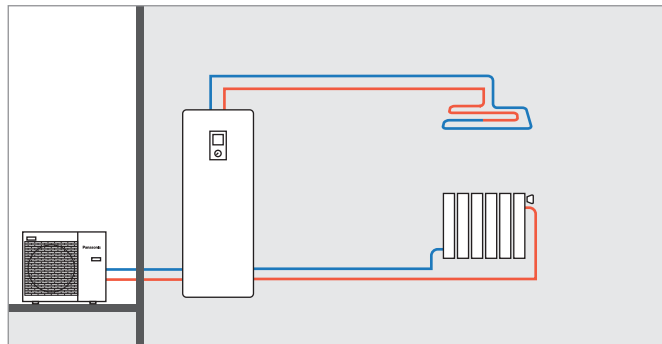

PANASONIC DOMESTIC AIR TO AIR HEAT PUMP



Panasonic has developed a range of products designed for you, better than ever before. Above all, it is also a range for air conditioning professionals, such as yourself, thanks to its broad range of products which are capable of conditioning rooms of all sizes – always with optimal efficiency and incomparable ease of installation.

heatcharge

FLAGSHIP

ETHEREA

R32 Full Domestic range.

All Domestic has transformed to R32 with excellent performance. Panasonic has not just fully adapted to new refrigerant, the new units has been design to maximize the advantages of new refrigerant for Wall and Floor Console.



New HZ Flagship.

With new nanoe™ X air-purifying system: outstanding efficiency A+++ and comfort combined with a breakthrough design. Built-in WLAN for internet control.

LZ – perfect for replacing an older heat pump.

Due to its low height, LZ is perfect as a replacement heat pump to be placed above the entrance door.



New stylish Floor Console.

The new R32 Floor Console has been designed for European market from Scratch. New Floor Consoles purifies the air with nanoe™ X, quiet operation, high efficiency, new design control remote and accurate design are its attributes.

Panasonic Comfort Cloud.

Advanced smartphone control for RAC Range. Control air to air heat pump with Panasonic Comfort Cloud with full functions available in the unit plus additional functions only available thru the Cloud from wherever and whenever.



R32 REFRIGERANT GAS



A ‘small’ change that changes everything

Not everyone is ready for change. Indeed, there are some who resist the future. But at Panasonic we will keep believing in technologies that improve people’s lives. Which is why we are now presenting a generation of air conditioners with R32, an innovative refrigerant in all ways imaginable: it is easy to install, and compared to most other refrigerants it has a much lower environmental impact and saves energy. The result? Greater wellbeing for people and for the planet. Because there will always be people who resist change. But we say: Goodbye yesterday. Hello R32.

Today Panasonic. Tomorrow everyone.

European regulation EU 517/2014 makes the replacement of fluorinated gases (F-gases) compulsory, such as R410A, for environmental reasons,

although it also grants a transition period from 2017 to 2030. Must we wait? No. Our commitment to innovation is not hampered by dates. Which is why we are jumping the gun and are now presenting our generation of air conditioners that employ the R32 refrigerant.

HCFC phase-down schedule.

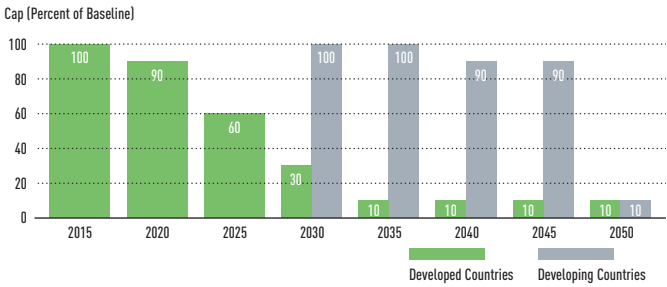

* By replacing R22 with R32 we are significantly reducing the ozone depletion potential of our air conditioners. The use of air conditioning is rapidly increasing in developing countries thus making it increasingly necessary to use refrigerants with low global warming potential.

Goodbye yesterday

The generation of air conditioners with R32 represents innovation in every way. Shall we list them?

1. Installation innovation.

- Extremely easy to install, practically the same as R410A. (Just remember to verify that the pressure gauge and vacuum pump are compatible with R32)
- This refrigerant is 100 % pure, which makes it easier to recycle and reuse

2. Environmental innovation.

- Zero impact on the ozone layer
- 75 % less impact on global warming vs R410A

	R410A	R32
Composition	Blend of 50 % R32 + 50 % R125	100 % R32. (No blend)
GWP (Global Warming Potential)	2087,5	675
ODP (Ozone Depletion Potential)	0	0

R32 is a refrigerant with just one-third the global warming potential of R410A, meaning less risk of damage to the environment.

3. Economic and energy consumption innovation.

- Lower cost and greater savings:
 - 30 % less refrigerant
- Higher energy efficiency than R410A

LCCP: Life Cycle Climate Performance (lower global warming impact). Safety: Low toxicity level.



A COMPLETE SELECTION FOR NORDIC HOUSEHOLDS

Page **Kit 1x1**

Wall Mounted VZ Heatcharge Inverter+ • R32 GAS

P. 54



CS-VZ9SKE



CS-VZ12SKE

NEW Wall Mounted HZ Flagship Inverter+ • R32 GAS

P. 56



CS-HZ25UKE



CS-HZ35UKE

Wall Mounted LZ Retro Fit Inverter+ • R32 GAS

P. 58



CS-LZ25TKE



CS-LZ35TKE

Wall Mounted NZ / QZ Etherea Inverter+ White / Matt • R32 GAS

P. 60



CS-NZ25TKE



CS-NZ35TKE



CS-NZ50TKE



CS-QZ9SKE

Wall Mounted CZ Inverter • R32 GAS

P. 61



CS-CZ25TKE



CS-CZ35TKE

NEW Floor Console Inverter+ • R32 GAS

P. 62



CS-Z25UFEAW-1









CS-Z35UFEAW-1

Choose the correct model

In order to maximize comfort and savings, it is important that you choose the correct model of your heat pump. A heat pump with too little or too much power will not be able to provide the desired savings. A heat pump with an insufficient air flow rate will not manage to distribute heat in a larger building. A heat pump without remote control reduces comfort and control in the summer house.

Please contact an installer/dealer for assistance in choosing the correct model or use the guide below.

VZ Heatcharge	HZ Flagship	LZ Retro Fit 249	NZ Etherea	CZ Basic Inverter	Floor Console
					
The top model for cold areas	The best seller for larger houses	The perfect replacement model	The design model	The budget model	The floor model
Tested by 3rd party laboratory down to -35 °C					
✓ SP ¹⁾	✓ DTI ²⁾	✓ DTI ²⁾			✓ DTI ²⁾
Lowest sound level (18 dB(A))					
✓	✓	✓			
Air purification					
✓ nanoe™	✓ nanoe™ X	✓	✓		✓ nanoe™ X
Maximum capacity					
9,20 kW	7,75 kW	7,65 kW	7,20 kW	6,70 kW	6,20 kW
Home 190-230 sq. m					
✓					
Home 150-190 sq. m					
✓	✓	✓			
Home 100-150 sq. m					
✓	✓	✓	✓	✓	✓
Home 50-100 sq. m					
	✓	✓	✓	✓	✓
Summer House					
✓	✓	✓	✓	✓	✓
Garage / Shed / Permit-free building					
			✓	✓	✓
SCOP					
6,20 ◀A+++	5,38 ³⁾ ◀A+++	5,17 ³⁾ ◀A+++ ⁴⁾	4,60 ◀A++	4,10 ◀A+	4,79 ³⁾ ◀A++
No cold air dumping when defrosting					
✓					
Highest energy class (A+++)					
✓	✓	✓			
R32 Gas					
✓	✓	✓	✓	✓	✓
Compatible with Internet control					
✓	✓	✓	✓	✓	✓
Summer cottage function					
✓	✓	✓	✓	✓	✓
Econavi					
✓			✓		
Replacement model					
		✓	✓		

1) -35°C tested by SP, in accordance with EN 14511:2013 and SP Method 1721 (this temperature is not guaranteed by the factory). 2) -35°C tested by DTI, an independent test laboratory, in accordance with EN 14511:2013 (this temperature is not guaranteed by the factory). 3) SCOP tested by the independent testing laboratory, DTI, in accordance with EN 14825:2016. 4) A+++ has been calculated on the basis of the SCOP test performed by the Danish Technological Institute. The test report from the Danish Technological Institute can be found at: lz25test.panasonic.se

HEATCHARGE. ENERGY CHARGE SYSTEM



Heating power and efficiency

- Energy Charge System. Heat storage unit which features Non-Stop heating and fast heating function
- Higher efficiency and comfort with Econavi sunlight detection
- More powerful airflow to quickly reach the desired temperature

Panasonic's new full line-up of A+++ heat pumps.

In response to the Kyoto Protocol, the European Union set some challenging targets for the reduction in greenhouse-gas emissions. By the year 2020, across the member states, the EU wants to have achieved the following objectives:

- A 20 % cut in greenhouse gas emissions (from 1990 base levels)
- The share of renewables in the energy mix to increase by 20 %
- An overall reduction of 20 % in energy consumption

Conventional. The room gradually becomes cold.

Defrost operation: About 11 to 15 min. Fall in room temperature: About 5 to 6 °C

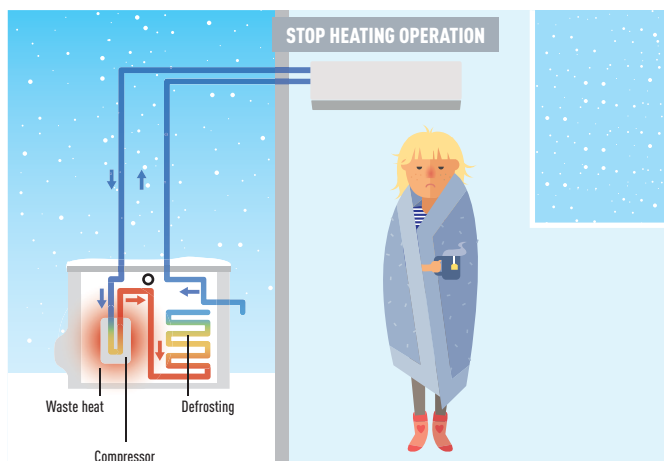

Heatcharge. The room is thoroughly warmed.

Defrost operation: About 5 to 6 min. Fall in room temperature: About 1 to 2 °C

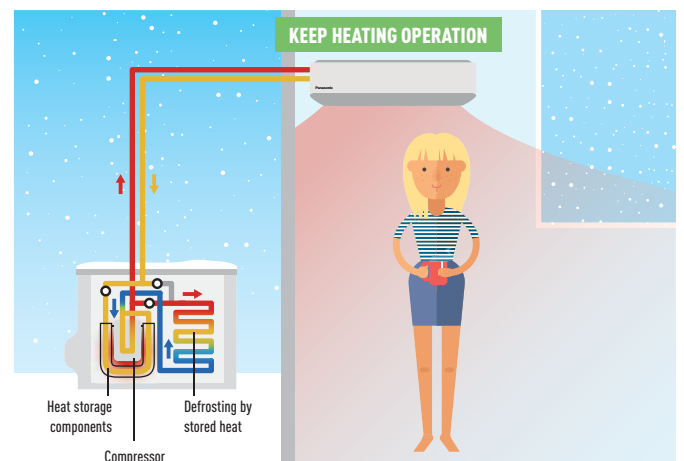

* Defrost operation time and how low room temperature falls differ depending on the environment in which the unit is being used (how insulated and airtight and room is), operation conditions, and temperature conditions.

* Output air temperature falls during defrost operation. How low room temperature falls differs depending on the environment in which the unit is being used (how insulated and airtight and room is), operation conditions, and temperature conditions.

* In environments where a lot of frost accumulates, heating may stop during defrost operation.



Splits 1x1

R32

The product is P-labelled
The P-labelling means that the product fulfils legal and regulatory requirements, but also in most cases, other, higher requirements that meet market demands. P-labelling means that the product is type approved and that the manufacturer's quality controls are monitored by SP.



CZ-TACG1
Panasonic
WLAN kit for
internet control.



Wall Mounted VZ Heatcharge Inverter+ • R32 GAS

Maximum capacity			7,80 kW	9,20 kW
Indoor unit			CS-VZ9SKE	CS-VZ12SKE
Outdoor unit			CU-VZ9SKE	CU-VZ12SKE
Heating capacity	Nominal (Min - Max)	kW	3,60(0,60 - 7,80)	4,20(0,60 - 9,20)
COP ¹⁾		W/W	5,63 A	5,04 A
Heating capacity at -7 °C		kW	5,00	5,60
COP at -7 °C ¹⁾		W/W	2,07	2,00
Heating capacity at -15 °C		kW	4,80	5,22
COP at -15 °C ¹⁾		W/W	1,94	1,90
Heating capacity at -25 °C (tested by SP)		kW	3,72	3,67
COP at -25 °C (tested by SP)		W/W	1,63	1,50
Heating capacity at -35 °C (tested by SP)		kW	2,51	2,44
COP at -35 °C (tested by SP)		W/W	1,32	1,15
SCOP ²⁾		W/W	6,20 A+++	5,90 A+++
Pdesign at -10 °C		kW	3,6	4,2
Input power heating	Nominal (Min - Max)	kW	0,64(0,14 - 2,72)	0,83(0,14 - 3,16)
Annual energy consumption ³⁾		kWh/a	812	995
Cooling capacity	Nominal (Min - Max)	kW	2,50(0,60 - 3,00)	3,50(0,60 - 4,00)
SEER ²⁾		W/W	10,50 A+++	10,00 A+++
Pdesign (cooling)		kW	2,5	3,5
Input power cooling	Nominal (Min - Max)	kW	0,43(0,14 - 0,61)	0,80(0,14 - 0,98)
Annual energy consumption ³⁾		kWh/a	83	122
Indoor unit				
Power source		V	230	230
Recommended fuse		A	16	16
Connection indoor / outdoor		mm ²	4 x 1,5	4 x 1,5
Air volume	Heat / Cool (Hi)	m ³ /min	15,5/12,5	15,9/12,9
Sound pressure ⁴⁾	Heat (Hi / Lo / Q-Lo)	dB(A)	44/26/18	45/29/18
	Cool (Hi / Lo / Q-Lo)	dB(A)	44/27/18	45/33/18
Dimension	H x W x D	mm	295 x 798 x 375	295 x 798 x 375
Net weight		kg	14,5	14,5
Outdoor unit				
Air volume	Heat / Cool (Hi)	m ³ /min	33,1/33,1	33,9/35,4
Sound pressure ⁴⁾	Heat / Cool (Hi)	dB(A)	49/49	50/50
Dimension ⁵⁾	H x W x D	mm	630 x 799 x 299	630 x 799 x 299
Net weight		kg	39,5	39,5
Piping connections	Liquid pipe	Inch (mm)	1/4(6,35)	1/4(6,35)
	Gas pipe	Inch (mm)	3/8(9,52)	3/8(9,52)
Pipe length range		m	3 - 15	3 - 15
Elevation difference (in/out) ⁶⁾		m	12	12
Pipe length for additional gas		m	7,5	7,5
Additional gas amount		g/m	20	20
Refrigerant (R32)		kg/TCO ₂ Eq.	1,05/0,70875	1,10/0,7425
Operating range	Heat Min - Max	°C	-25 - +24	-25 - +24
	Cool Min - Max	°C	-10 - +43	-10 - +43
Lowest outdoor temperature tested by 3rd party laboratory ⁷⁾		°C	-35	-35

Accessories

CZ-TACG1	NEW Panasonic WLAN kit for internet control
CZ-CAPRA1	RAC interface adapter for integration into P Link

Accessories

PAW-SMSCONTROL	Control by SMS (need additional SIM card)
-----------------------	---

1) EER and COP calculation is based in accordance to EN14511. 2) Energy Label Scale from A+++ to D. 3) The annual energy consumption is calculated in accordance to EU/626/2011. 4) The sound pressure of the units shows the value measured of a position 1 m in front of the main body and 0,8 m below the unit. The sound pressure is measured in accordance with Eurovent 6/C/006-97 specification. 5) Add 70 mm for piping port. 6) When installing the outdoor unit at a higher position than the indoor unit. 7) Tested by 3rd party laboratory, SP, according to EN14511:2013 and SP Method 1721, this temperature is not guaranteed by Factory.



SCOP and SEER: For CS-VZ9SKE. -35 °C HEATING MODE: Heating performance tested at -35 °C by SP, European third party laboratory. INTERNET CONTROL: Optional.

NEW NANOE™ X. QUALITY AIR FOR LIFE



No matter where you are on planet earth, air is an essential part in your life. We're working to help every person enjoy better health and comfort by nanoe™ air purifier technologies.

What is nanoe™?

nano-technology + electric =



nanoe™ is nano-sized electrostatic atomised water particles that are rich in OH radicals.

nanoe™ is generated from moisture in the air that contains highly reactive components known as hydroxyl (OH) radicals.

Its effectiveness on bacteria, viruses and odour compounds inhibition depends on the number of OH radical, which is generated at the rate of 480 billion per second.

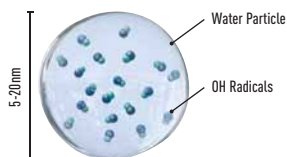

**480 BILLION
OH RADICALS /
PER SECOND**

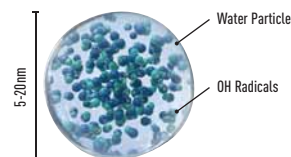

**4800 BILLION
OH RADICALS /
PER SECOND**

nanoe™ X deodorises and inhibits certain bacteria & viruses



nanoe™ X contains 10X times¹ more OH radicals.

The newly developed nanoe™ X device produces 10x times more OH radicals (4800 billion)¹ than regular nanoe™ device. Greater amounts of OH radicals contained in nanoe™ X lead to outstanding effects in bacteria, viruses and allergens inhibition as well as deodorisation. A fresher and cleaner home awaits you.

1) Based on Panasonic Survey.

How nanoe™ and nanoe™ X keeps air fresh & clean

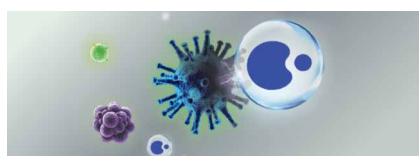

nanoe™ and nanoe™ X reaches bacteria.



OH radicals take away hydrogen from bacteria.



OH radicals transform hydrogen in bacteria to water and inhibit bacterial activity.

Splits 1x1

R32



CZ-TACG1
Built-in Panasonic
WLAN kit for internet
control.



NEW Wall Mounted HZ Flagship Inverter+ • R32 GAS

Maximum capacity			7,30 kW	7,75 kW
Indoor Unit			CS-HZ25UKE	CS-HZ35UKE
Outdoor Unit			CU-HZ25UKE	CU-HZ35UKE
Heating capacity	Nominal (Min - Max)	kW	3,20 (0,85 - 7,30)	4,20 (0,85 - 7,75)
COP ¹⁾		W/W	5,61 A	5,00 A
Heating capacity at -7 °C ²⁾		kW	4,70	4,75
COP at -7 °C ¹⁾		W/W	2,44	2,44
Heating capacity at -15 °C ²⁾		kW	4,55	4,65
COP at -15 °C ¹⁾		W/W	2,37	2,36
Heating capacity at -20 °C ²⁾		kW	4,00	4,05
COP at -20 °C ¹⁾		W/W	2,19	2,17
Heating capacity at -25 °C ²⁾		kW	3,40	3,50
COP at -25 °C ¹⁾		W/W	2,00	2,00
SCOP ³⁾	W/W		5,20 A+++	5,10 A+++
SCOP tested by 3rd party laboratory DTI ⁴⁾			5,38 ⁴⁾	—
Pdesign at -10 °C		kW	3,00	3,80
Input power heating	Nominal (Min - Max)	kW	0,57 (0,17 - 2,15)	0,84 (0,17 - 2,27)
Annual energy consumption ⁵⁾		kWh/a	808	1043
Cooling capacity	Nominal (Min - Max)	kW	2,50 (0,85 - 3,00)	3,50 (0,85 - 4,00)
SEER ³⁾	W/W		7,80 A++	7,60 A++
Pdesign (cooling)		kW	2,50	3,50
Input power cooling	Nominal (Min - Max)	kW	0,46 (0,17 - 0,67)	0,83 (0,17 - 0,99)
Annual energy consumption ⁵⁾		kWh/a	112	161
Indoor Unit				
Power source		V	230	230
Recommended fuse		A	10	10
Air volume	Heat / Cool	m ³ /min	15,6 / 14,0	15,6 / 14,0
Moisture removal volume		U/h	1,5	2,0
Sound pressure ⁶⁾	Heat (Hi / Lo / Q-Lo)	dB(A)	45 / 24 / 18	45 / 25 / 18
	Cool (Hi / Lo / Q-Lo)	dB(A)	44 / 25 / 20	44 / 28 / 20
Dimension	H x W x D	mm	295 x 870 x 230	295 x 870 x 230
Net weight		kg	10	10
Outdoor Unit				
Air volume	Heat / Cool	m ³ /min	32,7 / 32,7	35,6 / 34,4
Sound pressure ⁶⁾	Heat — Cool (Hi / Lo)	dB(A)	47 / 44 — 46 / 43	50 / 47 — 48 / 45
Dimension ⁷⁾	H x W x D	mm	622 x 824 x 299	622 x 824 x 299
Net weight		kg	36	36
Piping connections	Liquid pipe	Inch (mm)	1/4 (6,35)	1/4 (6,35)
	Gas pipe	Inch (mm)	3/8 (9,52)	3/8 (9,52)
Pipe length range		m	3 - 20	3 - 20
Elevation difference (in/out) ⁸⁾		m	10	10
Pipe length for additional gas		m	7,5	7,5
Additional gas amount		g/m	20	20
Refrigerant (R32)		kg/TCO ₂ Eq.	1,12 / 0,756	1,12 / 0,756
Operating range	Heat Min - Max	°C	-25 - +24	-25 - +24
	Cool Min - Max	°C	+16 - +43	+16 - +43
Lowest outdoor temperature tested by 3rd party laboratory ⁹⁾			°C	-35

Accessories

CZ-CAPRA1 RAC interface adapter for integration into P Link

Accessories

CZ-RD514C Wired remote controller for Wall Mounted and Floor Console

1) EER and COP calculation is based in accordance to EN14511. 2) Capacity of the heat pump is tested with powerful mode with deice mode included. 3) SCOP and SEER values are Panasonic Factory official result, Energy Label Scale from A+++ to D. 4) SCOP Tested by 3rd Party laboratory DTI under EN14825:2016. 5) The annual energy consumption is calculated in accordance to EU/626/2011. 6) The sound pressure of the units shows the value measured of a position 1 m in front of the main body and 0,8 m below the unit. The sound pressure is measured in accordance with Eurovent 6/C/006-97 specification. Q-Lo: Quiet mode. Lo: The lowest fan speed. 7) Add 70 mm for piping port. 8) When installing the outdoor unit at a higher position than the indoor unit. 9) Tested by 3rd party laboratory, DTI, according to EN14511:2013, this temperature is not guaranteed by Factory.



SCOP and SEER: For CS-HZ25UKE. -35 °C HEATING MODE: For CS-HZ25UKE heating performance tested at -35 °C by SP, European third party laboratory. INTERNET CONTROL: Built-in.

LZ – PERFECT FOR REPLACING AN OLDER HEAT PUMP



The LZ series is perfect for replacing a 7–10 year old heat pump

The LZ models are efficient and reliable even at outdoor temperatures as low as -35 °C.

Due to its well-thought-out design, LZ is perfect as a replacement pump.

Only 249 mm high

The models in the LZ series are perfect for replacing a 7–10 year old heat pump.



Perfect as a replacement pump

LZ's design and dimensions are adapted to facilitate the replacement of an older Panasonic model. For example, the height of the inner section is the same as the older CKP and DKE models. This means that the existing position, e.g. above the outer door, can be retained. This is often not possible as the height of modern inner sections has generally increased. It is not necessary to replace the brackets behind the heat pump either and the pipe size is identical. Replacing a 10 year old heat pump with a new one is often a good investment. Modern heat pumps have a higher energy efficiency which benefits both the environment and your wallet. You will also benefit from new practical functions such as maintenance heating, remote control, better air purification and a timer setting.



Splits 1x1

R32



CZ-TACG1
Panasonic WLAN kit for internet control.

Wall Mounted LZ Retro Fit 249 Inverter+ • R32 GAS

Maximum capacity			6,55 kW	7,65 kW
Indoor Unit			CS-LZ25TKE	CS-LZ35TKE
Outdoor Unit			CU-LZ25TKE	CU-LZ35TKE
Heating capacity	Nominal (Min - Max)	kW	3,20(0,85 - 6,55)	4,20(0,85 - 7,65)
COP ¹⁾		W/W	5,12 A	4,72 A
Heating capacity at -7 °C ²⁾		kW	4,00	4,60
COP at -7 °C ¹⁾		W/W	2,52	2,35
Heating capacity at -15 °C ²⁾		kW	3,90	4,35
COP at -15 °C ¹⁾		W/W	2,27	2,25
Heating capacity at -20 °C ²⁾		kW	3,30	3,70
COP at -20 °C ¹⁾		W/W	2,04	2,03
Heating capacity at -25 °C ²⁾		kW	2,70	3,10
COP at -25 °C ¹⁾		W/W	1,83	1,83
SCOP ³⁾		W/W	5,00 A++	4,90 A++
SCOP tested by 3rd party laboratory DTI ⁴⁾		W/W	5,17 ⁴⁾ A+++ ⁵⁾	—
Pdesign at -10 °C		kW	—	—
Input power heating	Nominal (Min - Max)	kW	0,63(0,17 - 1,77)	0,89(0,17 - 2,30)
Annual energy consumption ⁶⁾		kWh/a	840	1086
Cooling capacity	Nominal (Min - Max)	kW	2,50(0,85 - 3,00)	3,50(0,85 - 4,00)
SEER ³⁾		W/W	7,60 A++	7,40 A++
Pdesign (cooling)		kW	—	—
Input power cooling	Nominal (Min - Max)	kW	0,51(0,17 - 0,69)	0,86(0,17 - 1,08)
Annual energy consumption ⁶⁾		kWh/a	115	166
Indoor Unit				
Power source		V	240	240
Recommended fuse		A	10	10
Air volume	Heat / Cool	m ³ /min	12,5/9,3	13,0/10,5
Moisture removal volume		U/h	—	—
Sound pressure ⁷⁾	Heat (Hi / Lo / Q-Lo)	dB(A)	45/29/18	46/30/19
	Cool (Hi / Lo / Q-Lo)	dB(A)	40/25/21	43/28/21
Dimension	H x W x D	mm	249 x 790 x 355	249 x 790 x 355
Net weight		kg	—	—
Outdoor Unit				
Air volume	Heat / Cool	m ³ /min	—	—
Sound pressure ⁷⁾	Heat / Cool (Hi)	dB(A)	—	—
Dimension ⁸⁾	H x W x D	mm	622 x 824 x 299	622 x 824 x 299
Net weight		kg	—	—
Piping connections	Liquid pipe	Inch (mm)	—	—
	Gas pipe	Inch (mm)	—	—
Pipe length range		m	—	—
Elevation difference (in/out) ⁹⁾		m	—	—
Pipe length for additional gas		m	—	—
Additional gas amount		g/m	—	—
Refrigerant (R32)		kg/TCO ₂ Eq.	—	—
Operating range	Heat Min - Max	°C	-25 - +24	-25 - +24
	Cool Min - Max	°C	-15 - +43	-15 - +43
Lowest outdoor temperature tested by 3rd party laboratory ¹⁰⁾		°C	-35	—

Accessories

CZ-TACG1	NEW Panasonic WLAN kit for internet control
CZ-CAPRA1	RAC interface adapter for integration into P Link

Accessories

PAW-SMSCONTROL	Control by SMS (need additional SIM card)
CZ-RD514C	Wired remote controller for Wall Mounted and Floor Console

1) EER and COP calculation is based in accordance to EN14511. 2) Capacity of the heat pump is tested with powerful mode with deice mode included. 3) Energy Label Scale from A+++ to D. 4) SCOP tested by the independent testing laboratory, DTI, in accordance with EN 14825:2016. 5) A+++ has been calculated on the basis of the SCOP test performed by the Danish Technological Institute. The test report from the Danish Technological Institute can be found at: lz25test.panasonic.se 6) The annual energy consumption is calculated in accordance to EU/626/2011. 7) The sound pressure of the units shows the value measured of a position 1 m in front of the main body and 0,8 m below the unit. The sound pressure is measured in accordance with Eurovent 6/C/006-97 specification. Q-Lo: Quiet mode. Lo: The lowest fan speed. 8) Add 70 mm for piping port. 9) When installing the outdoor unit at a higher position than the indoor unit. 10) Tested by 3rd party laboratory, DTI, according to EN14511:2013, this temperature is not guaranteed by Factory.

SCOP and SEER: For CS-LZ25TKE. SUPER QUIET: For CS-LZ35TKE. -35 °C HEATING MODE: For CS-LZ25TKE heating performance tested at -35 °C by SP, European third party laboratory. INTERNET CONTROL: Optional. * SCOP tested by the independent testing laboratory, DTI, in accordance with EN 14825:2016 - A+++ has been calculated on the basis of the SCOP test performed by the Danish Technological Institute. The test report from the Danish Technological Institute can be found at: lz25test.panasonic.se

Rating Conditions: Cooling Indoor 27 °C DB / 19 °C WB. Cooling Outdoor 35 °C DB / 24 °C WB. Heating Indoor 20 °C DB. Heating Outdoor 7 °C DB / 6 °C WB. (DB: Dry Bulb; WB: Wet Bulb)
Specifications subject to change without notice. For detailed information about ErP / Energy Labelling, please visit our websites www.aircon.panasonic.eu or www.ptc.panasonic.eu.

R32 Splits 1x1



Wall Mounted NZ / QZ Etherea Inverter+ White / Matt • R32 GAS

Maximum capacity			6,00 kW	6,00 kW	7,20 kW	8,20 kW
Indoor Unit			CS-NZ25TKE	CS-QZ9SKE	CS-NZ35TKE	CS-NZ50TKE
Outdoor Unit			CU-NZ25TKE	CU-QZ9SKE	CU-NZ35TKE	CU-NZ50TKE
Heating capacity	Nominal (Min - Max)	kW	3,40 (0,85 - 6,00)	3,40 (0,85 - 6,00)	4,00 (0,85 - 7,20)	5,80 (0,98 - 8,20)
COP ¹⁾		W/W	4,86 A	4,86 A	4,40 A	3,15 B
Heating capacity at -7 °C ²⁾		kW	3,80	3,80	4,50	5,10
COP at -7 °C ¹⁾		W/W	2,45	2,45	2,09	2,27
Heating capacity at -15 °C ²⁾		kW	3,20	3,20	4,10	4,90
COP at -15 °C ¹⁾		W/W	2,18	2,18	2,09	2,23
Heating capacity at -20 °C ²⁾		kW	2,60	2,60	3,50	4,15
COP at -20 °C ¹⁾		W/W	1,93	1,93	1,98	2,11
Heating capacity at -25 °C ²⁾		kW	2,00	2,00	2,90	3,70
COP at -25 °C ¹⁾		W/W	1,60	1,60	1,81	1,90
SCOP ³⁾	W/W		4,60 A++	4,60 A++	4,60 A++	4,40 A+
Pdesign at -10 °C		kW	2,80	2,80	3,60	4,40
Input power heating	Nominal (Min - Max)	kW	0,70 (0,17 - 1,63)	0,70 (0,17 - 1,63)	0,91 (0,17 - 2,30)	1,52 (0,34 - 2,60)
Annual energy consumption ⁴⁾		kWh/a	852	852	1096	1400
Cooling capacity	Nominal (Min - Max)	kW	2,50 (0,85 - 3,00)	2,50 (0,85 - 3,00)	3,50 (0,85 - 4,00)	5,00 (0,98 - 6,00)
SEER ³⁾	W/W		7,40 A++	7,40 A++	7,10 A++	7,30 A++
Pdesign (cooling)		kW	2,50	2,50	3,50	5,00
Input power cooling	Nominal (Min - Max)	kW	0,51 (0,17 - 0,70)	0,51 (0,17 - 0,70)	0,86 (0,17 - 1,10)	1,44 (0,28 - 1,99)
Annual energy consumption ⁴⁾		kWh/a	118	255	173	240
Indoor Unit						
Power source		V	230	230	230	230
Recommended fuse		A	10	10	10	13
Air volume	Heat / Cool	m³/min	12,1 / 10,4	12,1 / 10,4	12,4 / 11,1	19,3 / 17,9
Moisture removal volume		l/h	1,5	1,5	2,0	2,8
Sound pressure ⁵⁾	Heat (Hi / Lo / Q-Lo)	dB(A)	42 / 27 / 19	42 / 27 / 19	44 / 30 / 19	44 / 37 / 34
	Cool (Hi / Lo / Q-Lo)	dB(A)	39 / 25 / 21	39 / 25 / 21	42 / 28 / 21	44 / 37 / 34
Dimension	H x W x D	mm	295 x 919 x 194	295 x 919 x 194	295 x 919 x 194	295 x 1070 x 255
Net weight		kg	9	9	10	13
Outdoor Unit						
Air volume	Heat / Cool	m³/min	32,2 / 32,2	32,2 / 32,2	35,6 / 34,4	39,2 / 39,2
Sound pressure ⁵⁾	Heat — Cool (Hi / Lo)	dB(A)	48 / 45 — 46 / 43	48 / 45 — 46 / 43	50 / 47 — 48 / 45	49 — 48
Dimension ⁶⁾	H x W x D	mm	622 x 824 x 299	622 x 824 x 299	622 x 824 x 299	701 x 875 x 320
Net weight		kg	37	37	38	47
Piping connections	Liquid pipe	Inch (mm)	1/4 (6,35)	1/4 (6,35)	1/4 (6,35)	1/4 (6,35)
	Gas pipe	Inch (mm)	3/8 (9,52)	3/8 (9,52)	3/8 (9,52)	1/2 (12,70)
Pipe length range		m	3 - 20	3 - 20	3 - 20	3 - 20
Elevation difference (in/out) ⁷⁾		m	10	10	10	15
Pipe length for additional gas		m	7,5 / 10	7,5 / 10	7,5 / 10	7,5 / 20
Additional gas amount		g/m	10	10	10	20
Refrigerant (R32)		kg / TCO ₂ Eq.	0,96 / 0,648	0,96 / 0,648	1,00 / 0,675	—
Operating range	Heat Min ~ Max	°C	-25 ~ +24	-25 ~ +24	-25 ~ +24	-25 ~ +24
	Cool Min ~ Max	°C	-15 ~ +43	-15 ~ +43	-15 ~ +43	-15 ~ +43

Accessories

- CZ-TACG1** NEW Panasonic WLAN kit for internet control
- CZ-CAPRA1** RAC interface adapter for integration into P Link

Accessories

- PAW-SMCONTROL** Control by SMS (need additional SIM card)
- CZ-RD514C** Wired remote controller for Wall Mounted and Floor Console

1) EER and COP calculation is based in accordance to EN14511. 2) Capacity of the heat pump is tested with powerful mode with deice mode included. 3) Energy Label Scale from A+++ to D. 4) The annual energy consumption is calculated in accordance to EU/626/2011. 5) The sound pressure of the units shows the value measured of a position 1 m in front of the main body and 0,8 m below the unit. The sound pressure is measured in accordance with Eurovent 6/C/006-97 specification. Q-Lo: Quiet mode. Lo: The lowest fan speed. 6) Add 70 mm for piping port. 7) When installing the outdoor unit at a higher position than the indoor unit.



SCOP and SEER: For CS-NZ25TKE and CS-QZ9SKE. SUPER QUIET: For CS-NZ25TKE, CS-QZ9SKE and CS-NZ35TKE. INTERNET CONTROL: Optional. IF DESIGN AWARD 2017: Etherea White awarded with the prestigious IF Design Award 2017.

Splits 1x1

R32



CZ-TACG1
Panasonic WLAN kit
for internet control.



Wall Mounted CZ Inverter • R32 GAS

Maximum capacity			5,20 kW	6,70 kW
Indoor Unit			CS-CZ25TKE	CS-CZ35TKE
Outdoor Unit			CU-CZ25TKE	CU-CZ35TKE
Heating capacity	Nominal (Min - Max)	kW	3,40(0,85 - 5,20)	4,00(0,85 - 6,70)
COP ¹⁾		W/W	4,66 A	4,08 A
Heating capacity at -7 °C ²⁾		kW	3,30	4,05
COP at -7 °C ¹⁾		W/W	2,54	2,19
Heating capacity at -15 °C ²⁾		kW	2,70	3,60
COP at -15 °C ¹⁾		W/W	2,16	2,11
Heating capacity at -20 °C ²⁾		kW	2,10	3,00
COP at -20 °C ¹⁾		W/W	1,91	1,88
Heating capacity at -25 °C ²⁾		kW	1,50	2,40
COP at -25 °C ¹⁾		W/W	1,50	1,60
SCOP ³⁾		W/W	4,10 A+	4,10 A+
Pdesign at -10 °C		kW	2,80	3,60
Input power heating	Nominal (Min - Max)	kW	0,73(0,18 - 1,45)	0,98(0,18 - 2,00)
Annual energy consumption ⁴⁾		kWh/a	956	1229
Cooling capacity	Nominal (Min - Max)	kW	2,50(0,85 - 3,00)	3,50(0,85 - 4,00)
SEER ³⁾		W/W	6,60 A++	6,30 A++
Pdesign (cooling)		kW	2,50	3,50
Input power cooling	Nominal (Min - Max)	kW	0,54(0,19 - 0,73)	0,94(0,19 - 1,14)
Annual energy consumption ⁴⁾		kWh/a	133	194
Indoor Unit				
Power source		V	230	230
Recommended fuse		A	10	10
Air volume	Heat / Cool	m ³ /min	11,8/11,1	12,8/12,0
Moisture removal volume		l/h	1,5	2,0
Sound pressure ⁵⁾	Heat (Hi / Lo / Q-Lo)	dB(A)	40/27/21	42/33/21
	Cool (Hi / Lo / Q-Lo)	dB(A)	39/25/22	42/28/22
Dimension	H x W x D	mm	290 x 850 x 199	290 x 850 x 199
Net weight		kg	8	8
Outdoor Unit				
Air volume	Heat / Cool	m ³ /min	29,7/31,3	32,1/32,9
Sound pressure ⁵⁾	Heat – Cool (Hi / Lo)	dB(A)	47/44 – 46/43	50/47 – 48/45
Dimension ⁶⁾	H x W x D	mm	622 x 824 x 299	622 x 824 x 299
Net weight		kg	36	36
Piping connections	Liquid pipe	Inch (mm)	1/4(6,35)	1/4(6,35)
	Gas pipe	Inch (mm)	3/8(9,52)	3/8(9,52)
Pipe length range		m	3 – 20	3 – 20
Elevation difference (in/out) ⁷⁾		m	10	10
Pipe length for additional gas		m	7,5	7,5
Additional gas amount		g/m	10	10
Refrigerant (R32)		kg/TCO ₂ Eq.	0,83	0,86
Operating range	Heat Min – Max	°C	-25 – +24	-25 – +24
	Cool Min – Max	°C	+16 – +43	+16 – +43

Accessories

CZ-TACG1	NEW Panasonic WLAN kit for internet control
CZ-CAPRA1	RAC interface adapter for integration into P Link

Accessories

PAW-SMSCONTROL	Control by SMS (need additional SIM card)
CZ-RD514C	Wired remote controller for Wall Mounted and Floor Console

1) EER and COP calculation is based in accordance to EN14511. 2) Capacity of the heat pump is tested with powerful mode with deice mode included. 3) Energy Label Scale from A+++ to D. 4) The annual energy consumption is calculated in accordance to EU/626/2011. 5) The sound pressure of the units shows the value measured of a position 1 m in front of the main body and 0,8 m below the unit. The sound pressure is measured in accordance with Eurovent 6/C/006-97 specification. Q-Lo: Quiet mode. Lo: The lowest fan speed. 6) Add 70 mm for piping port. 7) When installing the outdoor unit at a higher position than the indoor unit.



SCOP and SEER: For CS-CZ25TKE. INTERNET CONTROL: Optional.

NEW FLOOR CONSOLE R32 GAS



New Floor Console with new nanoe™ X air-purifying system: outstanding efficiency A++, comfort (Super Quiet technology only 19 dB(A)) and healthy air combined with a breakthrough design

- New R32 refrigerant gas
- A breakthrough design that combines perfectly with the most modern environments. We have selected the best materials and processes for a refined design
- nanoe™ X with nano-technology, nano-sized electrostatic atomised water particles purify the air in the room
- High energy efficiency class A++ SEER and A++ SCOP
- Control your comfort and the power consumption with internet control
- New wireless control

 nanoe™ X



Splits 1x1

R32

CZ-TACG1
 Panasonic WLAN kit
 for internet control.

NEW Floor Console Inverter+ • R32 GAS

Maximum capacity			5,50 kW	6,20 kW
Indoor unit			CS-Z25UFEAW-1	CS-Z35UFEAW-1
Outdoor unit			CU-Z25UFEA-1	CU-Z35UFEA-1
Heating capacity	Nominal (Min - Max)	kW	3,40(0,85 - 5,50)	4,30(0,85 - 6,20)
COP ¹⁾		W/W	4,59 A	4,06 A
Heating capacity at -7 °C ²⁾		kW	3,80	4,20
COP at -7 °C ¹⁾		W/W	2,53	2,33
Heating capacity at -15 °C ²⁾		kW	3,50	3,90
COP at -15 °C ¹⁾		W/W	2,30	2,15
Heating capacity at -20 °C ²⁾		kW	2,90	3,30
COP at -20 °C ¹⁾		W/W	1,96	1,94
Heating capacity at -25 °C ²⁾		kW	2,40	2,85
COP at -25 °C ¹⁾		W/W	1,68	1,73
SCOP ³⁾		W/W	4,70 A++	4,60 A++
SCOP tested by 3rd party laboratory DTI ⁴⁾		W/W	4,79 ⁴⁾	—
Pdesign at -10 °C		kW	3,00	3,60
Input power heating	Nominal (Min - Max)	kW	0,74(0,17 - 1,51)	1,06(0,17 - 1,83)
Annual energy consumption ⁵⁾		kWh/a	894	1096
Cooling capacity	Nominal (Min - Max)	kW	2,50(0,85 - 3,40)	3,50(0,85 - 3,80)
SEER ³⁾		W/W	8,10 A++	7,80 A++
Pdesign (cooling)		kW	2,50	3,50
Input power cooling	Nominal (Min - Max)	kW	0,51(0,17 - 0,88)	0,84(0,17 - 1,04)
Annual energy consumption ⁵⁾		kWh/a	108	157
Indoor unit				
Air volume	Heat / Cool	m ³ /min	9,9/9,6	10,1/9,9
Moisture removal volume		L/h	1,5	2,0
Sound pressure ⁶⁾	Heat (Hi / Lo / Q-Lo)	dB(A)	38/25/19	39/26/19
	Cool (Hi / Lo / Q-Lo)	dB(A)	38/25/20	39/26/20
Dimension	H x W x D	mm	600 x 750 x 207	600 x 750 x 207
Net weight		kg	13	13
Outdoor unit				
Power source		V	230	230
Recommended fuse		A	10	10
Air volume	Heat / Cool	m ³ /min	32,2/32,2	34,4/32,7
Sound pressure ⁶⁾	Heat — Cool (Hi / Lo)	dB(A)	48/45 — 46/43	50/47 — 48/45
Dimension ⁷⁾	H x W x D	mm	622 x 824 x 299	622 x 824 x 299
Net weight		kg	34	37
Piping connections	Liquid pipe	Inch (mm)	1/4(6,35)	1/4(6,35)
	Gas pipe	Inch (mm)	3/8(9,52)	3/8(9,52)
Pipe length range		m	3 - 20	3 - 20
Elevation difference (in/out) ⁸⁾		m	15	15
Pipe length for additional gas		m	7,5	7,5
Additional gas amount		g/m	10	10
Refrigerant (R32)		kg/TCO ₂ Eq.	0,97/0,65475	1,07/0,72225
Operating range	Heat Min - Max	°C	-25 - +24	-25 - +24
	Cool Min - Max	°C	-15 - +43	-15 - +43
Lowest outdoor temperature tested by 3rd party laboratory ⁹⁾		°C	-35	—

Accessories

CZ-TACG1	NEW Panasonic WLAN kit for internet control
CZ-CAPRA1	RAC interface adapter for integration into P Link

Accessories

CZ-RD514C	Wired remote controller for Wall Mounted and Floor Console
------------------	--

1) EER and COP calculation is based in accordance to EN14511. 2) Capacity of the heat pump is tested with powerful mode with deice mode included. 3) Energy Label Scale from A+++ to D. 4) SCOP Tested by 3rd Party laboratory DTI under EN14825:2016. 5) The annual energy consumption is calculated in accordance to EU/626/2011. 6) The sound pressure of the units shows the value measured of a position 1 m in front of the main body and 0,8 m below the unit. The sound pressure is measured in accordance with Eurovent 6/C/006-97 specification. Q-Lo: Quiet mode. Lo: The lowest fan speed. 7) Add 70 mm for piping port. 8) When installing the outdoor unit at a higher position than the indoor unit. 9) Tested by 3rd party laboratory, DTI, according to EN14511:2013, this temperature is not guaranteed by Factory.

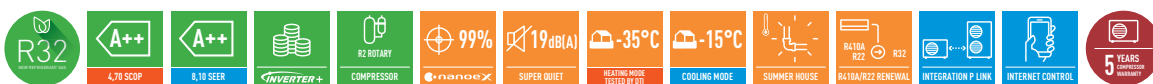

SEER and SCOP: For CS-Z25UFEAW-1. -35 °C HEATING MODE: For CS-Z25UFEAW-1 heating performance tested at -35 °C by SP, European third party laboratory. INTERNET CONTROL: Optional.

Rating Conditions: Cooling Indoor 27 °C DB / 19 °C WB. Cooling Outdoor 35 °C DB / 24 °C WB. Heating Indoor 20 °C DB. Heating Outdoor 7 °C DB / 6 °C WB. (DB: Dry Bulb; WB: Wet Bulb)
 Specifications subject to change without notice. For detailed information about ErP / Energy Labelling, please visit our websites www.aircon.panasonic.eu or www.ptc.panasonic.eu.

NEW PANASONIC COMFORT CLOUD



NEW BOUNDARIES IN CONTROL

ENERGY MONITOR AND STATISTICS

SCALABILITY AND USERS MANAGEMENT

More than a control in your phone.



Advanced smartphone control for domestic range.

Control air to air heat pump operation with Panasonic Comfort Cloud plus additional functions only available thru the Cloud from wherever and whenever. One user can manage up to 200 units and also set up different user and rights. Also energy monitor is possible giving the chance to learn how to reduce even more the operating cost.

New possibilities, new applications

- 1. Families:** Different users can be set up, such as each child can manage their own room only. In the case of second houses, this can be remotely pre-cooled or pre-warmed. Or just turned off remotely if someone forgot and left the system on.
- 2. Multi tenant owner:** Can manage different sites, up to 200 units with just one smartphone. Knowing the consumption of each place and remotely have error codes remotely for better and quick maintenance.
- 3. Small and medium sized offices:** Owner can control different rooms of the office easily and give unit by unit access to their staff. Also providing information to know where energy might be wasted for heating and cooling and promoting best comfort practices.

1 New boundaries in control

With Panasonic Comfort Cloud the user can manage all functions of the heat pump plus even more. All functions that your heat pump can include like nanoe™ air purifier, Econavi sensors, air Flow direction, speed, temperature setting, mode,... all these can be simply managed through Panasonic Comfort Cloud. Also some other additional functions can be easily managed through the app including:

- All on/off at once. For sites with more than one unit in one site, user can turn them all on or off with just one click
- Set weekly timer. Set up to 6 events per day, 42 in a week, easy, intuitive and fast
- Pre-heat or cool. Control your house or office comfort - before you arrive!
- Error code notification. If trouble occurs, error notification or maintenance code is shown



2 Energy monitor and statistics

Knowing the energy each unit uses when operating is key to see opportunities to reduce the energy bill. Panasonic Comfort Cloud stores the energy consumption* of each unit, which can then be shown in easy and powerful statistics graphs. This function is available from TKE and UKE generation.

With the weekly timer the operation can be adjusted to optimize the usage of the energy.

*Estimated energy consumption data accuracy is depending on power supply quality.



3 Scalability and users management

Easily to include additional units and locations as well as including several users with different access rights. This creates more possibilities to manage family house, a second house and also provides opportunities for small/medium sized offices or multi-tenant properties.

- Up to 200 units. Up to 10 Locations (20 units per site)
- User's control rights. Main user can set up other users with limited rights on units and set up



CZ-TACG1 Panasonic WLAN kit

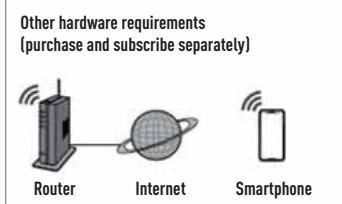
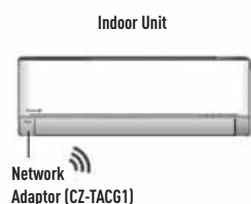

Input Voltage	DC 12V
Power Consumption	Max. 660mW
Size (H x W x D)	66 x 36 x 12mm
Mass	Approx. 85g
Interface	1 x Wireless LAN
Wireless LAN Standard	IEEE 802.11 b/g/n
Frequency Range	2,4GHz band
Encryption	AES

Compatibility: Most Panasonic Domestic range are compatible with CZ-TACG1 WLAN accessory: CS-XZ**TKEW, CS-Z**TKEW, CS-TE**TKEW, CS-TZ**TKEW, CS-FE**UKE, CS-FZ**UKE, CS-PZ**TKE, CS-UZ**TKE, CS-KE**TKE, CS-BE**TKE, CS-DE**TKE, CS-Z**TKEA, CS-Z**UFEAW, CS-Z**UB4EAW, CS-Z**UD3EAW, CS-E**SKEW, CS-XE**SKEW, CS-Z**SKEW, CS-XZ**SKEW, CS-TZ**SKEW, CS-UZ**SKE, CS-PZ**SKE. UKE generation will be also compatible. Remark: indoor temperature display and some special functions are not available through the app for all models. Languages: Available in 19 European languages: Bulgarian, Croatian, Czech, Danish, Deutsch, English, Estonian, Finnish, Francais, Greek, Hungarian, Italiano, Norwegian, Polish, Portuguese, Slovenian, Spanish, Swedish and Turkish.

CONTROL AND CONNECTIVITY

Domestic integration to P Link - CZ-CAPRA1

Can connect all ranges to P Link. Full control is now possible.

Integrates any unit in big system control:

- PKEA Server room integration
- Small offices with Domestic indoors
- Tender for refurbishment (old system Domestic and VRF in one installation)

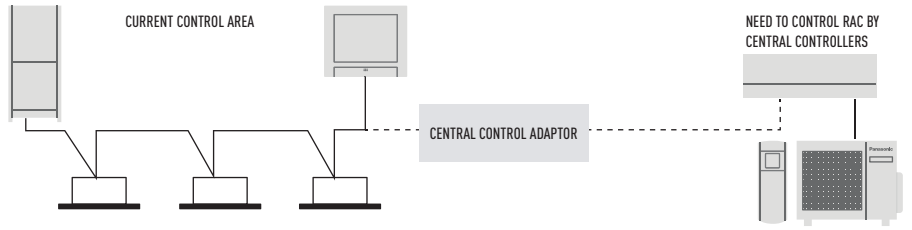

Current system for PACi / VRF. Central controller can connect to S-link line to control units directly.



RAC units cannot connect directly to S-link to be managed by Central Controllers.



It's necessary to have interface between S-link and RAC protocol to cover basic operating items.

Centralized Control Systems: 64 Indoor Units

Intelligent Controller / Web Server: 256 Indoor Units

P-AIMS: 1024 Indoor Units

Basic operation items

ON/OFF	✓
Mode select	✓
Temperature setting	✓
Fan speed	✓
Flap setting	✓
Remote control prohibit	✓
Econavi ON/OFF	✓

External input

ON/OFF control signal	✓
Abnormal stop signal	✓
External output for Relay¹	
Operation status (ON/OFF)	✓
Alarm status output	✓

¹) Because current CN-CNT connector can not provide the power for external output relay, additional Input power for external relay is necessary.

Easy connectivity



CN-CNT easy to access. Previous Etherea indoor unit had to be dismantle to reach connector.

Can easier connect:

- WLAN accessory
- KNX
- Modbus
- CZ-CAPRA1 to integrate to PACi control

ACCESSORIES & CONTROL

Optional PCB's for additional functions



CZ-TACG1
NEW Panasonic WLAN kit for internet control.



CZ-CAPRA1
RAC interface adapter for integration into P Link.



PAW-AC-KNX-1i
KNX interface for TKE and UKE models.



PAW-AC-MBS-1
Modbus interface for TKE and UKE models.



PAW-AC-ENO-1i
EnOcean interface for TKE and UKE models.



PAW-AC-BAC-1
BacNet interface for TKE and UKE models.



PAW-AC-DIO
PCB for wall mounted with dry contacts, On/Off, Error message (all UKE and RKE wall mounted).



PAW-AC-HEAT-1
Heating only PCB for Etherea, 4 Way 60x60 Cassette and Hide Away.



PAW-SMSCONTROL
Control of the Etherea, Flagship and Heatcharge by SMS (need additional SIM card).

Individual Controls



CZ-RD514C
Wired remote controller for Wall Mounted and Floor Console.

Pipe reducer



CZ-MA1P
Is to be used to reduce the connection size on the indoor unit from 1/2" to 3/8".



CZ-MA3P
Is to be used to reduce the connection size on the indoor unit from 5/8" to 1/2".

CZ-MA2P
Is to be used to increase the connection size on the outdoor unit from 3/8" to 1/2".

PANASONIC COMMERCIAL AIR TO AIR

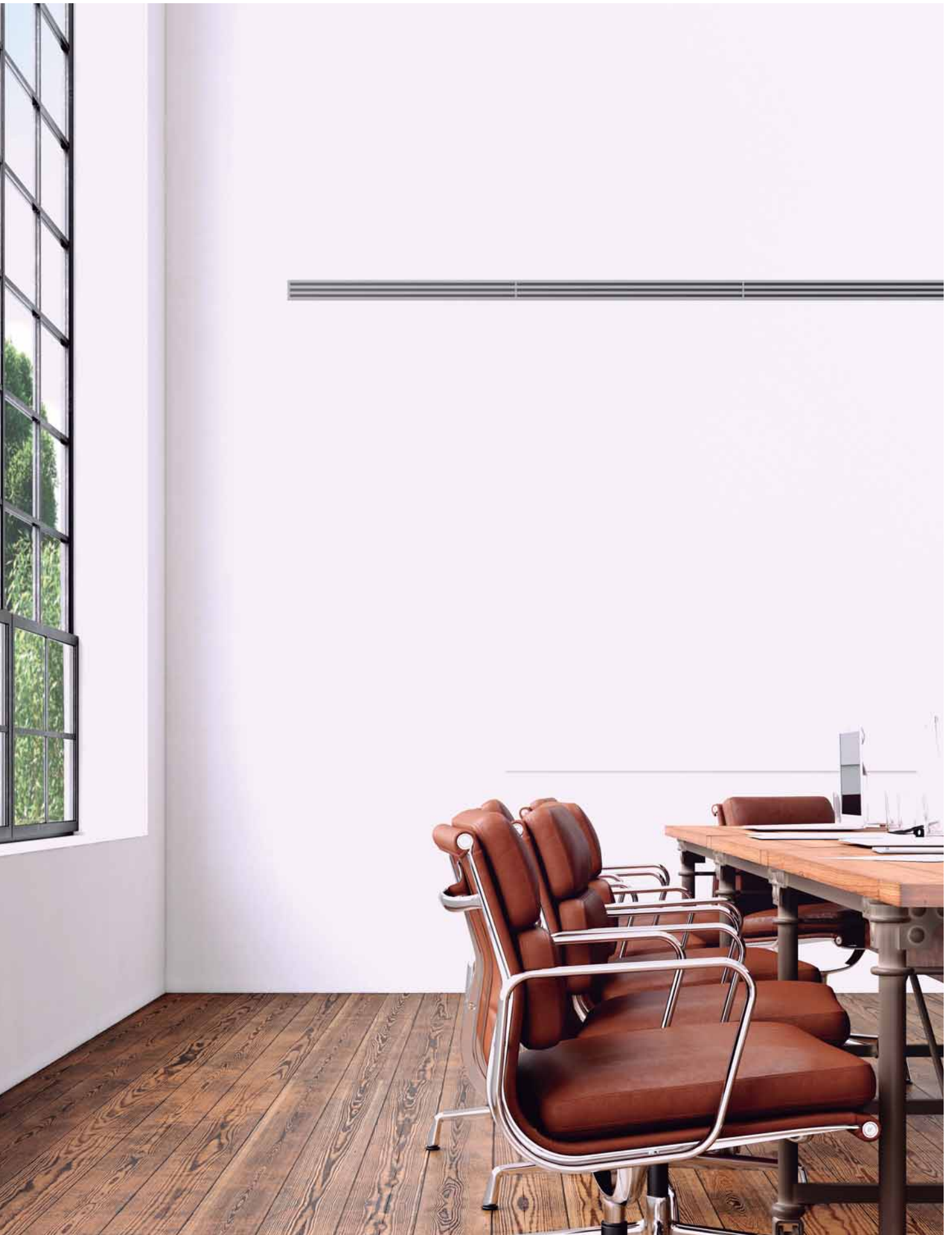

Here are some of your new air conditioner's major features. Panasonic has developed an impressive range of highly efficient Commercial Air Conditioners. This range confirms our commitment to the environment. Our Inverter compressors optimise performance.

PACi

nanoe™ X purifies air with PACi 90x90 Cassette.

Thanks to advances in design and technology such as the new high performance turbo fan, which is more efficient and silent, the nanoe™ X air cleaner which provides healthy air, the floor temperature & humidity sensor that give more control, the new PU2 Panasonic 90 x 90 4 way Cassette provides a high-class solution for energy savings, healthy environment and comfort.



Panasonic PACi R32.

New R32 PACi range helps to find more environmental friendly solutions in commercial applications. This pure refrigerant also increase the efficiency of the system.

New wall design wall type PK2 Series.

Commercial air conditioning and aesthetics find a new ally in with new PK2 series. Following same shape as design award Etherea, PK2 series will combine with any indoor design.



Server room solutions.

Choose the best solution to ensure any server room needs. Designed for high durability and adverse weather conditions its server room ad hoc control ensure permanent operation and failure alarms communications.

New control CZ-RTC5B with datanavi.

Ready to control 2 PACi systems with backup and alternate operation.

Complete AHU Solution.

Demand control 0-10V, box IP65 case, cold draft prevention, monitoring status digital output, remote control built-in.

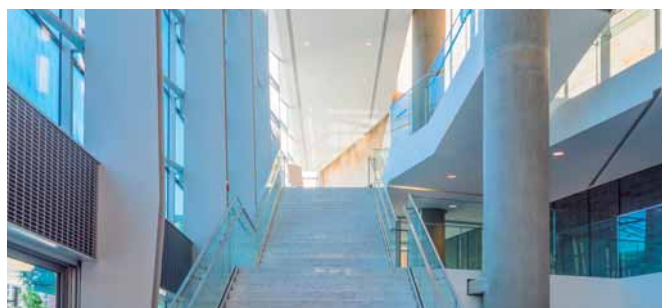

INNOVATIVE SOLUTIONS FOR RETAIL

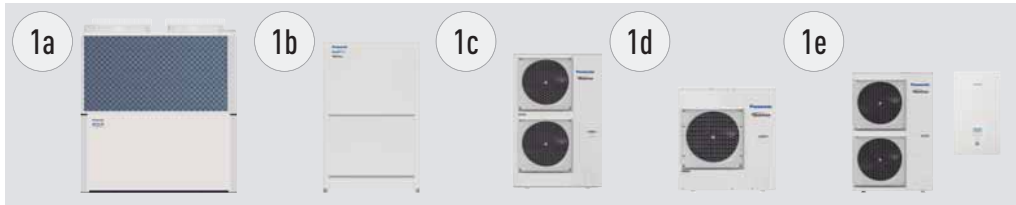

Multi energy solutions, gas or electric.

The Multi energy solution (Gas and Electric) from Panasonic gives the best of the energy saving and on the flexibility of the installation. Panasonic solutions can be connect to direct expansion systems, water chiller installations and ventilation systems as air handling units.

- 1a: Gas VRF. ECO G
- 1b: Electric VRF. ECOi
- 1c: Electric VRF. Mini ECOi
- 1d: Electric 1x1. PACi
- 1e: Electric A2W. Aquarea



TKEA outdoor unit for server room.

Steady cooling, nonstop, even at -20 °C and still with high efficiency. Ready for continuous operation and easy to connect 2 systems to automatically alternate and ensure server rooms are kept cool with maximum operating guaranteed.



Control your way.

Wide variety of controls, from simple user control to full system control via remote access functionality. Touch panel, web server, consumption control, smartphone control... everything is possible.

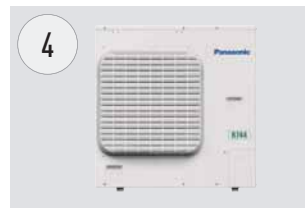

Panasonic 4 kW Condensing unit with natural refrigerant.

Panasonic now offers a reliable and environmentally friendly condensing unit for commercial refrigeration. This 4 kW condensing unit is suitable for refrigeration and freezer applications in gas stations and convenient stores.



Wide range of indoor units.

Complete range of indoor units that fits any need. All units provided with supply air temperature sensor and low operation sound level to guarantee guests comfort. From 1,50 kW up to 30 kW.

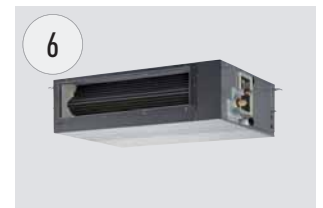

Hide Away, for power and efficiency.

Super silent units deliver the ideal air supply. Units available from 1,50 kW providing precise temperature control even in small rooms. Two models available: slim unit for height restricted areas (MM unit only 200 mm deep), another which allows 100 % fresh air (MF).



Air Curtain with DX Coil.

The Panasonic range of air curtains is designed for smooth operation and efficient performance.



Protocol friendly.

Great flexibility for integration into your KNX / Modbus / LonWorks / BACnet projects allows fully bi-directional monitoring and control of all the functioning parameters. Range of solutions to control locally or remotely the full system in bi-directional mode.



Air Handling Unit kits for efficient ventilation.

The new AHU kit is specially designed to improve the efficiency of the pre-heating or pre-cooling process of the ventilation.

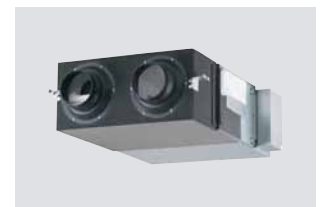

Energy Recovery unit for high efficiency of the system.

Panasonic Energy Recovery Ventilators can reduce the outside air load because they efficiently recover the heat lost by ventilation during the heat recovery process.

Heating and cooling solutions for retail applications

Panasonic has developed solutions for retail applications and office applications where return on investment is a key factor! The comfort inside the shop is key for a good customer experience in the shop. From local control or from Panasonic new cloud control system, a detail status of the heating and cooling system can be displayed, analysed and optimised in order to improve the efficiency, reduce the running time and increase the life time of the units.

8 reason why Panasonic is the best solution for your Retail:

- Complete solution
- Flexibility and adaptation
- Go green retail: low CO₂ emissions
- Comfort - high customer satisfaction
- Future expansion
- Panasonic offers efficient systems meeting expectations over the years
- High quality of service with Panasonic pro-partner installation team
- The system will still operate up to 25 % of the connected indoor units. System will not stop when up to 25 % of indoor units have power supply breakdown when they are on mode

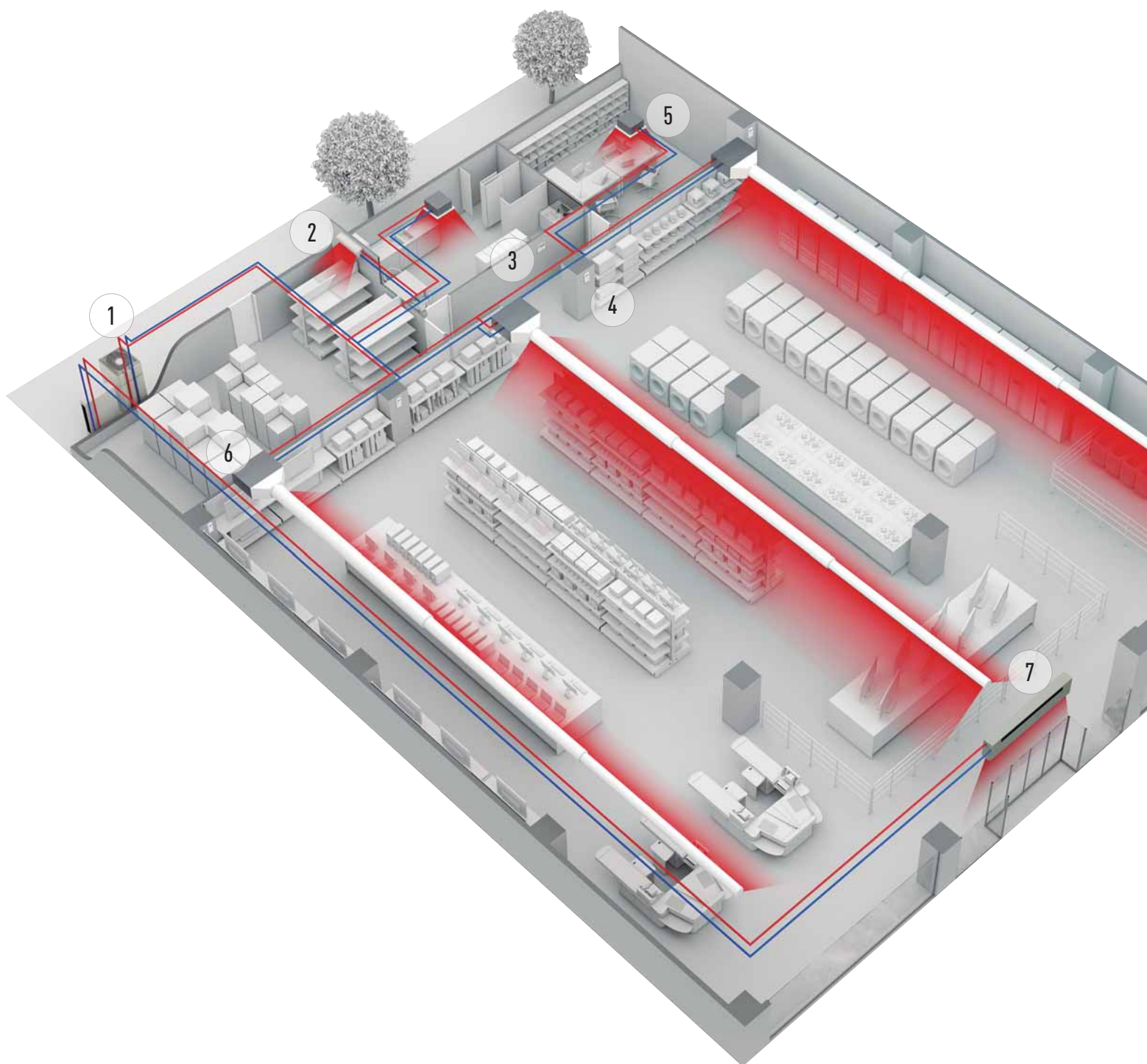

FREE MULTI SYSTEM



**UP TO 5
INDOOR UNITS
WITH A SINGLE
OUTDOOR UNIT**

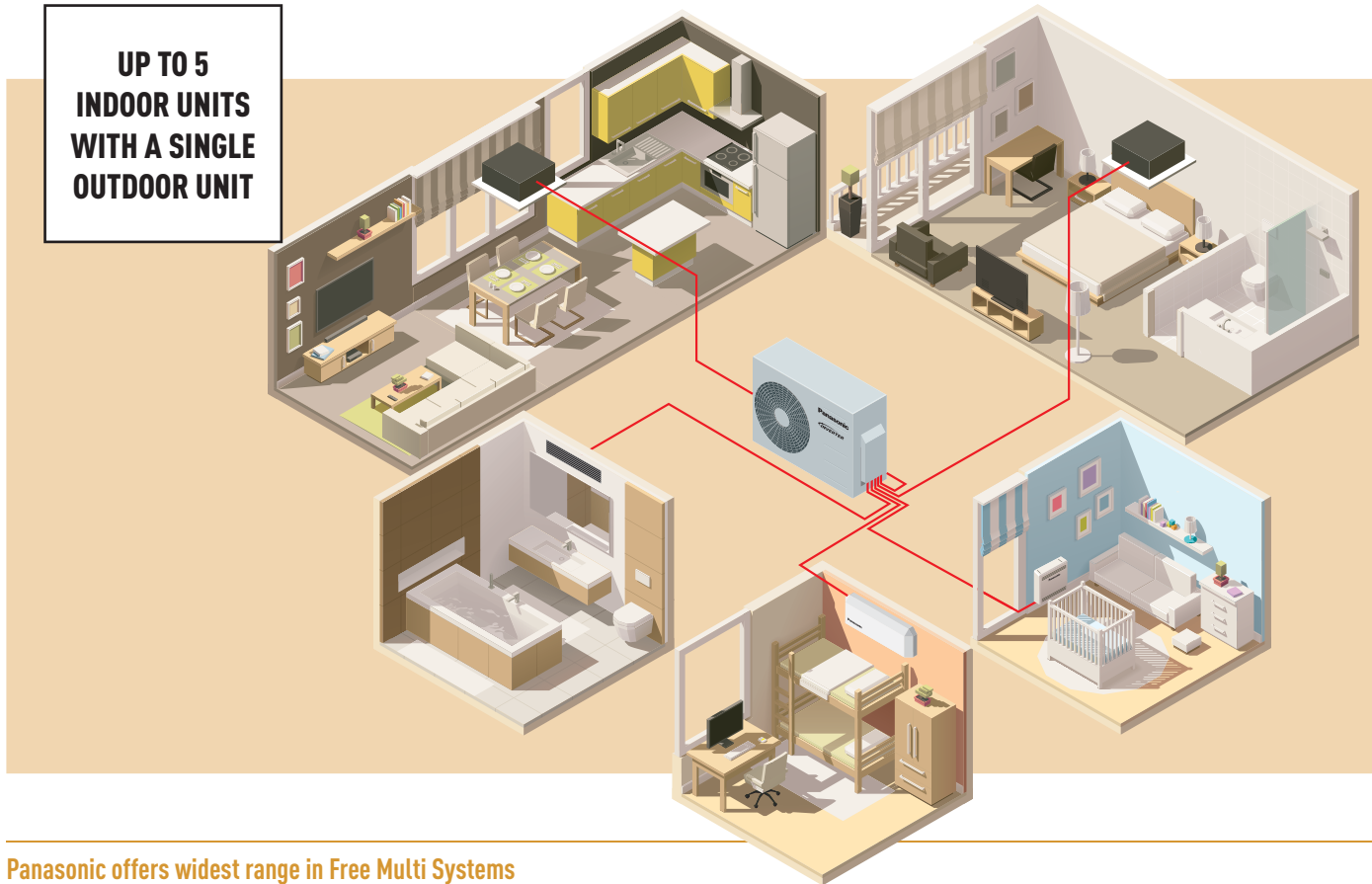

Panasonic offers widest range in Free Multi Systems

Free Multi System range from 3,50 to 9,00 kW for 5 indoor units with one outdoor unit.

Free Multi Z

Full flexibility up to 9,00 kW and up to 5 ports with wide range of indoor units including high performance Etherea indoor units, reaching up to A+++ / A++

Why a Free Multi System is better than several separate split units

Up to 5 indoor units with a single outdoor unit.

- Just one compact outdoor unit
- Increased comfort in the house since every room has its own indoor unit for heating

- Much more powerful than a single split
- More efficient since the units are always operating at full capacity
- You can connect all types of indoor units, such as wall types and consoles, depending on what suits your house best

Solution with single split.

One indoor unit is connected to one outdoor unit. The indoor unit is placed in the main hallway and heats the entire house. Certain rooms may not be perfectly heated, which causes inadequate comfort.

Solution with Free Multi System.

With one outdoor unit, you can connect up to five indoor units. There is one indoor unit per room or area. It gives an extreme increase in comfort levels. On the roof, there is only one outdoor unit.

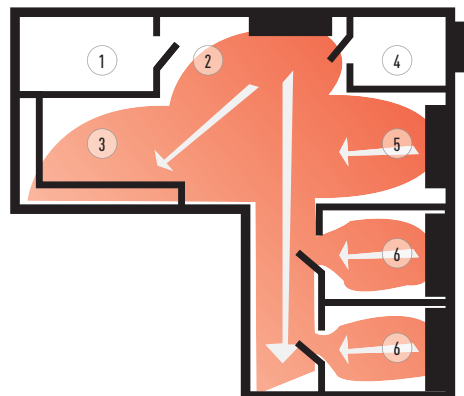
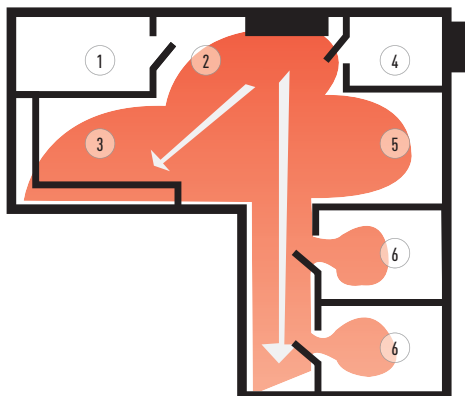

1. Laundry room

2. Entrance

3. Kitchen/dining area

4. Bathroom

5. Living room

6. Bedroom

R32 **Free Multi System Z**



Outdoor unit Free Multi System Z • R32 GAS

System Capacity (Min - Max Indoor Cooling Capacity Nominal)			3,20 - 6,00 kW	3,20 - 6,00 kW	3,20 - 7,70 kW	4,50 - 9,50 kW	4,50 - 11,20 kW	4,50 - 11,50 kW	4,50 - 14,70 kW	4,50 - 18,30 kW
Unit			CU-2Z35TBE	CU-2Z41TBE	CU-2Z50TBE	CU-3Z52TBE	CU-3Z68TBE	CU-4Z68TBE	CU-4Z80TBE	CU-5Z90TBE
Cooling capacity	Nominal (Min - Max)	kW	3,50(1,50-4,50)	4,10(1,50-5,20)	5,00(1,50-5,40)	5,20(1,80-7,30)	6,80(1,90-8,00)	6,80(1,90-8,80)	8,00(3,00-9,20)	9,00(2,90-11,50)
EER ¹⁾	Nominal (Min - Max)	W/W	4,86(6,00-4,09)A	4,56(6,00-3,80)A	4,24(6,00-3,62)A	4,77 A	3,66(7,04-3,38)A	4,39(5,59-3,56)A	4,04(5,66-3,21)A	4,09(5,27-2,98)A
SEER ²⁾		W/W	8,50 A+++	8,50 A+++	8,50 A+++	8,50 A+++	8,00 A++	8,00 A++	7,90 A++	8,50 A+++
Pdesign (cooling)		kW	3,5	4,1	5,0	5,2	6,8	6,8	8,0	9,0
Input power cooling	Nominal (Min - Max)	kW	0,72(0,25-1,10)	0,90(0,25-1,37)	1,18(0,25-1,49)	1,09(0,36-2,18)	1,86(0,27-2,37)	1,55(0,34-2,47)	1,98(0,53-2,87)	2,20(0,55-3,86)
Annual energy consumption ³⁾		kWh/a	144	169	206	214	298	298	990	1100
Heating capacity	Nominal (Min - Max)	kW	4,20(1,10-5,60)	4,60(1,10-7,00)	5,60(1,10-7,20)	6,80(1,60-8,30)	8,50(3,30-10,40)	8,50(3,00-10,60)	9,40(2,40-10,60)	10,40(3,40-14,50)
Heating capacity at -7 °C		kW	—	—	—	3,95	4,45	4,45	—	—
COP ¹⁾	Nominal (Min - Max)	W/W	4,88(5,24-4,18)A	4,79(5,24-3,91)A	4,63(5,24-4,00)A	4,63(5,00-3,82)A	3,95(5,32-3,64)A	4,47(5,17-3,96)A	4,63(6,00-3,46)A	4,84(6,42-3,42)A
SCOP ²⁾		W/W	4,60 A++	4,60 A++	4,60 A++	4,20 A+	4,20 A+	4,20 A+	4,70 A++	4,68 A+++
Pdesign at -10 °C		kW	3,2	3,5	4,2	5,0	5,2	5,8	6,8	8,5
Input power heating	Nominal (Min - Max)	kW	0,86(0,21-1,34)	0,96(0,21-1,79)	1,21(0,21-1,80)	1,47(0,32-2,17)	2,15(0,62-2,86)	1,90(0,58-2,68)	2,03(0,70-3,06)	2,15(0,53-4,24)
Annual energy consumption ³⁾		kWh/a	974	1065	1278	1667	1733	1933	2026	2543
Current	Cool / Heat	A	3,35/4,00	4,15/4,45	5,35/5,50	5,00/6,70	8,40/9,70	7,00/8,60	9,50/9,50	10,50/10,10
Power source		V	230	230	230	230	230	230	230	230
Recommended fuse		A	16	16	16	16	16	20	20	25
Recommended power cable section		mm ²	2,5	2,5	2,5	2,5	2,5	2,5	2,5	3,5
Sound pressure ⁴⁾	Cool / Heat (Hi)	dB(A)	48/50	48/50	50/52	47/48	51/52	49/50	51/52	53/54
Dimension ⁵⁾	H x W x D	mm	619 x 824 x 299	619 x 824 x 299	619 x 824 x 299	795 x 875 x 320	795 x 875 x 320	795 x 875 x 320	999 x 940 x 340	999 x 940 x 340
Net weight		kg	39	39	39	71	71	72	80	81
Piping connections	Liquid pipe	Inch (mm)	1/4(6,35)	1/4(6,35)	1/4(6,35)	1/4(6,35)	1/4(6,35)	1/4(6,35)	1/4(6,35)	1/4(6,35)
	Gas pipe	Inch (mm)	3/8(9,52)	3/8(9,52)	3/8(9,52)	3/8(9,52)	3/8(9,52)	3/8(9,52)	3/8(9,52)	3/8(9,52)
Pipe length range total ⁶⁾		m	6-30	6-30	6-30	6-50	6-60	6-60	6-70	6-80
Pipe length range to one unit		m	3-20	3-20	3-20	3-25	3-25	3-25	3-25	3-25
Elevation difference (in/out)		m	10	10	10	15	15	15	15	15
Pipe length for additional gas		m	20	20	20	30	30	30	45	45
Additional gas amount		g/m	15	15	15	20	20	20	20	20
Refrigerant (R32)		kg/TCO ₂ Eq.	1,12/0,756	1,12/0,756	1,12/0,756	2,10/1,418	2,10/1,418	2,10/1,418	2,72/1,836	2,72/1,836
Operating range	Cool Min ~ Max	°C	-10 ~ +46	-10 ~ +46	-10 ~ +46	-10 ~ +46	-10 ~ +46	-10 ~ +46	-10 ~ +46	-10 ~ +46
	Heat Min ~ Max	°C	-15 ~ +24	-15 ~ +24	-15 ~ +24	-15 ~ +24	-15 ~ +24	-15 ~ +24	-15 ~ +24	-15 ~ +24

1) EER and COP calculation is based in accordance to EN14511. 2) Energy Label Scale from A+++ to D. 3) The annual energy consumption is calculated in accordance to EU/626/2011. 4) The sound pressure of the units shows the value measured of a position 1 m in front of the main body and 0,8 m below the unit. The sound pressure is measured in accordance with Eurovent 6/C/006-97 specification. 5) Add 70 or 95mm for piping port. 6) Minimum piping length is 3 meters per indoor unit. Minimum quantity of connection: 2 indoor units.

Possible outdoor / indoor units combinations • R32 GAS

	Wall Mounted TZ Compact Style						NEW Floor Console*						NEW 4 Way 60x60 Cassette						NEW Low Static Pressure Hide Away													
	16	20	25	35	42	50	60	71	16	20	25	35	42	50	60	71	16	20	25	35	42	50	60	71	16	20	25	35	42	50	60	71
CU-2Z35TBE // 3,20 - 6,00 kW // 2 Rooms	✓	✓	✓	✓	✓	✓	✓	✓	✓	✓	✓	✓	✓	✓	✓	✓	✓	✓	✓	✓	✓	✓	✓	✓	✓	✓	✓	✓	✓	✓	✓	✓
CU-2Z41TBE // 3,20 - 6,00 kW // 2 Rooms	✓	✓	✓	✓	✓	✓	✓	✓	✓	✓	✓	✓	✓	✓	✓	✓	✓	✓	✓	✓	✓	✓	✓	✓	✓	✓	✓	✓	✓	✓	✓	✓
CU-2Z50TBE // 3,20 - 7,70 kW // 2 Rooms	✓	✓	✓	✓	✓	✓	✓	✓	✓	✓	✓	✓	✓	✓	✓	✓	✓	✓	✓	✓	✓	✓	✓	✓	✓	✓	✓	✓	✓	✓	✓	✓
CU-3Z52TBE // 4,50 - 9,50 kW // 3 Rooms	✓	✓	✓	✓	✓	✓	✓	✓	✓	✓	✓	✓	✓	✓	✓	✓	✓	✓	✓	✓	✓	✓	✓	✓	✓	✓	✓	✓	✓	✓	✓	✓
CU-3Z68TBE // 4,50 - 11,20 kW // 3 Rooms	✓	✓	✓	✓	✓	✓	✓	✓	✓	✓	✓	✓	✓	✓	✓	✓	✓	✓	✓	✓	✓	✓	✓	✓	✓	✓	✓	✓	✓	✓	✓	✓
CU-4Z68TBE // 4,50 - 11,50 kW // 4 Rooms	✓	✓	✓	✓	✓	✓	✓	✓	✓	✓	✓	✓	✓	✓	✓	✓	✓	✓	✓	✓	✓	✓	✓	✓	✓	✓	✓	✓	✓	✓	✓	✓
CU-4Z80TBE // 4,50 - 14,70 kW // 4 Rooms	✓	✓	✓	✓	✓	✓	✓	✓	✓	✓	✓	✓	✓	✓	✓	✓	✓	✓	✓	✓	✓	✓	✓	✓	✓	✓	✓	✓	✓	✓	✓	✓
CU-5Z90TBE // 4,50 - 18,30 kW // 5 Rooms	✓	✓	✓	✓	✓	✓	✓	✓	✓	✓	✓	✓	✓	✓	✓	✓	✓	✓	✓	✓	✓	✓	✓	✓	✓	✓	✓	✓	✓	✓	✓	✓

1) A CZ-MA1P pipe reducer is needed on the 42 and 50, a CZ-MA2P pipe expander is needed on the 60 and 71, and CZ-MA3P pipe reducer on the 71. * Compatible only with 2 ports outdoor CU-2Z35TBE / CU-2Z41TBE / CU-2Z50TBE.

Outdoor Multi combination model

	Model
CS-MTZ16TKE CS-TZ20TKEW-1 / CS-MZ20UB4EA / CS-MZ20UD3EA CS-TZ25TKEW-1 / CS-Z25UFEAW-1 / CS-Z25UB4EAW / CS-Z25UD3EAW CS-TZ35TKEW-1 / CS-Z35UFEAW-1 / CS-Z35UB4EAW / CS-Z35UD3EAW	CU-2Z35TBE / CU-2Z41TBE / CU-2Z50TBE / CU-3Z52TBE / CU-3Z68TBE / CU-4Z68TBE / CU-4Z80TBE / CU-5Z90TBE
CS-TZ42TKEW-1 CS-TZ50TKEW / CS-Z50UB4EAW / CS-Z50UD3EAW	CU-2Z50TBE / CU-3Z52TBE / CU-3Z68TBE / CU-4Z68TBE / CU-4Z80TBE / CU-5Z90TBE
CS-TZ60TKEW / CS-Z60UB4EAW / CS-Z60UD3EAW	CU-3Z68TBE / CU-4Z68TBE / CU-4Z80TBE / CU-5Z90TBE
CS-TZ71TKEW	CU-4Z80TBE / CU-5Z90TBE

* For CZ-MA3P necessary to use adaptor CZ-MA2P too.

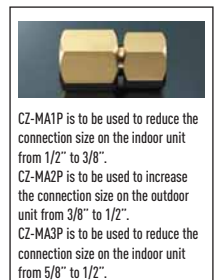

CZ-MA1P is to be used to reduce the connection size on the indoor unit from 1/2" to 3/8".
CZ-MA2P is to be used to increase the connection size on the outdoor unit from 3/8" to 1/2".
CZ-MA3P is to be used to reduce the connection size on the indoor unit from 5/8" to 1/2".

Free Multi System Z

R32



Wall Mounted TZ Compact Style	Indoor unit	Cooling capacity kW / kCal/h	Heating capacity kW / kCal/h	Connection in. / out. mm ²⁾	Sound pressure ¹⁾		Dimension / Net weight		Piping connections	
					Cool — Heat (Hi/L0/S-Lo)		HxWxD		Liquid / Gas pipe	
					dB(A)		mm / kg		Inch (mm)	
1,60 kW	CS-MTZ16TKE	1,60/1380	2,60/2240	4 x 1,5	38/27/22 — 39/28/24		290 x 799 x 197/8		1/4 (6,35) / 3/8 (9,52)	
2,00 kW	CS-TZ20TKEW-1	2,00/1720	3,20/2750	4 x 1,5	39/27/22 — 40/28/24		290 x 799 x 197/8		1/4 (6,35) / 3/8 (9,52)	
2,50 kW	CS-TZ25TKEW-1	2,50/2150	3,60/3100	4 x 1,5	42/28/22 — 42/29/24		290 x 799 x 197/8		1/4 (6,35) / 3/8 (9,52)	
3,50 kW ²⁾	CS-TZ35TKEW-1	3,50/3010	4,50/3870	4 x 1,5	44/32/22 — 44/35/24		290 x 799 x 197/8		1/4 (6,35) / 3/8 (9,52)	
4,20 kW	CS-TZ42TKEW-1	4,20/3610	5,00/4300	4 x 1,5	44/33/31 — 46/37/30		290 x 799 x 197/8		1/4 (6,35) / 3/8 (9,52)	
5,00 kW	CS-TZ50TKEW	5,00/4300	5,30/4558	4 x 1,5	44/39/36 — 46/39/36		302 x 1102 x 244/12		1/4 (6,35) / 3/8 (9,52)	
6,00 kW	CS-TZ60TKEW	6,00/5160	8,50/7310	4 x 1,5	44/39/36 — 47/39/36		302 x 1102 x 244/12		1/4 (6,35) / 1/2 (12,70)	
7,10 kW	CS-TZ71TKEW	7,10/6110	8,70/7482	4 x 1,5	49/40/37 — 49/40/37		302 x 1102 x 244/13		1/4 (6,35) / 1/2 (12,70)	



NEW Floor Console 31*	Indoor	Cooling capacity kW / kCal/h	Heating capacity kW / kCal/h	Connection in. / out. mm ²⁾	Sound pressure ¹⁾		Dimension / Net weight		Piping connections	
					Cool — Heat (Hi/L0/S-Lo)		HxWxD		Liquid / Gas pipe	
					dB(A)		mm / kg		Inch (mm)	
2,50 kW	CS-Z25UFEAW-1	2,50/2410	3,40/3100	4 x 1,5	38/25/20 — 38/25/19		600 x 750 x 207/13		1/4 (6,35) / 3/8 (9,52)	
3,50 kW ²⁾	CS-Z35UFEAW-1	3,50/3010	4,30/3870	4 x 1,5	39/26/20 — 39/26/19		600 x 750 x 207/13		1/4 (6,35) / 3/8 (9,52)	



NEW CZ-BT20EW RAL9010 panel for 4 Way 60x60 Cassette (sold separately)



NEW 4 Way 60x60 Cassette*	Indoor (Panel CZ-BT20EW)	Cooling capacity kW / kCal/h	Heating capacity kW / kCal/h	Connection in. / out. mm ²⁾	Sound pressure ¹⁾		Dimension / Net weight		Piping connections	
					Cool — Heat (Hi/L0/S-Lo)		Indoor HxWxD		Liquid / Gas pipe	
					dB(A)		mm / kg		Inch (mm)	
2,00 kW	CS-MZ20UB4EA	2,00/1720	3,20/2750	4 x 1,5	35/27/24 — 36/30/27		260 x 575 x 575/18 51 x 700 x 700/2,5		1/4 (6,35) / 3/8 (9,52)	
2,50 kW	CS-Z25UB4EAW	2,50/2150	3,60/3100	4 x 1,5	36/27/24 — 37/30/27		260 x 575 x 575/18 51 x 700 x 700/2,5		1/4 (6,35) / 3/8 (9,52)	
3,50 kW ²⁾	CS-Z35UB4EAW	3,50/3010	4,50/3870	4 x 1,5	36/28/25 — 37/30/27		260 x 575 x 575/18 51 x 700 x 700/2,5		1/4 (6,35) / 3/8 (9,52)	
5,00 kW ⁴⁾	CS-Z50UB4EAW	5,00/4300	6,80/5850	4 x 1,5	39/30/27 — 40/31/28		260 x 575 x 575/18 51 x 700 x 700/2,5		1/4 (6,35) / 3/8 (9,52)	
6,00 kW	CS-Z60UB4EAW	6,00/5160	8,50/7310	4 x 1,5	44/34/31 — 45/34/31		260 x 575 x 575/18 51 x 700 x 700/2,5		1/4 (6,35) / 1/2 (12,70)	



NEW Low Static Pressure Hide Away*	Indoor	Cooling capacity kW / kCal/h	Heating capacity kW / kCal/h	Connection in. / out. mm ²⁾	Sound pressure ¹⁾		Dimension / Net weight		Piping connections	
					Cool — Heat (Hi/L0/S-Lo)		HxWxD		Liquid / Gas pipe	
					dB(A)		mm / kg		Inch (mm)	
2,00 kW	CS-MZ20UD3EA	2,00/1720	3,20/2750	4 x 1,5	34/29/26 — 36/29/26		200 x 750 x 640/19		1/4 (6,35) / 3/8 (9,52)	
2,50 kW	CS-Z25UD3EAW	2,50/2150	3,60/3100	4 x 1,5	35/29/26 — 37/29/26		200 x 750 x 640/19		1/4 (6,35) / 3/8 (9,52)	
3,50 kW ²⁾	CS-Z35UD3EAW	3,50/3010	4,50/3870	4 x 1,5	35/29/26 — 37/29/26		200 x 750 x 640/19		1/4 (6,35) / 3/8 (9,52)	
5,00 kW ⁴⁾	CS-Z50UD3EAW	5,00/4300	6,80/5850	4 x 1,5	41/31/28 — 41/32/29		200 x 750 x 640/19		1/4 (6,35) / 3/8 (9,52)	
6,00 kW	CS-Z60UD3EAW	6,00/5160	8,50/7310	4 x 1,5	43/32/29 — 43/34/31		200 x 750 x 640/19		1/4 (6,35) / 1/2 (12,70)	

1) The sound pressure of the units shows the value measured of a position 1m in front of the main body. The sound pressure is measured in accordance with Eurovent 6/C/006-97 specification. 2) The heating capacity is 4,20kW connected to a CU-Z255TBE. 3) Compatible only with 2 ports Outdoor CU-Z235TBE / CU-Z241TBE / CU-Z250TBE. 4) The heating capacity is 5,30kW connected to a CU-Z250TBE. * Tentative data.

FREE MULTI R32 COMBINATIONS TABLE

Free Multi 2x1 CU-2Z35TBE. Minimum capacity connected: 3,20 kW. Maximum capacity connected: 6,00 kW • R32 GAS

Indoor unit capacity	Cooling capacity (kW) Rooms					EER	SEER ¹	Input power rating			A.E.C.	Current	Heating capacity (kW) Rooms				COP	SCOP ¹	Input power rating			A.E.C.	Current		
	A	B	Total (Min - Max)	W/W	W/W			kW	kWh	230V			A	B	Total (Min - Max)	W/W			W/W	kW	kWh			230V	
1 Room																									
16	1,60		1,60(1,10 - 2,30)	3,90	A		0,41(0,22 - 0,60)	205	1,95	2,60		2,60(0,70 - 3,80)	3,77	A		0,69(0,17 - 1,11)	345	3,20							
20	2,00		2,00(1,10 - 2,90)	3,85	A		0,52(0,22 - 0,77)	260	2,45	3,20		3,20(0,70 - 4,80)	3,76	A		0,85(0,17 - 1,41)	425	3,95							
25	2,50		2,50(1,10 - 3,50)	3,73	A		0,67(0,22 - 1,00)	335	3,15	3,60		3,60(0,70 - 5,50)	3,50	B		1,03(0,17 - 1,70)	515	4,75							
35	3,50		3,50(1,10 - 4,00)	3,47	A		1,01(0,22 - 1,22)	505	4,70	4,20		4,20(0,70 - 5,60)	3,44	B		1,22(0,17 - 1,68)	610	5,65							
2 Rooms																									
16+16	1,60	1,60	3,20(1,50 - 4,00)	4,92	A	8,50	A+++	0,65(0,25 - 1,00)	325	3,05	2,10	2,10	4,20(1,10 - 5,60)	4,88	A	4,60	A++	0,86(0,21 - 1,34)	430	4,00					
16+20	1,55	1,95	3,50(1,50 - 4,50)	4,86	A	8,50	A+++	0,72(0,25 - 1,10)	360	3,35	1,85	2,35	4,20(1,10 - 5,60)	4,88	A	4,60	A++	0,86(0,21 - 1,34)	430	4,00					
16+25	1,35	2,15	3,50(1,50 - 4,50)	4,86	A	8,50	A+++	0,72(0,25 - 1,10)	360	3,35	1,65	2,55	4,20(1,10 - 5,60)	4,88	A	4,60	A++	0,86(0,21 - 1,34)	430	4,00					
16+35	1,10	2,40	3,50(1,50 - 4,50)	4,86	A	8,50	A+++	0,72(0,25 - 1,10)	360	3,35	1,30	2,90	4,20(1,10 - 5,60)	4,88	A	4,60	A++	0,86(0,21 - 1,34)	430	4,00					
20+20	1,75	1,75	3,50(1,50 - 4,50)	4,86	A	8,50	A+++	0,72(0,25 - 1,10)	360	3,35	2,10	2,10	4,20(1,10 - 5,60)	4,88	A	4,60	A++	0,86(0,21 - 1,34)	430	4,00					
20+25	1,55	1,95	3,50(1,50 - 4,50)	4,86	A	8,50	A+++	0,72(0,25 - 1,10)	360	3,35	1,85	2,35	4,20(1,10 - 5,60)	4,88	A	4,60	A++	0,86(0,21 - 1,34)	430	4,00					
20+35	1,25	2,25	3,50(1,50 - 4,50)	5,07	A	8,50	A+++	0,69(0,25 - 1,05)	345	3,25	1,55	2,65	4,20(1,10 - 5,60)	5,00	A	4,60	A++	0,84(0,21 - 1,29)	420	3,90					
25+25	1,75	1,75	3,50(1,50 - 4,50)	5,07	A	8,50	A+++	0,69(0,25 - 1,05)	345	3,25	2,10	2,10	4,20(1,10 - 5,60)	5,00	A	4,60	A++	0,84(0,21 - 1,29)	420	3,90					
25+35	1,45	2,05	3,50(1,50 - 4,50)	5,07	A	8,50	A+++	0,69(0,25 - 1,05)	345	3,25	1,75	2,45	4,20(1,10 - 5,60)	5,00	A	4,60	A++	0,84(0,21 - 1,29)	420	3,90					

Free Multi 2x1 CU-2Z41TBE. Minimum capacity connected: 3,20 kW. Maximum capacity connected: 6,00 kW • R32 GAS

Indoor unit capacity	Cooling capacity (kW) Rooms					EER	SEER ¹	Input power rating			A.E.C.	Current	Heating capacity (kW) Rooms				COP	SCOP ¹	Input power rating			A.E.C.	Current		
	A	B	Total (Min - Max)	W/W	W/W			kW	kWh	230V			A	B	Total (Min - Max)	W/W			W/W	kW	kWh			230V	
1 Room																									
16	1,60		1,60(1,10 - 2,30)	3,90	A		0,41(0,22 - 0,60)	205	1,95	2,60		2,60(0,70 - 3,80)	3,77	A		0,69(0,17 - 1,11)	345	3,20							
20	2,00		2,00(1,10 - 2,90)	3,85	A		0,52(0,22 - 0,77)	260	2,45	3,20		3,20(0,70 - 4,80)	3,76	A		0,85(0,17 - 1,41)	425	3,95							
25	2,50		2,50(1,10 - 3,50)	3,73	A		0,67(0,22 - 1,00)	335	3,15	3,60		3,60(0,70 - 5,50)	3,50	B		1,03(0,17 - 1,70)	515	4,75							
35	3,50		3,50(1,10 - 4,00)	3,47	A		1,01(0,22 - 1,22)	505	4,70	4,50		4,50(0,70 - 6,20)	3,60	B		1,25(0,17 - 1,81)	625	5,80							
2 Rooms																									
16+16	1,60	1,60	3,20(1,50 - 4,00)	4,71	A	8,50	A+++	0,68(0,25 - 0,99)	340	3,15	2,20	2,20	4,40(1,10 - 7,00)	4,68	A	4,60	A++	0,94(0,21 - 1,81)	470	4,35					
16+20	1,60	2,00	3,60(1,50 - 4,50)	4,62	A	8,50	A+++	0,78(0,25 - 1,15)	390	3,60	2,05	2,55	4,60(1,10 - 7,00)	4,79	A	4,60	A++	0,96(0,21 - 1,79)	480	4,45					
16+25	1,60	2,50	4,10(1,50 - 5,20)	4,56	A	8,50	A+++	0,90(0,25 - 1,37)	450	4,15	1,80	2,80	4,60(1,10 - 7,00)	4,79	A	4,60	A++	0,96(0,21 - 1,79)	480	4,45					
16+35	1,30	2,80	4,10(1,50 - 5,20)	4,56	A	8,50	A+++	0,90(0,25 - 1,37)	450	4,15	1,45	3,15	4,60(1,10 - 7,00)	4,79	A	4,60	A++	0,96(0,21 - 1,79)	480	4,45					
20+20	2,00	2,00	4,00(1,50 - 5,00)	4,49	A	8,50	A+++	0,89(0,25 - 1,31)	445	4,10	2,30	2,30	4,60(1,10 - 7,00)	4,84	A	4,60	A++	0,95(0,21 - 1,77)	475	4,40					
20+25	1,80	2,30	4,10(1,50 - 5,20)	4,56	A	8,50	A+++	0,90(0,25 - 1,37)	450	4,15	2,05	2,55	4,60(1,10 - 7,00)	4,84	A	4,60	A++	0,95(0,21 - 1,77)	475	4,40					
20+35	1,50	2,60	4,10(1,50 - 5,20)	4,56	A	8,50	A+++	0,90(0,25 - 1,37)	450	4,15	1,65	2,95	4,60(1,10 - 7,00)	4,84	A	4,60	A++	0,95(0,21 - 1,77)	475	4,40					
25+25	2,05	2,05	4,10(1,50 - 5,20)	4,56	A	8,50	A+++	0,90(0,25 - 1,37)	450	4,15	2,30	2,30	4,60(1,10 - 7,00)	4,84	A	4,60	A++	0,95(0,21 - 1,77)	475	4,40					
25+35	1,70	2,40	4,10(1,50 - 5,20)	4,56	A	8,50	A+++	0,90(0,25 - 1,37)	450	4,15	1,90	2,70	4,60(1,10 - 7,00)	4,84	A	4,60	A++	0,95(0,21 - 1,77)	475	4,40					

Free Multi 2x1 CU-2Z50TBE. Minimum capacity connected: 3,20 kW. Maximum capacity connected: 7,70 kW • R32 GAS

Indoor unit capacity	Cooling capacity (kW) Rooms					EER	SEER ¹	Input power rating			A.E.C.	Current	Heating capacity (kW) Rooms				COP	SCOP ¹	Input power rating			A.E.C.	Current		
	A	B	Total (Min - Max)	W/W	W/W			kW	kWh	230V			A	B	Total (Min - Max)	W/W			W/W	kW	kWh			230V	
1 Room																									
16	1,60		1,60(1,10 - 2,30)	3,90	A		0,41(0,22 - 0,60)	205	1,95	2,60		2,60(0,70 - 3,80)	3,77	A		0,69(0,17 - 1,11)	345	3,20							
20	2,00		2,00(1,10 - 2,90)	3,85	A		0,52(0,22 - 0,77)	260	2,45	3,20		3,20(0,70 - 4,80)	3,76	A		0,85(0,17 - 1,41)	425	3,95							
25	2,50		2,50(1,10 - 3,50)	3,73	A		0,67(0,22 - 1,00)	335	3,15	3,60		3,60(0,70 - 5,50)	3,50	B		1,03(0,17 - 1,70)	515	4,75							
35	3,50		3,50(1,10 - 4,00)	3,47	A		1,01(0,22 - 1,22)	505	4,70	4,50		4,50(0,70 - 6,20)	3,60	B		1,25(0,17 - 1,81)	625	5,80							
42	4,20		4,20(1,10 - 4,50)	3,09	B		1,36(0,22 - 1,50)	680	6,35	5,00		5,00(1,10 - 6,40)	3,23	C		1,55(0,21 - 2,18)	775	7,15							
50	5,00		5,00(1,20 - 5,10)	2,96	C		1,69(0,23 - 1,79)	845	7,80	5,30		5,30(1,10 - 6,80)	3,23	C		1,64(0,21 - 2,29)	820	7,60							
2 Rooms																									
16+16	1,60	1,60	3,20(1,50 - 4,00)	4,71	A	8,50	A+++	0,68(0,25 - 0,99)	340	3,15	2,60	2,60	5,20(1,10 - 7,00)	4,60	A	4,60	A++	1,13(0,21 - 1,81)	565	5,10					
16+20	1,60	2,00	3,60(1,50 - 4,50)	4,62	A	8,50	A+++	0,78(0,25 - 1,15)	390	3,60	2,40	3,00	5,40(1,10 - 7,00)	4,58	A	4,60	A++	1,18(0,21 - 1,79)	590	5,35					
16+25	1,60	2,50	4,10(1,50 - 5,20)	4,56	A	8,50	A+++	0,90(0,25 - 1,37)	450	4,15	2,10	3,30	5,40(1,10 - 7,00)	4,58	A	4,60	A++	1,18(0,21 - 1,79)	590	5,35					
16+35	1,55	3,45	5,00(1,50 - 5,20)	4,24	A	8,50	A+++	1,18(0,25 - 1,37)	590	5,35	1,70	3,70	5,40(1,10 - 7,00)	4,58	A	4,60	A++	1,18(0,21 - 1,79)	590	5,35					
16+42	1,40	3,60	5,00(1,50 - 5,40)	4,24	A	8,50	A+++	1,18(0,25 - 1,49)	590	5,35	1,55	4,05	5,60(1,10 - 7,20)	4,63	A	4,60	A++	1,21(0,21 - 1,80)	605	5,50					
16+50	1,20	3,80	5,00(1,50 - 5,40)	4,24	A	8,50	A+++	1,18(0,25 - 1,49)	590	5,35	1,35	4,25	5,60(1,10 - 7,20)	4,63	A	4,60	A++	1,21(0,21 - 1,80)	605	5,50					
20+20	2,00	2,00	4,00(1,50 - 5,00)	4,49	A	8,50	A+++	0,89(0,25 - 1,31)	445	4,10	2,70	2,70	5,40(1,10 - 7,00)	4,62	A	4,60	A++	1,17(0,21 - 1,77)	585	5,30					
20+25	2,00	2,50	4,50(1,50 - 5,20)	4,37	A	8,50	A+++	1,03(0,25 - 1,37)	515	4,65	2,40	3,00	5,40(1,10 - 7,00)	4,62	A	4,60	A++	1,17(0,21 - 1,77)	585	5,30					
20+35	1,80	3,20	5,00(1,50 - 5,40)	4,24	A	8,50	A+++	1,18(0,25 - 1,49)	590	5,35	2,05	3,55	5,60(1,10 - 7,20)	4,63	A	4,60	A++	1,21(0,21 - 1,80)	605	5,50					
20+42	1,60	3,40	5,00(1,50 - 5,40)	4,24	A	8,50	A+++	1,18(0,25 - 1,49)	590	5,35	1,80	3,80	5,60(1,10 - 7,20)	4,63	A	4,60	A++	1,21(0,21 - 1,80)	605	5,50					
20+50	1,45	3,55	5,00(1,50 - 5,40)	4,24	A	8,50	A+++	1,18(0,25 - 1,49)	590	5,35	1,60	4,00	5,60(1,10 - 7,20)	4,63	A	4,60	A++	1,21(0,21 - 1,80)	605	5,50					
25+25	2,50	2,50	5,00(1,50 - 5,40)	4,24	A	8,50	A+++	1,18(0,25 - 1,49)	590	5,35	2,80	2,80	5,60(1,10 - 7,20)	4,63	A	4,60	A++	1,21(0,21 - 1,80)	605	5,50					
25+35	2,10	2,90	5,00(1,50 - 5,40)	4,24	A	8,50	A+++	1,18(0,25 - 1,49)	590	5,35	2,35	3,25	5,60(1,10 - 7,20)	4,63	A	4,60	A++	1,21(0,21 - 1,80)	605	5,50					
25+42	1,85	3,15	5,00(1,50 - 5,40)	4,24	A	8,50	A+++	1,18(0,25 - 1,49)	590	5,35	2,10	3,50	5,60(1,10 - 7,20)	4,63	A	4,60	A++	1,21(0							

Free Multi System Z

R32

Free Multi 3x1 CU-3Z52TBE. Minimum capacity connected: 4,50 kW. Maximum capacity connected: 9,50 kW • R32 GAS

Indoor unit capacity	Cooling capacity (kW) Rooms				EER	SEER ¹	Input power rating	A.E.C.	Current	Heating capacity (kW) Rooms				COP	SCOP ¹	Input power rating	A.E.C.	Current
	A	B	C	Total (Min - Max)						W/W	W/W	kW	kWh					
1 Room																		
16	1,60			1,60(1,30 - 2,30)	4,00 A		0,40(0,25 - 0,64)	200	2,00	2,60			2,60(1,20 - 3,20)	4,33 A		0,60(0,30 - 0,96)	300	3,00
20	2,00			2,00(1,80 - 2,90)	4,00 A		0,50(0,34 - 0,81)	250	2,50	3,20			3,20(1,20 - 4,10)	4,32 A		0,74(0,30 - 1,23)	370	3,70
25	2,50			2,50(1,80 - 2,90)	3,97 A		0,63(0,34 - 0,81)	315	3,00	3,60			3,60(1,20 - 4,30)	3,83 A		0,94(0,30 - 1,23)	470	4,50
35	3,50			3,50(1,80 - 3,80)	3,72 A		0,94(0,34 - 1,36)	470	4,30	4,50			4,50(1,20 - 5,80)	3,66 A		1,23(0,30 - 2,10)	615	5,80
42	4,20			4,20(1,80 - 4,30)	3,07 B		1,37(0,34 - 1,99)	685	6,10	5,60			5,60(1,20 - 6,80)	3,26 C		1,72(0,30 - 2,93)	860	7,70
50	5,00			5,00(1,90 - 5,70)	3,23 A		1,55(0,34 - 2,13)	775	6,80	6,80			6,80(1,20 - 6,90)	3,24 C		2,10(0,30 - 2,52)	1050	9,20
2 Rooms																		
16+16	1,60	1,60		3,20(1,80 - 6,20)	5,42 A	7,00	0,59(0,33 - 2,09)	295	2,90	2,60	2,60		5,20(1,40 - 7,00)	4,13 A	3,80	1,26(0,34 - 1,99)	630	5,80
16+20	1,60	2,00		3,60(1,80 - 6,20)	4,93 A	7,00	0,73(0,33 - 2,05)	365	3,50	2,58	3,22		5,80(1,40 - 7,00)	4,03 A	3,80	1,44(0,33 - 1,95)	720	6,60
16+25	1,60	2,50		4,10(1,80 - 6,20)	4,66 A	7,00	0,88(0,33 - 2,05)	440	4,10	2,42	3,78		6,20(1,40 - 7,00)	3,95 A	3,80	1,57(0,33 - 1,95)	785	7,20
16+35	1,60	3,50		5,10(1,80 - 6,30)	3,89 A	7,00	1,31(0,33 - 2,06)	655	6,00	2,13	4,67		6,80(1,40 - 7,30)	3,89 A	3,80	1,75(0,29 - 2,05)	875	7,90
16+42	1,43	3,77		5,20(1,90 - 6,40)	3,85 A	7,00	1,35(0,35 - 2,10)	675	6,20	1,88	4,92		6,80(1,40 - 7,30)	3,98 A	3,80	1,71(0,31 - 2,04)	855	7,80
16+50	1,26	3,94		5,20(1,90 - 6,80)	4,44 A	7,20	1,17(0,34 - 2,04)	585	5,40	1,65	5,15		6,80(1,40 - 8,00)	4,36 A	4,00	1,56(0,27 - 2,15)	780	7,10
20+20	2,00	2,00		4,00(1,80 - 6,20)	4,71 A	7,00	0,85(0,33 - 2,01)	425	4,00	3,20	3,20		6,40(1,40 - 7,00)	3,93 A	3,80	1,63(0,32 - 1,95)	815	7,40
20+25	2,00	2,50		4,50(1,80 - 6,20)	4,33 A	7,00	1,04(0,33 - 2,01)	520	4,80	3,02	3,78		6,80(1,40 - 7,00)	3,86 A	3,80	1,76(0,29 - 1,95)	880	8,00
20+35	1,89	3,31		5,20(1,80 - 6,30)	3,85 A	7,00	1,35(0,33 - 2,02)	675	6,20	2,47	4,33		6,80(1,40 - 7,30)	3,98 A	3,80	1,71(0,32 - 2,04)	855	7,80
20+42	1,68	3,52		5,20(1,90 - 6,40)	3,94 A	7,00	1,32(0,35 - 2,06)	660	6,00	2,19	4,61		6,80(1,40 - 7,30)	4,00 A	3,80	1,70(0,30 - 2,00)	850	7,80
20+50	1,49	3,71		5,20(1,90 - 6,80)	4,44 A	7,20	1,17(0,34 - 2,04)	585	5,40	1,94	4,86		6,80(1,40 - 8,00)	4,36 A	4,00	1,56(0,27 - 2,15)	780	7,10
25+25	2,50	2,50		5,00(1,80 - 6,20)	3,91 A	7,00	1,28(0,33 - 2,01)	640	5,80	3,40	3,40		6,80(1,40 - 7,00)	3,86 A	3,80	1,76(0,29 - 1,95)	880	8,00
25+35	2,17	3,03		5,20(1,90 - 6,30)	3,85 A	7,00	1,35(0,35 - 2,02)	675	6,20	2,83	3,97		6,80(1,40 - 7,30)	3,98 A	3,80	1,71(0,28 - 2,04)	855	7,80
25+42	1,94	3,26		5,20(1,90 - 6,40)	3,94 A	7,00	1,32(0,35 - 2,06)	660	6,00	2,54	4,26		6,80(1,40 - 7,30)	4,00 A	3,80	1,70(0,28 - 2,00)	850	7,80
25+50	1,73	3,47		5,20(1,90 - 6,80)	4,44 A	7,20	1,17(0,34 - 2,04)	585	5,40	2,27	4,53		6,80(1,40 - 8,00)	4,36 A	4,00	1,56(0,24 - 2,15)	780	7,10
35+35	2,60	2,60		5,20(1,90 - 6,40)	4,06 A	7,00	1,28(0,35 - 2,02)	640	5,80	3,40	3,40		6,80(1,40 - 7,50)	4,02 A	3,80	1,69(0,27 - 2,06)	845	7,70
35+42	2,36	2,84		5,20(1,90 - 6,50)	4,06 A	7,00	1,28(0,35 - 2,07)	640	5,80	3,09	3,71		6,80(1,40 - 7,50)	4,02 A	3,80	1,69(0,26 - 2,06)	845	7,70
35+50	2,14	3,06		5,20(1,90 - 6,90)	4,60 A	7,20	1,13(0,36 - 2,04)	565	5,20	2,80	4,00		6,80(1,40 - 8,00)	4,42 A	4,00	1,54(0,24 - 2,08)	770	7,00
42+42	2,60	2,60		5,20(1,90 - 6,50)	4,06 A	7,00	1,28(0,35 - 2,07)	640	5,80	3,40	3,40		6,80(1,40 - 7,60)	4,12 A	3,80	1,65(0,26 - 2,09)	825	7,50
42+50	2,37	2,83		5,20(1,90 - 6,90)	4,60 A	7,20	1,13(0,36 - 2,04)	565	5,20	3,10	3,70		6,80(1,40 - 8,00)	4,44 A	4,00	1,53(0,24 - 2,08)	765	7,00
3 Rooms																		
16+16+16	1,60	1,60	1,60	4,80(1,80 - 7,20)	5,05 A	8,50	0,95(0,36 - 2,13)	475	4,40	2,26	2,26	2,26	6,78(1,50 - 8,10)	4,58 A	4,20	1,48(0,29 - 2,10)	740	6,80
16+16+20	1,60	1,60	2,00	5,20(1,80 - 7,30)	4,77 A	8,50	1,09(0,36 - 2,18)	545	5,00	2,09	2,09	2,62	6,80(1,60 - 8,30)	4,63 A	4,20	1,47(0,32 - 2,17)	735	6,70
16+16+25	1,46	1,46	2,28	5,20(1,90 - 7,20)	4,77 A	8,50	1,09(0,39 - 2,09)	545	5,00	1,91	1,91	2,98	6,80(1,60 - 8,30)	4,63 A	4,20	1,47(0,32 - 2,17)	735	6,70
16+16+35	1,24	1,24	2,72	5,20(1,90 - 7,20)	4,77 A	8,50	1,09(0,39 - 2,04)	545	5,00	1,62	1,62	3,56	6,80(1,60 - 8,30)	4,69 A	4,20	1,45(0,34 - 2,10)	725	6,60
16+16+42	1,12	1,12	2,96	5,20(1,80 - 7,30)	4,77 A	8,50	1,09(0,39 - 2,09)	545	5,00	1,47	1,47	3,86	6,80(1,60 - 8,30)	4,69 A	4,20	1,45(0,31 - 2,10)	725	6,60
16+16+50	1,01	1,01	3,18	5,20(1,80 - 7,30)	5,15 A	8,50	1,01(0,42 - 1,91)	505	4,70	1,33	1,33	4,14	6,80(1,60 - 8,30)	5,07 A	4,20	1,34(0,33 - 1,96)	670	6,10
16+20+20	1,48	1,86	1,86	5,20(1,90 - 7,20)	4,77 A	8,50	1,09(0,39 - 2,09)	545	5,00	1,94	2,43	2,43	6,80(1,60 - 8,30)	4,66 A	4,20	1,46(0,31 - 2,12)	730	6,70
16+20+25	1,36	1,70	2,14	5,20(1,90 - 7,20)	4,77 A	8,50	1,09(0,39 - 2,09)	545	5,00	1,78	2,23	2,79	6,80(1,60 - 8,30)	4,66 A	4,20	1,46(0,31 - 2,12)	730	6,70
16+20+35	1,17	1,46	2,57	5,20(1,90 - 7,20)	4,77 A	8,50	1,09(0,39 - 2,00)	545	5,00	1,53	1,92	3,35	6,80(1,60 - 8,30)	4,69 A	4,20	1,45(0,34 - 2,10)	725	6,60
16+20+42	1,07	1,33	2,80	5,20(1,80 - 7,30)	4,77 A	8,50	1,09(0,39 - 2,09)	545	5,00	1,39	1,74	3,67	6,80(1,60 - 8,30)	4,72 A	4,20	1,44(0,31 - 2,09)	720	6,60
16+20+50	0,97	1,21	3,02	5,20(1,80 - 7,30)	5,15 A	8,50	1,01(0,42 - 1,86)	505	4,70	1,27	1,58	3,95	6,80(1,60 - 8,30)	5,11 A	4,20	1,33(0,34 - 1,95)	665	6,10
16+25+25	1,26	1,97	1,97	5,20(1,90 - 7,20)	4,77 A	8,50	1,09(0,39 - 2,09)	545	5,00	1,64	2,58	2,58	6,80(1,60 - 8,30)	4,66 A	4,20	1,46(0,31 - 2,12)	730	6,70
16+25+35	1,09	1,71	2,40	5,20(1,80 - 7,30)	4,77 A	8,50	1,09(0,39 - 2,09)	545	5,00	1,43	2,24	3,13	6,80(1,60 - 8,30)	4,69 A	4,20	1,45(0,34 - 2,10)	725	6,60
16+25+42	1,00	1,57	2,63	5,20(1,80 - 7,30)	4,77 A	8,50	1,09(0,39 - 2,09)	545	5,00	1,31	2,05	3,44	6,80(1,60 - 8,30)	4,72 A	4,20	1,44(0,31 - 2,09)	720	6,60
16+25+50	0,91	1,43	2,86	5,20(1,80 - 7,30)	5,15 A	8,50	1,01(0,42 - 1,86)	505	4,70	1,19	1,87	3,74	6,80(1,60 - 8,30)	5,11 A	4,20	1,33(0,34 - 1,95)	665	6,10
16+35+35	0,96	2,12	2,12	5,20(1,80 - 7,30)	4,95 A	8,50	1,05(0,39 - 2,04)	525	4,80	1,26	2,77	2,77	6,80(1,60 - 8,30)	4,76 A	4,20	1,43(0,32 - 2,07)	715	6,50
16+35+42	0,89	1,96	2,35	5,20(1,80 - 7,30)	4,95 A	8,50	1,05(0,39 - 2,04)	525	4,80	1,17	2,56	3,07	6,80(1,60 - 8,30)	4,79 A	4,20	1,42(0,32 - 2,06)	710	6,50
20+20+20	1,73	1,73	1,73	5,19(1,90 - 7,20)	4,76 A	8,50	1,09(0,39 - 2,04)	545	5,00	2,26	2,26	2,26	6,78(1,60 - 8,30)	4,64 A	4,20	1,46(0,31 - 2,11)	730	6,70
20+20+25	1,60	1,60	2,00	5,20(1,90 - 7,20)	4,77 A	8,50	1,09(0,39 - 2,04)	545	5,00	2,09	2,09	2,62	6,80(1,60 - 8,30)	4,66 A	4,20	1,46(0,31 - 2,11)	730	6,70
20+20+35	1,39	1,39	2,42	5,20(1,90 - 7,20)	4,95 A	8,50	1,05(0,39 - 2,00)	525	4,80	1,81	1,81	3,18	6,80(1,60 - 8,30)	4,72 A	4,20	1,44(0,34 - 2,09)	720	6,60
20+20+42	1,27	1,27	2,66	5,20(1,80 - 7,30)	4,95 A	8,50	1,05(0,39 - 2,04)	525	4,80	1,66	1,66	3,48	6,80(1,60 - 8,30)	4,76 A	4,20	1,43(0,32 - 2,08)	715	6,50
20+20+50	1,16	1,16	2,88	5,20(1,80 - 7,30)	5,15 A	8,50	1,01(0,42 - 1,86)	505	4,70	1								

FREE MULTI R32 COMBINATIONS TABLE

Free Multi 3x1 CU-3Z68TBE. Minimum capacity connected: 4,50 kW. Maximum capacity connected: 11,20 kW • R32 GAS

Indoor unit capacity	Cooling capacity (kW) Rooms				EER	SEER ¹	Input power rating	A.E.C.	Current	Heating capacity (kW) Rooms				COP	SCOP ¹	Input power rating	A.E.C.	Current	
	A	B	C	Total (Min - Max)						W/W	W/W	kW	kWh						230V
1 Room																			
16	1,60			1,60(1,30-2,30)	4,00 A		0,40(0,25-0,64)	200	2,00	2,60			2,60(1,20-3,20)	4,33 A			0,60(0,30-0,96)	300	3,00
20	2,00			2,00(1,80-2,90)	4,00 A		0,50(0,34-0,81)	250	2,50	3,20			3,20(1,20-4,10)	4,32 A			0,74(0,30-1,23)	370	3,70
25	2,50			2,50(1,80-2,90)	3,97 A		0,63(0,34-0,81)	315	3,20	3,60			3,60(1,20-4,30)	3,83 A			0,94(0,30-1,23)	470	4,70
35	3,50			3,50(1,80-3,80)	3,72 A		0,94(0,34-1,36)	470	4,50	4,50			4,50(1,20-5,80)	3,66 A			1,23(0,30-2,10)	615	6,00
42	4,20			4,20(1,80-4,30)	3,07 B		1,37(0,34-1,99)	685	6,40	5,60			5,60(1,20-6,80)	3,26 C			1,72(0,30-2,93)	860	8,00
50	5,00			5,00(1,90-5,70)	3,23 A		1,55(0,34-2,13)	775	7,20	6,80			6,80(1,20-6,90)	3,24 C			2,10(0,30-2,52)	1050	9,70
60	6,00			6,00(1,90-6,20)	2,96 C		2,03(0,34-2,33)	1015	9,20	8,50			8,50(1,30-9,00)	3,54 B			2,40(0,62-2,55)	1200	11,10
2 Rooms																			
16+16	1,60	1,60		3,20(1,90-6,40)	5,71 A	6,10	0,56(0,27-2,12)	280	2,80	2,60	2,60		5,20(2,70-9,80)	4,00 A	3,80		1,30(0,66-3,01)	650	5,90
16+20	1,60	2,00		3,60(1,90-6,40)	5,22 A	6,10	0,69(0,27-2,08)	345	3,40	2,58	3,20		5,80(2,70-9,80)	3,92 A	3,80		1,48(0,65-3,02)	740	6,80
16+25	1,60	2,50		4,10(1,90-6,40)	4,94 A	6,10	0,83(0,27-2,08)	415	3,90	2,42	3,78		6,20(2,70-9,80)	3,85 A	3,80		1,61(0,65-3,02)	805	7,40
16+35	1,60	3,50		5,10(1,90-6,90)	4,08 A	6,10	1,25(0,27-2,48)	625	5,70	2,23	4,87		7,10(2,70-9,90)	3,74 A	3,80		1,90(0,63-3,02)	950	8,60
16+42	1,60	4,20		5,80(1,90-6,90)	3,60 A	6,10	1,61(0,27-2,44)	805	7,40	2,26	5,94		8,20(2,70-9,90)	3,52 B	3,80		2,33(0,63-3,02)	1165	10,50
16+50	1,60	5,00		6,60(2,00-7,50)	3,63 A	6,50	1,82(0,28-2,52)	910	8,20	2,06	6,44		8,50(2,80-10,20)	3,76 A	3,80		2,26(0,56-2,99)	1130	10,20
16+60	1,43	5,37		6,80(2,00-7,50)	3,49 A	6,50	1,95(0,28-2,52)	975	8,80	1,79	6,71		8,50(2,80-10,20)	3,76 A	3,80		2,26(0,56-2,99)	1130	10,20
20+20	2,00	2,00		4,00(1,90-6,40)	5,00 A	6,10	0,80(0,27-2,04)	400	3,80	3,20	3,20		6,40(2,70-9,80)	3,83 A	3,80		1,67(0,64-3,02)	835	7,60
20+25	2,00	2,50		4,50(1,90-6,40)	4,59 A	6,10	0,98(0,27-2,04)	490	4,60	3,02	3,78		6,80(2,70-9,80)	3,78 A	3,80		1,80(0,64-3,02)	900	8,10
20+35	2,00	3,50		5,50(1,90-6,90)	3,85 A	6,10	1,43(0,27-2,44)	715	6,50	2,80	4,90		7,70(2,70-9,90)	3,65 A	3,80		2,11(0,63-3,02)	1055	9,50
20+42	2,00	4,20		6,20(1,90-6,90)	3,35 A	6,10	1,85(0,27-2,40)	925	8,40	2,74	5,76		8,50(2,70-9,90)	3,48 B	3,80		2,44(0,62-3,03)	1220	11,00
20+50	1,94	4,86		6,80(2,00-7,50)	3,49 A	6,50	1,95(0,28-2,48)	975	8,80	2,43	6,07		8,50(2,80-10,20)	3,76 A	3,80		2,26(0,56-2,99)	1130	10,20
20+60	1,70	5,10		6,80(2,00-7,50)	3,49 A	6,50	1,95(0,28-2,48)	975	8,80	2,12	6,38		8,50(2,80-10,20)	3,76 A	3,80		2,26(0,56-2,99)	1130	10,20
25+25	2,50	2,50		5,00(1,90-6,80)	4,13 A	6,10	1,21(0,27-2,43)	605	5,60	3,60	3,60		7,20(2,70-9,80)	3,71 A	3,80		1,94(0,64-3,02)	970	8,80
25+35	2,50	3,50		6,00(1,90-6,90)	3,47 A	6,10	1,73(0,27-2,44)	865	7,90	3,37	4,73		8,10(2,70-9,90)	3,60 B	3,80		2,25(0,63-3,02)	1125	10,20
25+42	2,50	4,20		6,70(1,90-6,90)	2,94 C	6,10	2,28(0,27-2,40)	1140	10,30	3,17	5,33		8,50(2,70-9,90)	3,48 B	3,80		2,44(0,62-3,03)	1220	11,00
25+50	2,27	4,53		6,80(1,90-7,50)	3,49 A	6,50	1,95(0,26-2,48)	975	8,80	2,83	5,67		8,50(2,80-10,20)	3,76 A	3,80		2,26(0,56-2,99)	1130	10,20
25+60	2,00	4,80		6,80(1,90-7,50)	3,49 A	6,50	1,95(0,26-2,48)	975	8,80	2,50	6,00		8,50(2,80-10,20)	3,76 A	3,80		2,26(0,56-2,99)	1130	10,20
35+35	3,40	3,40		6,80(1,90-7,00)	2,97 C	6,10	2,29(0,27-2,40)	1145	10,40	4,25	4,25		8,50(2,80-10,00)	3,56 B	3,80		2,39(0,64-3,02)	1195	10,80
35+42	3,09	3,71		6,80(1,90-7,10)	3,04 B	6,10	2,24(0,27-2,50)	1120	10,10	3,86	4,64		8,50(2,80-10,00)	3,56 B	3,80		2,39(0,64-3,02)	1195	10,80
35+50	2,80	4,00		6,80(2,00-7,60)	3,64 A	6,50	1,87(0,28-2,48)	935	8,50	3,50	5,00		8,50(2,80-10,30)	3,86 A	3,80		2,20(0,54-2,97)	1100	10,00
35+60	2,51	4,29		6,80(2,00-7,60)	3,64 A	6,50	1,87(0,28-2,48)	935	8,50	3,13	5,37		8,50(2,80-10,30)	3,86 A	3,80		2,20(0,54-2,97)	1100	10,00
42+42	3,40	3,40		6,80(1,90-7,10)	3,02 B	6,10	2,25(0,26-2,45)	1125	10,20	4,25	4,25		8,50(2,80-10,00)	3,57 B	3,80		2,38(0,60-2,98)	1190	10,80
42+50	3,10	3,70		6,80(2,00-7,60)	3,64 A	6,50	1,87(0,28-2,44)	935	8,50	3,88	4,62		8,50(2,80-10,30)	3,88 A	3,80		2,19(0,54-2,96)	1095	9,90
42+60	2,80	4,00		6,80(2,00-7,60)	3,64 A	6,50	1,87(0,28-2,44)	935	8,50	3,50	5,00		8,50(2,80-10,30)	3,88 A	3,80		2,19(0,54-2,96)	1095	9,90
50+50	3,40	3,40		6,80(2,10-8,10)	4,10 A	6,50	1,66(0,32-2,50)	830	7,60	4,25	4,25		8,50(2,80-10,50)	4,15 A	3,80		2,05(0,51-2,87)	1025	9,30
50+60	3,09	3,71		6,80(2,10-8,10)	4,10 A	6,50	1,66(0,32-2,50)	830	7,60	3,86	4,64		8,50(2,80-10,50)	4,15 A	3,80		2,05(0,51-2,87)	1025	9,30
3 Rooms																			
16+16+16	1,60	1,60	1,60	4,80(1,90-8,00)	4,85 A	8,00	0,99(0,27-2,50)	495	4,60	2,60	2,60	2,60	7,80(3,30-10,40)	3,98 A	4,20		1,96(0,64-2,95)	980	8,90
16+16+20	1,60	1,60	2,00	5,20(1,90-8,00)	4,60 A	8,00	1,13(0,27-2,46)	565	5,20	2,58	2,58	3,24	8,40(3,30-10,40)	3,84 A	4,20		2,19(0,64-2,94)	1095	9,90
16+16+25	1,60	1,60	2,50	5,70(1,90-8,00)	4,19 A	8,00	1,36(0,27-2,46)	680	6,20	2,39	2,39	3,72	8,50(3,30-10,40)	3,81 A	4,20		2,23(0,64-2,94)	1115	10,10
16+16+35	1,60	1,60	3,50	6,70(1,90-8,00)	3,68 A	8,00	1,82(0,27-2,37)	910	8,20	2,03	2,03	4,44	8,50(3,30-10,40)	3,94 A	4,20		2,16(0,63-2,92)	1080	9,80
16+16+42	1,47	1,47	3,86	6,80(1,90-8,10)	3,66 A	8,00	1,86(0,27-2,46)	930	8,40	1,84	1,84	4,82	8,50(3,30-10,50)	3,95 A	4,20		2,15(0,62-2,95)	1075	9,70
16+16+50	1,33	1,33	4,14	6,80(2,00-8,50)	3,93 A	8,00	1,73(0,32-2,42)	865	7,90	1,66	1,66	5,18	8,50(3,20-10,60)	4,21 A	4,20		2,02(0,60-2,80)	1010	9,10
16+16+60	1,18	1,18	4,44	6,80(2,00-8,50)	3,93 A	8,00	1,73(0,32-2,42)	865	7,90	1,48	1,48	5,54	8,50(3,20-10,60)	4,21 A	4,20		2,02(0,60-2,80)	1010	9,10
16+20+20	1,60	2,00	2,00	5,60(1,90-8,00)	4,38 A	8,00	1,28(0,27-2,46)	640	5,80	2,42	3,04	3,04	8,50(3,30-10,40)	3,83 A	4,20		2,22(0,63-2,93)	1110	10,00
16+20+25	1,60	2,00	2,50	6,10(1,90-8,00)	4,01 A	8,00	1,52(0,27-2,46)	760	6,90	2,23	2,79	3,48	8,50(3,30-10,40)	3,83 A	4,20		2,22(0,63-2,93)	1110	10,00
16+20+35	1,53	1,92	3,35	6,80(1,90-8,00)	3,66 A	8,00	1,86(0,27-2,37)	930	8,40	1,92	2,39	4,19	8,50(3,30-10,40)	3,95 A	4,20		2,15(0,62-2,86)	1075	9,70
16+20+42	1,39	1,74	3,67	6,80(1,90-8,10)	3,66 A	8,00	1,86(0,27-2,42)	930	8,40	1,74	2,18	4,58	8,50(3,30-10,50)	3,95 A	4,20		2,15(0,62-2,90)	1075	9,70
16+20+50	1,27	1,58	3,95	6,80(2,00-8,50)	4,05 A	8,00	1,68(0,32-2,42)	840	7,70	1,58	1,98	4,94	8,50(3,20-10,60)	4,23 A	4,20		2,01(0,60-2,79)	1005	9,10
16+20+60	1,13	1,42	4,25	6,80(2,00-8,50)	4,05 A	8,00	1,68(0,32-2,42)	840	7,70	1,42	1,77	5,31	8,50(3,20-10,60)	4,23 A	4,20		2,01(0,60-2,79)	1005	9,10
16+25+25	1,60	2,50	2,50	6,60(1,90-8,00)	3,73 A	8,00	1,77(0,27-2,46)	885	8,00	2,06	3,22	3,22	8,50(3,30-10,40)	3,83 A	4,20		2,22(0,63-2,93)	1110	10,00
16+25+35	1,43	2,24	3,13	6,80(1,90-8,00)	3,66 A	8,00	1,86(0,27-2,46)	930	8,40	1,79	2,80	3,91	8,50(3,30-10,40)	3,95 A	4,20		2,15(0,62-2,86)	1075	9,70
16+25+42	1,31	2,05	3,44	6,80(1,90-8,10)	3,66 A	8,00	1,86(0,27-2,42)	930	8,40	1,64	2,56	4,30	8,50(3,30-10,50)	3,95 A	4,20</				

Free Multi 3x1 CU-3Z68TBE. Minimum capacity connected: 4,50 kW. Maximum capacity connected: 11,20 kW • R32 GAS

Indoor unit capacity	Cooling capacity (kW) Rooms				EER	SEER ¹	Input power rating			A.E.C.	Current	Heating capacity (kW) Rooms				COP	SCOP ¹	Input power rating			A.E.C.	Current
	A	B	C	Total (Min - Max)			W/W	W/W	kW			kWh	230V	A	B			C	Total (Min - Max)	W/W		
25+25+25	2,26	2,26	2,26	6,78(1,90-8,00)	3,65 A	8,00	1,86(0,27-2,41)	930	8,40	2,83	2,83	2,83	8,49(3,30-10,40)	3,91 A	4,20	2,17(0,63-2,92)	1085	9,80				
25+25+35	2,00	2,00	2,80	6,80(1,90-8,00)	3,66 A	8,00	1,86(0,27-2,32)	930	8,40	2,50	2,50	3,50	8,50(3,30-10,40)	3,95 A	4,20	2,15(0,62-2,85)	1075	9,70				
25+25+42	1,85	1,85	3,10	6,80(1,90-8,10)	3,74 A	8,00	1,82(0,29-2,42)	910	8,20	2,31	2,31	3,88	8,50(3,30-10,50)	3,97 A	4,20	2,14(0,62-2,89)	1070	9,70				
25+25+50	1,70	1,70	3,40	6,80(2,00-8,50)	4,05 A	8,00	1,68(0,34-2,38)	840	7,70	2,13	2,13	4,24	8,50(3,20-10,60)	4,25 A	4,20	2,00(0,60-2,78)	1000	9,00				
25+25+60	1,55	1,55	3,70	6,80(2,00-8,50)	4,05 A	8,00	1,68(0,34-2,38)	840	7,70	1,93	1,93	4,64	8,50(3,20-10,60)	4,25 A	4,20	2,00(0,60-2,78)	1000	9,00				
25+35+35	1,78	2,51	2,51	6,80(1,90-8,10)	3,74 A	8,00	1,82(0,29-2,33)	910	8,20	2,24	3,13	3,13	8,50(3,30-10,50)	4,01 A	4,20	2,12(0,64-2,87)	1060	9,60				
25+35+42	1,67	2,33	2,80	6,80(1,90-8,20)	3,74 A	8,00	1,82(0,29-2,42)	910	8,20	2,08	2,92	3,50	8,50(3,30-10,50)	4,03 A	4,20	2,11(0,64-2,86)	1055	9,50				
25+35+50	1,55	2,16	3,09	6,80(2,00-8,50)	4,05 A	8,00	1,68(0,34-2,33)	840	7,70	1,93	2,70	3,87	8,50(3,20-10,60)	4,29 A	4,20	1,98(0,60-2,76)	990	9,00				
25+42+42	1,56	2,62	2,62	6,80(1,90-8,20)	3,84 A	8,00	1,77(0,29-2,37)	885	8,00	1,94	3,28	3,28	8,50(3,30-10,50)	4,05 A	4,20	2,10(0,63-2,86)	1050	9,50				
35+35+35	2,26	2,26	2,26	6,78(1,90-8,20)	3,83 A	8,00	1,77(0,29-2,33)	885	8,00	2,83	2,83	2,83	8,49(3,30-10,50)	4,12 A	4,20	2,06(0,63-2,85)	1030	9,30				
35+35+42	2,13	2,13	2,54	6,80(1,90-8,20)	3,84 A	8,00	1,77(0,29-2,33)	885	8,00	2,66	2,66	3,18	8,50(3,30-10,50)	4,15 A	4,20	2,05(0,63-2,80)	1025	9,30				

1) Energy Label Scale from A+++ to D.

Free Multi 4x1 CU-4Z68TBE. Minimum capacity connected: 4,50 kW. Maximum capacity connected: 11,50 kW • R32 GAS

Indoor unit capacity	Cooling capacity (kW) Rooms					EER	SEER ¹	Input power rating			A.E.C.	Current	Heating capacity (kW) Rooms					COP	SCOP ¹	Input power rating			A.E.C.	Current	
	A	B	C	D	Total (Min - Max)			W/W	W/W	kW			kWh	230V	A	B	C			D	Total (Min - Max)	W/W			W/W
1 Room																									
16	1,60				1,60(1,30-2,30)	4,00 A	6,10	0,40(0,25-0,64)	200	2,00	2,60				2,60(1,20-3,20)	4,33 A	3,80	0,60(0,30-0,96)	300	3,00					
20	2,00				2,00(1,80-2,90)	4,00 A	6,10	0,50(0,34-0,81)	250	2,50	3,20				3,20(1,20-4,10)	4,32 A	3,80	0,74(0,30-1,23)	370	3,70					
25	2,50				2,50(1,80-2,90)	3,97 A	6,10	0,63(0,34-0,81)	315	3,20	3,60				3,60(1,20-4,30)	3,83 A	3,80	0,94(0,30-1,23)	470	4,70					
35	3,50				3,50(1,80-3,80)	3,72 A	6,10	0,94(0,34-1,36)	470	4,50	4,50				4,50(1,20-5,80)	3,66 A	3,80	1,23(0,30-2,10)	615	6,00					
42	4,20				4,20(1,80-4,30)	3,07 B	6,10	1,37(0,34-1,99)	685	6,40	5,60				5,60(1,20-6,80)	3,26 C	3,80	1,72(0,30-2,93)	860	8,00					
50	5,00				5,00(1,90-5,70)	3,23 A	6,10	1,55(0,34-2,13)	775	7,20	6,80				6,80(1,20-6,90)	3,24 C	3,80	2,10(0,30-2,52)	1050	9,70					
60	6,00				6,00(1,90-6,20)	2,96 C	6,10	2,03(0,34-2,33)	1015	9,20	8,50				8,50(1,30-9,00)	3,54 B	3,80	2,40(0,62-2,55)	1200	11,10					
2 Rooms																									
16+16	1,60	1,60			3,20(1,90-6,40)	5,71 A	6,10	0,56(0,27-2,12)	280	2,80	2,60	2,60			5,20(2,70-9,80)	4,00 A	3,80	1,30(0,66-3,01)	650	5,90					
16+20	1,60	2,00			3,60(1,90-6,40)	5,22 A	6,10	0,69(0,27-2,08)	345	3,40	2,58	3,22			5,80(2,70-9,80)	3,92 A	3,80	1,48(0,65-3,02)	740	6,80					
16+25	1,60	2,50			4,10(1,90-6,40)	4,94 A	6,10	0,83(0,27-2,08)	415	3,90	2,42	3,78			6,20(2,70-9,80)	3,85 A	3,80	1,61(0,65-3,02)	805	7,40					
16+35	1,60	3,50			5,10(1,90-6,90)	4,08 A	6,10	1,25(0,27-2,48)	625	5,70	2,23	4,87			7,10(2,70-9,90)	3,74 A	3,80	1,90(0,63-3,02)	950	8,60					
16+42	1,60	4,20			5,80(1,90-6,90)	3,60 A	6,10	1,61(0,27-2,44)	805	7,40	2,26	5,94			8,20(2,70-9,90)	3,52 B	3,80	2,33(0,63-3,02)	1165	10,50					
16+50	1,60	5,00			6,60(2,00-7,50)	3,63 A	6,50	1,82(0,28-2,52)	910	8,20	2,06	6,44			8,50(2,80-10,20)	3,76 A	3,80	2,26(0,56-2,99)	1130	10,20					
16+60	1,43	5,37			6,80(2,00-7,50)	3,49 A	6,50	1,95(0,28-2,52)	975	8,80	1,79	6,71			8,50(2,80-10,20)	3,76 A	3,80	2,26(0,56-2,99)	1130	10,20					
20+20	2,00	2,00			4,00(1,90-6,40)	5,00 A	6,10	0,80(0,27-2,04)	400	3,80	3,20	3,20			6,40(2,70-9,80)	3,83 A	3,80	1,67(0,64-3,02)	835	7,60					
20+25	2,00	2,50			4,50(1,90-6,40)	4,59 A	6,10	0,98(0,27-2,04)	490	4,60	3,02	3,78			6,80(2,70-9,80)	3,78 A	3,80	1,80(0,64-3,02)	900	8,10					
20+35	2,00	3,50			5,50(1,90-6,90)	3,85 A	6,10	1,43(0,27-2,44)	715	6,50	2,80	4,90			7,70(2,70-9,90)	3,65 A	3,80	2,11(0,63-3,02)	1055	9,50					
20+42	2,00	4,20			6,20(1,90-6,90)	3,35 A	6,10	1,85(0,27-2,40)	925	8,50	2,74	5,76			8,50(2,70-9,90)	3,48 B	3,80	2,44(0,62-3,03)	1220	11,00					
20+50	1,94	4,86			6,80(2,00-7,50)	3,49 A	6,50	1,95(0,28-2,48)	975	8,80	2,43	6,07			8,50(2,80-10,20)	3,76 A	3,80	2,26(0,56-2,99)	1130	10,20					
20+60	1,70	5,10			6,80(2,00-7,50)	3,49 A	6,50	1,95(0,28-2,48)	975	8,80	2,12	6,38			8,50(2,80-10,20)	3,76 A	3,80	2,26(0,56-2,99)	1130	10,20					
25+25	2,50	2,50			5,00(1,90-6,80)	4,13 A	6,10	1,21(0,27-2,43)	605	5,60	3,60	3,60			7,20(2,70-9,80)	3,71 A	3,80	1,94(0,64-3,02)	970	8,80					
25+35	2,50	3,50			6,00(1,90-6,90)	3,47 A	6,10	1,73(0,27-2,44)	865	7,90	3,37	4,73			8,10(2,70-9,90)	3,60 B	3,80	2,25(0,63-3,02)	1125	10,20					
25+42	2,50	4,20			6,70(1,90-6,90)	2,94 C	6,10	2,28(0,27-2,40)	1140	10,30	3,17	5,33			8,50(2,70-9,90)	3,48 B	3,80	2,44(0,62-3,03)	1220	11,00					
25+50	2,27	4,53			6,80(1,90-7,50)	3,49 A	6,50	1,95(0,26-2,48)	975	8,80	2,83	5,67			8,50(2,80-10,20)	3,76 A	3,80	2,26(0,56-2,99)	1130	10,20					
25+60	2,00	4,80			6,80(1,90-7,50)	3,49 A	6,50	1,95(0,26-2,48)	975	8,80	2,50	6,00			8,50(2,80-10,20)	3,76 A	3,80	2,26(0,56-2,99)	1130	10,20					
35+35	3,40	3,40			6,80(1,90-7,00)	2,97 C	6,10	2,29(0,27-2,40)	1145	10,40	4,25	4,25			8,50(2,80-10,00)	3,56 B	3,80	2,39(0,64-3,02)	1195	10,80					
35+42	3,09	3,71			6,80(1,90-7,10)	3,04 B	6,10	2,24(0,27-2,50)	1120	10,10	3,86	4,64			8,50(2,80-10,00)	3,56 B	3,80	2,39(0,60-3,02)	1195	10,80					
35+50	2,80	4,00			6,80(2,00-7,60)	3,64 A	6,50	1,87(0,28-2,48)	935	8,50	3,50	5,00			8,50(2,80-10,30)	3,86 A	3,80	2,20(0,54-2,97)	1100	10,00					
35+60	2,51	4,29			6,80(2,00-7,60)	3,64 A	6,50	1,87(0,28-2,48)	935	8,50	3,13	5,37			8,50(2,80-10,30)	3,86 A	3,80	2,20(0,54-2,97)	1100	10,00					
42+42	3,40	3,40			6,80(1,90-7,10)	3,02 B	6,10	2,25(0,26-2,45)	1125	10,20	4,25	4,25			8,50(2,80-10,00)	3,57 B	3,80	2,38(0,60-2,98)	1190	10,80					
42+50	3,10	3,70			6,80(2,00-7,60)	3,64 A	6,50	1,87(0,28-2,44)	935	8,50	3,88	4,62			8,50(2,80-10,30)	3,88 A	3,80	2,19(0,54-2,96)	1095	9,90					
42+60	2,80	4,00			6,80(2,00-7,60)	3,64 A	6,50	1,87(0,28-2,44)	935	8,50	3,50	5,00			8,50(2,80-10,30)	3,88 A	3,80	2,19(0,54-2,96)	1095	9,90					
50+50	3,40	3,40			6,80(2,10-8,10)	4,10 A	6,50	1,66(0,32-2,50)	830	7,60	4,25	4,25			8,50(2,80-10,50)	4,15 A	3,80	2,05(0,51-2,87)	1025	9,30					
50+60	3,09	3,71			6,80(2,10-8,10)	4,10 A	6,50	1,66(0,32-2,50)	830	7,60	3,86	4,64			8,50(2,80-10,50)	4,15 A	3,80	2,05(0,51-2,87)	1025	9,30					
3 Rooms																									
16+16+16	1,60	1,60	1,60		4,80(1,90-8,00)	4,85 A	8,00	0,99(0,27-2,50)	495	4,60	2,60	2,60	2,60		7,80(3,30-10,40)	3,98 A	4,00	1,96(0,64-2,95)	980	8,90					
16+16+20	1,60	1,60	2,00		5,20(1,90-8,00)	4,60 A	8,00	1,13(0,27-2,46)	565	5,20	2,58	2,58	3,24		8,40(3,30-10,40)	3,84 A	4,00	2,19(0,64-2,94)	1095	9,90					

FREE MULTI R32 COMBINATIONS TABLE

Free Multi 4x1 CU-4Z68TBE. Minimum capacity connected: 4,50 kW. Maximum capacity connected: 11,50 kW • R32 GAS

Indoor unit capacity	Cooling capacity (kW) Rooms					EER	SEER ¹	Input power rating			A.E.C. Current		Heating capacity (kW) Rooms					COP	SCOP ¹	Input power rating			A.E.C. Current	
	A	B	C	D	Total (Min - Max)	W/W	W/W	kW			kWh	230V	A	B	C	D	Total (Min - Max)	W/W	W/W	kW			kWh	230V
16+35+50	1,07	2,36	3,37		6,80(2,00-8,50)	4,05	8,00	1,68	0,34	-2,38	840	7,70	1,34	2,95	4,21	8,50(3,20-10,60)	4,27	4,00	1,99	0,60	-2,77	995	9,00	
16+35+60	0,98	2,14	3,68		6,80(2,00-8,50)	4,05	8,00	1,68	0,34	-2,38	840	7,70	1,23	2,68	4,59	8,50(3,20-10,60)	4,27	4,00	1,99	0,60	-2,77	995	9,00	
16+42+42	1,08	2,86	2,86		6,80(1,90-8,20)	3,74	8,00	1,82	0,29	-2,42	910	8,20	1,36	3,57	3,57	8,50(3,30-10,50)	4,03	4,00	2,11	0,64	-2,86	1055	9,50	
16+42+50	1,01	2,64	3,15		6,80(2,00-8,50)	4,05	8,00	1,68	0,34	-2,33	840	7,70	1,25	3,31	3,94	8,50(3,20-10,60)	4,29	4,00	1,98	0,60	-2,76	990	9,00	
20+20+20	2,00	2,00	2,00		6,00(1,90-8,00)	4,05	8,00	1,48	0,27	-2,41	740	6,80	2,83	2,83	2,83	8,49(3,30-10,40)	3,91	4,00	2,17	0,63	-2,92	1085	9,80	
20+20+25	2,00	2,00	2,50		6,50(1,90-8,00)	3,76	8,00	1,73	0,27	-2,41	865	7,90	2,62	2,62	3,26	8,50(3,30-10,40)	3,92	4,00	2,17	0,63	-2,92	1085	9,80	
20+20+35	1,81	1,81	3,18		6,80(1,90-8,00)	3,66	8,00	1,86	0,27	-2,32	930	8,40	2,27	2,27	3,96	8,50(3,30-10,40)	3,95	4,00	2,15	0,62	-2,85	1075	9,70	
20+20+42	1,66	1,66	3,48		6,80(1,90-8,00)	3,74	8,00	1,82	0,29	-2,42	910	8,20	2,07	2,07	4,36	8,50(3,30-10,50)	3,97	4,00	2,14	0,62	-2,89	1070	9,70	
20+20+50	1,51	1,51	3,78		6,80(2,00-8,50)	4,05	8,00	1,68	0,34	-2,38	840	7,70	1,89	1,89	4,72	8,50(3,20-10,60)	4,25	4,00	2,00	0,60	-2,78	1000	9,00	
20+20+60	1,36	1,36	4,08		6,80(2,00-8,50)	4,05	8,00	1,68	0,34	-2,38	840	7,70	1,70	1,70	5,10	8,50(3,20-10,60)	4,25	4,00	2,00	0,60	-2,78	1000	9,00	
20+25+25	1,94	2,43	2,43		6,80(1,90-8,00)	3,66	8,00	1,86	0,27	-2,41	930	8,40	2,42	3,04	3,04	8,50(3,30-10,40)	3,92	4,00	2,17	0,63	-2,92	1085	9,80	
20+25+35	1,69	2,13	2,98		6,80(1,90-8,00)	3,66	8,00	1,86	0,27	-2,32	930	8,40	2,12	2,66	3,72	8,50(3,30-10,40)	3,95	4,00	2,15	0,62	-2,85	1075	9,70	
20+25+42	1,56	1,95	3,29		6,80(1,90-8,10)	3,74	8,00	1,82	0,29	-2,42	910	8,20	1,95	2,44	4,11	8,50(3,30-10,50)	3,97	4,00	2,14	0,62	-2,89	1070	9,70	
20+25+50	1,43	1,79	3,58		6,80(2,00-8,50)	4,05	8,00	1,68	0,34	-2,38	840	7,70	1,79	2,24	4,47	8,50(3,20-10,60)	4,25	4,00	2,00	0,60	-2,78	1000	9,00	
20+25+60	1,29	1,62	3,89		6,80(2,00-8,50)	4,05	8,00	1,68	0,34	-2,38	840	7,70	1,62	2,02	4,86	8,50(3,20-10,60)	4,25	4,00	2,00	0,60	-2,78	1000	9,00	
20+35+35	1,52	2,64	2,64		6,80(1,90-8,10)	3,74	8,00	1,82	0,29	-2,33	910	8,20	1,88	3,31	3,31	8,50(3,30-10,50)	4,01	4,00	2,12	0,64	-2,87	1060	9,60	
20+35+42	1,40	2,45	2,95		6,80(1,90-8,20)	3,74	8,00	1,82	0,29	-2,42	910	8,20	1,75	3,07	3,68	8,50(3,30-10,50)	4,03	4,00	2,11	0,64	-2,86	1055	9,50	
20+35+50	1,29	2,27	3,24		6,80(2,00-8,50)	4,05	8,00	1,68	0,34	-2,33	840	7,70	1,62	2,83	4,05	8,50(3,20-10,60)	4,29	4,00	1,98	0,60	-2,76	990	9,00	
20+35+60	1,18	2,07	3,55		6,80(2,00-8,50)	4,05	8,00	1,68	0,34	-2,33	840	7,70	1,48	2,59	4,43	8,50(3,20-10,60)	4,29	4,00	1,98	0,60	-2,76	990	9,00	
20+42+42	1,30	2,75	2,75		6,80(1,90-8,20)	3,84	8,00	1,77	0,29	-2,37	885	8,00	1,64	3,43	3,43	8,50(3,30-10,50)	4,05	4,00	2,10	0,63	-2,86	1050	9,50	
20+42+50	1,21	2,55	3,04		6,80(2,00-8,50)	4,05	8,00	1,68	0,34	-2,33	840	7,70	1,52	3,19	3,79	8,50(3,20-10,60)	4,31	4,00	1,97	0,62	-2,75	985	8,90	
25+25+25	2,26	2,26	2,26		6,78(1,90-8,00)	3,65	8,00	1,86	0,27	-2,41	930	8,40	2,83	2,83	2,83	8,49(3,30-10,40)	3,91	4,00	2,17	0,63	-2,92	1085	9,80	
25+25+35	2,00	2,00	2,80		6,80(1,90-8,00)	3,66	8,00	1,86	0,27	-2,32	930	8,40	2,50	2,50	3,50	8,50(3,30-10,40)	3,95	4,00	2,15	0,62	-2,85	1075	9,70	
25+25+42	1,85	1,85	3,10		6,80(1,90-8,10)	3,74	8,00	1,82	0,29	-2,42	910	8,20	2,31	2,31	3,88	8,50(3,30-10,50)	3,97	4,00	2,14	0,62	-2,89	1070	9,70	
25+25+50	1,70	1,70	3,40		6,80(2,00-8,50)	4,05	8,00	1,68	0,34	-2,38	840	7,70	2,13	2,13	4,24	8,50(3,20-10,60)	4,25	4,00	2,00	0,60	-2,78	1000	9,00	
25+25+60	1,55	1,55	3,70		6,80(2,00-8,50)	4,05	8,00	1,68	0,34	-2,38	840	7,70	1,93	1,93	4,64	8,50(3,20-10,60)	4,25	4,00	2,00	0,60	-2,78	1000	9,00	
25+35+35	1,78	2,51	2,51		6,80(1,90-8,10)	3,74	8,00	1,82	0,29	-2,33	910	8,20	2,24	3,13	3,13	8,50(3,30-10,50)	4,01	4,00	2,12	0,64	-2,87	1060	9,60	
25+35+42	1,67	2,33	2,80		6,80(1,90-8,20)	3,74	8,00	1,82	0,29	-2,42	910	8,20	2,08	2,92	3,50	8,50(3,30-10,50)	4,03	4,00	2,11	0,64	-2,86	1055	9,50	
25+35+50	1,55	2,16	3,09		6,80(2,00-8,50)	4,05	8,00	1,68	0,34	-2,33	840	7,70	1,93	2,70	3,87	8,50(3,20-10,60)	4,29	4,00	1,98	0,60	-2,76	990	9,00	
25+42+42	1,56	2,62	2,62		6,80(1,90-8,20)	3,84	8,00	1,77	0,29	-2,37	885	8,00	1,94	3,28	3,28	8,50(3,30-10,50)	4,05	4,00	2,10	0,63	-2,86	1050	9,50	
35+35+35	2,26	2,26	2,26		6,78(1,90-8,20)	3,83	8,00	1,77	0,29	-2,33	885	8,00	2,83	2,83	2,83	8,49(3,30-10,50)	4,12	4,00	2,06	0,63	-2,85	1030	9,30	
35+35+42	2,13	2,13	2,54		6,80(1,90-8,20)	3,84	8,00	1,77	0,29	-2,33	885	8,00	2,66	2,66	3,18	8,50(3,30-10,50)	4,15	4,00	2,05	0,63	-2,80	1025	9,30	
4 Rooms																								
16+16+16+16	1,65	1,65	1,65	1,65	6,60(1,90-8,70)	4,49	8,50	1,47	0,34	-2,38	735	6,70	2,12	2,12	2,12	2,12	8,48(3,00-10,60)	4,44	4,20	1,91	0,58	-2,69	955	8,60
16+16+16+20	1,60	1,60	1,60	2,00	6,80(1,90-8,80)	4,39	8,00	1,55	0,34	-2,47	775	7,00	2,00	2,00	2,50	8,50(3,00-10,60)	4,47	4,20	1,90	0,58	-2,68	950	8,60	
16+16+16+25	1,49	1,49	1,49	2,33	6,80(1,90-8,80)	4,39	8,00	1,55	0,34	-2,47	775	7,00	1,86	1,86	1,86	2,92	8,50(3,00-10,60)	4,47	4,20	1,90	0,58	-2,68	950	8,60
16+16+16+35	1,31	1,31	1,31	2,87	6,80(1,90-8,80)	4,39	8,00	1,55	0,34	-2,38	775	7,00	1,64	1,64	1,64	3,58	8,50(3,00-10,60)	4,52	4,20	1,88	0,58	-2,66	940	8,50
16+16+16+42	1,21	1,21	1,21	3,17	6,80(1,90-8,80)	4,50	8,00	1,51	0,34	-2,38	755	6,80	1,51	1,51	1,51	3,97	8,50(3,00-10,60)	4,55	4,20	1,87	0,58	-2,65	935	8,50
16+16+16+50	1,11	1,11	1,11	3,47	6,80(1,90-8,80)	4,50	8,00	1,51	0,40	-2,24	755	6,80	1,39	1,39	1,39	4,33	8,50(3,00-10,60)	4,64	4,20	1,83	0,65	-2,55	915	8,30
16+16+16+60	1,01	1,01	1,01	3,77	6,80(1,90-8,80)	4,50	8,00	1,51	0,40	-2,24	755	6,80	1,26	1,26	1,26	4,72	8,50(3,00-10,60)	4,64	4,20	1,83	0,65	-2,55	915	8,30
16+16+20+20	1,51	1,51	1,89	1,89	6,80(1,90-8,80)	4,39	8,00	1,55	0,34	-2,43	775	7,00	1,89	1,89	2,36	2,36	8,50(3,10-10,60)	4,50	4,20	1,89	0,60	-2,67	945	8,50
16+16+20+25	1,41	1,41	1,77	2,21	6,80(1,90-8,80)	4,39	8,00	1,55	0,34	-2,43	775	7,00	1,77	1,77	2,20	2,76	8,50(3,10-10,60)	4,50	4,20	1,89	0,60	-2,67	945	8,50
16+16+20+35	1,25	1,25	1,56	2,74	6,80(1,90-8,80)	4,50	8,00	1,51	0,34	-2,38	755	6,80	1,56	1,56	1,95	3,43	8,50(3,00-10,60)	4,55	4,20	1,87	0,58	-2,65	935	8,50
16+16+20+42	1,16	1,16	1,44	3,04	6,80(1,90-8,80)	4,50	8,00	1,51	0,37	-2,38	755	6,80	1,45	1,45	1,80	3,80	8,50(3,00-10,60)	4,57	4,20	1,86	0,60	-2,64	930	8,40
16+16+20+50	1,07	1,07	1,33	3,33	6,80(1,90-8,80)	4,50	8,00	1,51	0,40	-2,20	755	6,80	1,33	1,33	1,67	4,17	8,50(3,00-10,60)	4,64	4,20	1,83	0,66	-2,54	915	8,30
16+16+20+60	0,97	0,97	1,21	3,65	6,80(1,90-8,80)	4,50	8,00	1,51	0,40	-2,20	755	6,80	1,21	1,21	1,52	4,56	8,50(3,00-10,60)	4,64	4,20	1,83	0,66	-2,54	915	8,30
16+16+25+25	1,33	1,33	2,07	2,07	6,80(1,90-8,80)	4,39	8,00	1,55	0,34	-2,43	775	7,00	1,66	1,66	2,59	2,59	8,50(3,10-10,60)	4,50	4,20	1,89	0,60	-2,67	945	8,50
16+16+25+35	1,18	1,18	1,85	2,59	6,80(1,90-8,80)	4,50	8,00	1,51	0,34	-2,38	755	6,80	1,48	1,48	2,31	3,23	8,50(3,00-10,60)	4,55	4,20	1,87	0,58	-2,65	935	8,50
16+16+25+42	1,10	1,10	1,72	2,88	6,80(1,90-8,80)	4,50	8,00	1,51	0,37	-2,38	755	6,80	1,37	1,37	2,15	3,61	8,50(3,00-10,60)	4,57	4,20	1,86	0,60	-2,64	930	8,40
16+16+25+50	1,																							

Free Multi 4x1 CU-4Z68TBE. Minimum capacity connected: 4,50 kW. Maximum capacity connected: 11,50 kW • R32 GAS

Indoor unit capacity	Cooling capacity (kW) Rooms					EER	SEER ¹	Input power rating	A.E.C. Current	Heating capacity (kW) Rooms					COP	SCOP ¹	Input power rating	A.E.C. Current		
	A	B	C	D	Total (Min - Max)					W/W	W/W	kW	kWh	230V					A	B
20+25+25+25	1,43	1,79	1,79	1,79	6,80(1,90-8,80)	4,39 A	8,00	1,55(0,34-2,38)	775	7,00	1,78	2,24	2,24	2,24	8,50(3,10-10,60)	4,52 A	4,20	1,88(0,60-2,66)	940	8,50
20+25+25+35	1,29	1,62	1,62	2,27	6,80(1,90-8,80)	4,50 A	8,00	1,51(0,37-2,33)	755	6,80	1,62	2,02	2,02	2,84	8,50(3,00-10,60)	4,57 A	4,20	1,86(0,61-2,63)	930	8,40
20+25+25+42	1,21	1,52	1,52	2,55	6,80(1,90-8,80)	4,50 A	8,00	1,51(0,37-2,33)	755	6,80	1,51	1,90	1,90	3,19	8,50(3,00-10,60)	4,59 A	4,20	1,85(0,61-2,62)	925	8,40
20+25+35+35	1,18	1,48	2,07	2,07	6,80(1,90-8,80)	4,50 A	8,00	1,51(0,37-2,33)	755	6,80	1,47	1,85	2,59	2,59	8,50(3,00-10,60)	4,62 A	4,60	1,84(0,61-2,61)	920	8,30
25+25+25+25	1,70	1,70	1,70	1,70	6,80(1,90-8,80)	4,39 A	8,00	1,55(0,34-2,38)	775	7,00	2,12	2,12	2,12	2,12	8,48(3,10-10,60)	4,51 A	4,20	1,88(0,60-2,66)	940	8,50
25+25+25+35	1,55	1,55	1,55	2,15	6,80(1,90-8,80)	4,50 A	8,00	1,51(0,37-2,33)	755	6,80	1,93	1,93	1,93	2,71	8,50(3,00-10,60)	4,57 A	4,20	1,86(0,61-2,63)	930	8,40

¹ Energy Label Scale from A+++ to D.

Free Multi 4x1 CU-4Z80TBE. Minimum capacity connected: 4,50 kW. Maximum capacity connected: 14,70 kW • R32 GAS

Indoor unit capacity	Cooling capacity (kW) Rooms					EER	SEER ¹	Input power rating	A.E.C. Current	Heating capacity (kW) Rooms					COP	SCOP ¹	Input power rating	A.E.C. Current		
	A	B	C	D	Total (Min - Max)					W/W	W/W	kW	kWh	230V					A	B
1 Room																				
16	1,60				1,60(1,30-2,30)	4,00 A		0,40(0,25-0,64)	200	2,00	2,60				2,60(1,20-3,20)	4,33 A		0,60(0,30-0,96)	300	3,00
20	2,00				2,00(1,80-2,90)	4,00 A		0,50(0,34-0,81)	250	2,50	3,20				3,20(1,20-4,10)	4,32 A		0,74(0,30-1,23)	370	3,70
25	2,50				2,50(1,80-2,90)	3,97 A		0,63(0,34-0,81)	315	3,20	3,60				3,60(1,20-4,30)	3,83 A		0,94(0,30-1,23)	470	4,70
35	3,50				3,50(1,80-4,10)	3,72 A		0,94(0,34-1,36)	470	4,50	4,50				4,50(1,20-5,80)	3,66 A		1,23(0,30-2,10)	615	6,00
42	4,20				4,20(1,80-4,50)	3,07 B		1,37(0,34-1,99)	685	6,40	5,60				5,60(1,20-6,80)	3,26 C		1,72(0,30-2,93)	860	8,00
50	5,00				5,00(1,90-5,70)	3,23 A		1,55(0,34-2,13)	775	7,20	6,80				6,80(1,20-6,90)	3,24 C		2,10(0,30-2,52)	1050	9,70
60	6,00				6,00(1,90-6,20)	2,96 C		2,03(0,34-2,33)	1015	9,20	8,50				8,50(1,30-9,00)	3,54 B		2,40(0,62-2,55)	1200	11,10
71	7,10				7,10(2,00-7,20)	2,81 C		2,53(0,37-2,77)	1265	11,40	8,70				8,70(1,40-9,20)	3,41 B		2,55(0,68-2,72)	1275	11,80
2 Rooms																				
16+16	1,60	1,60			3,20(2,40-5,80)	4,38 A	5,60	0,73(0,38-1,99)	365	3,70	2,60	2,60			5,20(2,20-8,20)	3,33 C	3,90	1,56(0,43-2,84)	780	7,40
16+20	1,60	2,00			3,60(2,40-5,80)	4,14 A	5,60	0,87(0,38-1,99)	435	4,30	2,58	3,22			5,80(2,20-8,20)	3,45 B	3,90	1,68(0,43-2,83)	840	8,00
16+25	1,60	2,50			4,10(2,40-5,80)	3,83 A	5,60	1,07(0,38-1,99)	535	5,20	2,42	3,78			6,20(2,20-8,20)	3,41 B	3,90	1,82(0,43-2,83)	910	8,60
16+35	1,60	3,50			5,10(2,40-5,80)	3,45 A	5,60	1,48(0,37-1,92)	740	7,20	2,23	4,87			7,10(2,20-8,60)	3,57 B	3,90	1,99(0,38-2,91)	995	9,40
16+42	1,60	4,20			5,80(2,40-6,70)	3,19 B	5,60	1,82(0,37-2,48)	910	8,70	2,26	5,94			8,20(2,20-9,80)	3,46 B	3,90	2,37(0,37-3,44)	1185	11,10
16+50	1,60	5,00			6,60(2,40-7,20)	3,20 A	6,10	2,06(0,35-2,48)	1030	9,90	2,28	7,12			9,40(2,20-10,00)	3,82 A	4,10	2,46(0,33-3,25)	1230	11,60
16+60	1,60	6,00			7,60(2,40-8,50)	2,83 C	6,10	2,69(0,35-3,49)	1345	12,90	1,98	7,42			9,40(2,20-10,00)	3,82 A	4,10	2,46(0,33-3,25)	1230	11,60
16+71	1,47	6,53			8,00(2,50-8,50)	2,82 C	6,10	2,84(0,38-3,34)	1420	13,60	1,73	7,67			9,40(2,20-10,30)	3,92 A	4,10	2,40(0,32-3,42)	1200	11,30
20+20	2,00	2,00			4,00(2,40-5,80)	3,96 A	5,60	1,01(0,38-1,93)	505	5,00	3,20	3,20			6,40(2,20-8,20)	3,44 B	3,90	1,86(0,39-2,82)	930	8,70
20+25	2,00	2,50			4,50(2,40-5,80)	3,63 A	5,60	1,24(0,38-1,93)	620	6,00	3,02	3,78			6,80(2,20-8,20)	3,54 B	3,90	1,92(0,39-2,82)	960	9,00
20+35	2,00	3,50			5,50(2,40-5,80)	3,33 A	5,60	1,65(0,37-1,86)	825	8,00	2,80	4,90			7,70(2,20-8,60)	3,55 B	3,90	2,57(0,37-2,85)	1085	10,20
20+42	2,00	4,20			6,20(2,40-7,20)	3,00 C	5,60	2,07(0,37-2,90)	1035	9,90	2,84	5,96			8,80(2,20-10,00)	3,64 A	3,90	2,42(0,37-3,55)	1210	11,40
20+50	2,00	5,00			7,00(2,40-8,10)	3,17 B	6,10	2,21(0,35-3,10)	1105	10,60	2,69	6,71			9,40(2,20-10,00)	3,84 A	4,10	2,45(0,32-3,23)	1225	11,50
20+60	2,00	6,00			8,00(2,40-8,50)	2,75 D	6,10	2,91(0,35-3,49)	1455	13,90	2,35	7,05			9,40(2,20-10,00)	3,84 A	4,10	2,45(0,32-3,23)	1225	11,50
20+71	1,76	6,24			8,00(2,50-8,50)	2,89 C	6,10	2,77(0,38-3,34)	1385	13,30	2,07	7,33			9,40(2,20-10,30)	3,93 A	4,10	2,39(0,32-3,40)	1195	11,20
25+25	2,50	2,50			5,00(2,40-5,80)	3,50 A	5,60	1,43(0,38-1,93)	715	6,90	3,60	3,60			7,20(2,20-8,60)	3,51 B	3,90	2,05(0,39-2,93)	1025	9,60
25+35	2,50	3,50			6,00(2,40-6,70)	3,09 B	5,60	1,94(0,37-2,48)	970	9,30	3,37	4,73			8,10(2,20-9,80)	3,49 B	3,90	2,32(0,37-3,44)	1160	10,90
25+42	2,50	4,20			6,70(2,40-7,20)	2,78 D	5,60	2,41(0,37-2,90)	1205	11,50	3,43	5,77			9,20(2,20-10,00)	3,58 B	3,90	2,57(0,37-3,55)	1285	12,10
25+50	2,50	5,00			7,50(2,40-8,50)	2,94 C	6,10	2,55(0,35-3,49)	1275	12,20	3,13	6,27			9,40(2,20-10,00)	3,84 A	4,10	2,45(0,32-3,23)	1225	11,50
25+60	2,35	5,65			8,00(2,50-8,50)	2,75 D	6,10	2,91(0,39-3,49)	1455	13,90	2,76	6,64			9,40(2,20-10,00)	3,84 A	4,10	2,45(0,32-3,23)	1225	11,50
25+71	2,08	5,92			8,00(2,50-8,50)	2,89 C	6,10	2,77(0,38-3,34)	1385	13,30	2,45	6,95			9,40(2,20-10,30)	3,93 A	4,10	2,39(0,32-3,40)	1195	11,20
35+35	3,50	3,50			7,00(2,40-8,10)	2,75 D	6,10	2,55(0,37-3,63)	1275	12,20	4,50	4,50			9,00(2,20-10,00)	3,67 A	3,90	2,45(0,36-3,47)	1225	11,50
35+42	3,50	4,20			7,70(2,40-8,50)	2,53 E	5,60	3,04(0,37-4,12)	1520	14,60	4,27	5,13			9,40(2,20-10,00)	3,63 A	3,90	2,59(0,35-3,46)	1295	12,20
35+50	3,29	4,71			8,00(2,50-8,50)	2,89 C	6,10	2,77(0,38-3,34)	1385	13,30	3,87	5,53			9,40(2,20-10,00)	3,95 A	4,10	2,38(0,32-3,20)	1190	11,20
35+60	2,95	5,05			8,00(2,50-8,50)	2,89 C	6,10	2,77(0,38-3,34)	1385	13,30	3,46	5,94			9,40(2,20-10,30)	3,95 A	4,10	2,38(0,32-3,32)	1190	11,20
35+71	2,64	5,36			8,00(2,50-8,60)	2,96 C	6,10	2,70(0,38-3,34)	1350	12,90	3,10	6,30			9,40(2,20-10,50)	3,98 A	4,10	2,36(0,31-3,43)	1180	11,10
42+42	4,00	4,00			8,00(2,50-8,50)	2,40 F	5,60	3,34(0,40-4,04)	1670	16,00	4,70	4,70			9,40(2,20-10,00)	3,64 A	3,90	2,58(0,35-3,45)	1290	12,10
42+50	3,65	4,35			8,00(2,50-8,50)	2,89 C	6,10	2,77(0,38-3,34)	1385	13,30	4,29	5,11			9,40(2,20-10,30)	3,98 A	4,10	2,36(0,32-3,31)	1180	11,10
42+60	3,29	4,71			8,00(2,50-8,60)	2,89 C	6,10	2,77(0,38-3,42)	1385	13,30	3,87	5,53			9,40(2,20-10,30)	3,98 A	4,10	2,36(0,32-3,31)	1180	11,10
42+71	2,97	5,03			8,00(2,50-8,60)	2,96 C	6,10	2,70(0,38-3,26)	1350	12,90	3,49	5,91			9,40(2,20-10,50)	4,00 A	4,10	2,35(0,31-3,42)	1175	11,00
50+50	4,00	4,00			8,00(2,50-8,60)	3,31 A	6,10	2,42(0,38-2,95)	1210	11,60	4,70	4,70			9,40(2,20-10,30)	4,27 A	4,10	2,20(0,31-3,09)	1100	10,30
50+60	3,64	4,36			8,00(2,50-8,60)	3,31 A	6,10	2,42(0,38-2,95)	1210	11,60	4,27	5,13			9,40(2,20-10,50)	4,27 A	4,10	2,20(0,31-3,15)	1100	10,30
50+71	3,31	4,69			8,00(2,50-8,60)	3,40 A	6,10	2,35(0,38-2,88)	1175	11,20	3,88	5,52			9,40(2,20-10,50)	4,31 A	4,10	2,18(0,31-3,13)		

FREE MULTI R32 COMBINATIONS TABLE

Free Multi 4x1 CU-4Z80TBE. Minimum capacity connected: 4,50 kW. Maximum capacity connected: 14,70 kW • R32 GAS

Indoor unit capacity	Cooling capacity (kW) Rooms							EER	SEER¹	Input power rating kW	A.E.C. Current			Heating capacity (kW) Rooms							COP	SCOP¹	Input power rating kW	A.E.C. Current		
	A	B	C	D	Total (Min - Max)	W/W	W/W				kWh	230V	A	B	C	D	Total (Min - Max)	W/W	W/W	kWh				kWh	230V	
16+25+25	1,60	2,50	2,50		6,60(3,00-8,50)	3,69	7,40	1,79(0,49-3,03)	895	8,60	2,28	3,56	3,56	9,40(3,20-10,40)	4,14	4,30	2,27(0,49-3,25)	1135	10,70							
16+25+35	1,60	2,50	3,50		7,60(3,00-8,50)	3,47	7,40	2,19(0,48-2,95)	1095	10,50	1,98	3,09	4,33	9,40(3,20-10,40)	4,20	4,30	2,24(0,49-3,21)	1120	10,50							
16+25+42	1,54	2,41	4,05		8,00(3,00-8,60)	3,49	7,40	2,29(0,48-3,03)	1145	11,00	1,81	2,83	4,76	9,40(3,20-10,40)	4,22	4,40	2,23(0,49-3,20)	1115	10,50							
16+25+50	1,41	2,20	4,39		8,00(3,00-8,60)	3,81	7,40	2,10(0,52-2,73)	1050	10,10	1,65	2,58	5,17	9,40(3,20-10,50)	4,43	4,40	2,12(0,51-3,05)	1060	10,00							
16+25+60	1,27	1,98	4,75		8,00(3,00-8,80)	3,81	7,40	2,10(0,52-2,80)	1050	10,10	1,49	2,33	5,58	9,40(3,20-10,50)	4,43	4,40	2,12(0,51-3,05)	1060	10,00							
16+25+71	1,14	1,79	5,07		8,00(3,00-8,80)	3,92	7,40	2,04(0,52-2,80)	1020	9,80	1,34	2,10	5,96	9,40(3,20-10,60)	4,45	4,40	2,11(0,51-3,09)	1055	9,90							
16+35+35	1,48	3,26	3,26		8,00(3,00-8,60)	3,59	7,40	2,23(0,48-2,95)	1115	10,70	1,74	3,83	3,83	9,40(3,20-10,50)	4,25	4,40	2,21(0,48-3,24)	1105	10,40							
16+35+42	1,38	3,01	3,61		8,00(3,00-8,60)	3,59	7,40	2,23(0,48-2,95)	1115	10,70	1,62	3,54	4,24	9,40(3,20-10,50)	4,27	4,40	2,20(0,48-3,16)	1100	10,30							
16+35+50	1,27	2,77	3,96		8,00(3,00-8,80)	3,92	7,40	2,04(0,52-2,80)	1020	9,80	1,49	3,26	4,65	9,40(3,20-10,50)	4,50	4,40	2,09(0,51-3,01)	1045	9,80							
16+35+60	1,15	2,52	4,33		8,00(3,00-8,80)	3,92	7,40	2,04(0,52-2,80)	1020	9,80	1,35	2,96	5,09	9,40(3,20-10,60)	4,50	4,40	2,09(0,51-3,07)	1045	9,80							
16+35+71	1,05	2,30	4,65		8,00(3,00-9,00)	3,92	7,40	2,04(0,52-2,87)	1020	9,80	1,23	2,70	5,47	9,40(3,20-10,60)	4,52	4,40	2,08(0,51-3,06)	1040	9,80							
16+42+42	1,28	3,36	3,36		8,00(3,00-8,80)	3,92	7,40	2,23(0,48-3,10)	1115	10,70	1,50	3,95	3,95	9,40(3,20-10,50)	4,29	4,40	2,19(0,48-3,15)	1095	10,30							
16+42+50	1,19	3,11	3,70		8,00(3,00-8,80)	3,92	7,40	2,04(0,52-2,80)	1020	9,80	1,39	3,66	4,35	9,40(3,20-10,50)	4,50	4,40	2,09(0,51-3,00)	1045	9,80							
16+42+60	1,08	2,85	4,07		8,00(3,00-9,00)	3,92	7,40	2,04(0,52-2,87)	1020	9,80	1,27	3,35	4,78	9,40(3,20-10,60)	4,50	4,40	2,09(0,51-3,06)	1045	9,80							
16+42+71	0,99	2,60	4,41		8,00(3,00-9,00)	4,04	7,40	1,98(0,52-2,80)	990	9,50	1,17	3,05	5,17	9,40(3,20-10,60)	4,54	4,40	2,07(0,51-3,04)	1035	9,70							
16+50+50	1,10	3,45	3,45		8,00(3,00-8,80)	4,17	7,40	1,92(0,57-2,58)	960	9,20	1,30	4,05	4,05	9,40(3,20-10,60)	4,70	4,40	2,00(0,57-2,93)	1000	9,40							
16+50+60	1,02	3,17	3,81		8,00(3,00-9,00)	4,17	7,40	1,92(0,57-2,65)	960	9,20	1,19	3,73	4,48	9,40(3,20-10,60)	4,70	4,40	2,00(0,57-2,93)	1000	9,40							
16+50+71	0,93	2,92	4,15		8,00(3,00-9,00)	4,17	7,40	1,92(0,57-2,65)	960	9,20	1,10	3,43	4,87	9,40(3,20-10,60)	4,72	4,40	1,99(0,59-2,92)	995	9,40							
16+60+60	0,94	3,53	3,53		8,00(3,00-9,00)	4,17	7,40	1,92(0,57-2,65)	960	9,20	1,10	4,15	4,15	9,40(3,20-10,60)	4,70	4,40	2,00(0,57-2,93)	1000	9,40							
16+60+71	0,87	3,27	3,86		8,00(3,00-9,00)	4,17	7,40	1,92(0,57-2,65)	960	9,20	1,02	3,84	4,54	9,40(3,20-10,60)	4,72	4,40	1,99(0,59-2,92)	995	9,40							
20+20+20	2,00	2,00	2,00		6,00(3,00-8,50)	4,00	7,40	1,50(0,48-3,03)	750	7,30	3,13	3,13	3,13	9,39(3,20-10,40)	4,15	4,30	2,26(0,49-3,24)	1130	10,60							
20+20+25	2,00	2,00	2,50		6,50(3,00-8,50)	3,76	7,40	1,73(0,48-3,03)	865	8,40	2,89	2,89	3,62	9,40(3,20-10,40)	4,16	4,30	2,26(0,49-3,24)	1130	10,60							
20+20+35	2,00	2,00	3,50		7,50(3,00-8,50)	3,64	7,40	2,06(0,48-2,95)	1030	9,90	2,51	2,51	4,38	9,40(3,20-10,40)	4,22	4,30	2,23(0,49-3,20)	1115	10,50							
20+20+42	1,95	1,95	4,10		8,00(3,00-8,60)	3,49	7,40	2,29(0,48-3,03)	1145	11,00	2,29	2,29	4,82	9,40(3,20-10,40)	4,23	4,40	2,22(0,48-3,17)	1110	10,40							
20+20+50	1,78	1,78	4,44		8,00(3,00-8,60)	3,92	7,40	2,04(0,52-2,65)	1020	9,80	2,09	2,09	5,22	9,40(3,20-10,50)	4,45	4,40	2,11(0,51-3,03)	1055	9,90							
20+20+60	1,60	1,60	4,80		8,00(3,00-8,80)	3,92	7,40	2,04(0,52-2,80)	1020	9,80	1,88	1,88	5,64	9,40(3,20-10,50)	4,45	4,40	2,11(0,51-3,03)	1055	9,90							
20+20+71	1,44	1,44	5,12		8,00(3,00-8,80)	3,92	7,40	2,04(0,52-2,72)	1020	9,80	1,69	1,69	6,02	9,40(3,20-10,60)	4,48	4,40	2,10(0,51-3,08)	1050	9,90							
20+25+25	2,00	2,50	2,50		7,00(3,00-8,50)	3,70	7,40	1,89(0,48-3,30)	945	9,00	2,68	3,36	3,36	9,40(3,20-10,40)	4,16	4,30	2,26(0,49-3,24)	1130	10,60							
20+25+35	2,00	2,50	3,50		8,00(3,00-8,60)	3,49	7,40	2,29(0,48-3,03)	1145	11,00	2,35	2,94	4,11	9,40(3,20-10,40)	4,22	4,40	2,23(0,49-3,20)	1115	10,50							
20+25+42	1,84	2,30	3,86		8,00(3,00-8,60)	3,49	7,40	2,29(0,48-3,03)	1145	11,00	2,16	2,70	4,54	9,40(3,20-10,50)	4,23	4,40	2,22(0,48-3,25)	1110	10,40							
20+25+50	1,68	2,11	4,21		8,00(3,00-8,60)	3,92	7,40	2,04(0,52-2,65)	1020	9,80	1,98	2,47	4,95	9,40(3,20-10,50)	4,45	4,40	2,11(0,51-3,03)	1055	9,90							
20+25+60	1,52	1,90	4,58		8,00(3,00-8,80)	3,92	7,40	2,04(0,52-2,80)	1020	9,80	1,79	2,24	5,37	9,40(3,20-10,50)	4,45	4,40	2,11(0,51-3,03)	1055	9,90							
20+25+71	1,38	1,72	4,90		8,00(3,00-8,80)	3,92	7,40	2,04(0,52-2,72)	1020	9,80	1,62	2,03	5,75	9,40(3,20-10,60)	4,48	4,40	2,10(0,51-3,08)	1050	9,90							
20+35+35	1,78	3,11	3,11		8,00(3,00-8,60)	3,59	7,40	2,23(0,48-2,95)	1115	10,70	2,08	3,66	3,66	9,40(3,20-10,50)	4,27	4,40	2,20(0,48-3,16)	1100	10,30							
20+35+42	1,65	2,89	3,46		8,00(3,00-8,60)	3,59	7,40	2,23(0,48-2,95)	1115	10,70	1,94	3,39	4,07	9,40(3,20-10,50)	4,29	4,40	2,19(0,48-3,15)	1095	10,30							
20+35+50	1,52	2,67	3,81		8,00(3,00-8,80)	3,92	7,40	2,04(0,52-2,80)	1020	9,80	1,79	3,13	4,48	9,40(3,20-10,50)	4,50	4,40	2,09(0,51-3,00)	1045	9,80							
20+35+60	1,39	2,43	4,18		8,00(3,00-8,80)	3,92	7,40	2,04(0,52-2,80)	1020	9,80	1,63	2,86	4,91	9,40(3,20-10,60)	4,50	4,40	2,09(0,51-3,06)	1045	9,80							
20+35+71	1,27	2,22	4,51		8,00(3,00-9,00)	4,04	7,40	1,98(0,52-2,80)	990	9,50	1,49	2,61	5,30	9,40(3,20-10,60)	4,54	4,40	2,07(0,51-3,04)	1035	9,70							
20+42+42	1,54	3,23	3,23		8,00(3,00-8,80)	3,59	7,40	2,23(0,48-3,03)	1115	10,70	1,80	3,80	3,80	9,40(3,20-10,50)	4,31	4,40	2,18(0,48-3,14)	1090	10,20							
20+42+50	1,43	3,00	3,57		8,00(3,00-8,80)	3,92	7,40	2,04(0,52-2,72)	1020	9,80	1,68	3,53	4,19	9,40(3,20-10,60)	4,52	4,40	2,08(0,51-3,05)	1040	9,80							
20+42+60	1,31	2,75	3,94		8,00(3,00-9,00)	3,92	7,40	2,04(0,52-2,87)	1020	9,80	1,54	3,24	4,62	9,40(3,20-10,60)	4,52	4,40	2,08(0,51-3,05)	1040	9,80							
20+42+71	1,20	2,53	4,27		8,00(3,00-9,00)	4,04	7,40	1,98(0,52-2,80)	990	9,50	1,41	2,97	5,02	9,40(3,20-10,60)	4,54	4,40	2,07(0,52-3,03)	1035	9,70							
20+50+50	1,33	3,33	3,33		7,99(3,00-9,00)	4,16	7,40	1,92(0,57-2,65)	960	9,20	1,56	3,92	3,92	9,40(3,20-10,60)	4,72	4,40	1,99(0,59-2,92)	995	9,40							
20+50+60	1,23	3,08	3,69		8,00(3,00-9,00)	4,17	7,40	1,92(0,57-2,65)	960	9,20	1,45	3,62	4,33	9,40(3,20-10,60)	4,72	4,40	1,99(0,59-2,92)	995	9,40							
20+50+71	1,13	2,84	4,03		8,00(3,00-9,00)	4,17	7,40	1,92(0,57-2,65)	960	9,20	1,33	3,33	4,74	9,40(3,20-10,60)	4,75	4,40	1,98(0,60-2,91)	990	9,30							
20+60+60	1,14	3,43	3,43		8,00(3,00-9,00)	4,17	7,40	1,92(0,57-2,65)	960	9,20	1,34	4,03	4,03	9,40(3,20-10,60)	4,72	4,40	1,99(0,59-2,92)	995	9,40							
25+25+25	2,50	2,50	2,50		7,50(3,00-8,50)	3,52	7,40	2,13(0,48-3,03)	1065	10,20	3,13	3,13	3,13	9,39(3,20-10,40)	4,15	4,30	2,26(0,49-3,24)	1130	10,60							
25+25+35	2,35	2,35	3,30		8,00(3,00-8,60)	3,49	7,40	2,29(0,48-3,03)	1145	11,00	2,76	2,76	3,88	9,40(3												

Free Multi 4x1 CU-4Z80TBE. Minimum capacity connected: 4,50 kW. Maximum capacity connected: 14,70 kW • R32 GAS

Indoor unit capacity	Cooling capacity (kW) Rooms					EER	SEER¹	Input power rating	A.E.C.	Current	Heating capacity (kW) Rooms					COP	SCOP¹	Input power rating	A.E.C.	Current
	A	B	C	D	Total (Min - Max)						W/W	W/W	kW	kWh	230V					
42+42+60	2,33	2,33	3,33		7,99 [3,00 - 9,00]	4,04	7,40	1,98 [0,52 - 2,80]	990	9,50	2,74	2,74	3,92		9,40 [3,20 - 10,60]	4,59	4,40	2,05 [0,54 - 3,00]	1025	9,60
42+50+50	2,36	2,82	2,82		8,00 [3,00 - 9,00]	4,17	7,40	1,92 [0,57 - 2,65]	960	9,20	2,78	3,31	3,31		9,40 [3,20 - 10,60]	4,77	4,40	1,97 [0,61 - 2,88]	985	9,30
4 Rooms																				
16+16+16+16	1,60	1,60	1,60	1,60	6,40 [3,00 - 9,20]	4,30	8,50	1,49 [0,52 - 2,95]	745	7,20	2,35	2,35	2,35	2,35	9,40 [4,20 - 10,60]	4,54	4,60	2,07 [0,68 - 3,03]	1035	9,70
16+16+16+20	1,60	1,60	1,60	2,00	6,80 [3,00 - 9,20]	4,28	8,50	1,59 [0,52 - 2,87]	795	7,70	2,21	2,21	2,21	2,77	9,40 [4,20 - 10,60]	4,56	4,60	2,06 [0,68 - 3,02]	1030	9,70
16+16+16+25	1,60	1,60	1,60	2,50	7,30 [3,00 - 9,20]	4,15	7,90	1,76 [0,52 - 2,87]	880	8,40	2,06	2,06	2,06	3,22	9,40 [4,20 - 10,60]	4,56	4,60	2,06 [0,68 - 3,02]	1030	9,70
16+16+16+35	1,54	1,54	1,54	3,38	8,00 [3,00 - 9,20]	4,04	7,90	1,98 [0,53 - 2,87]	990	9,50	1,81	1,81	1,81	3,97	9,40 [4,20 - 10,60]	4,61	4,70	2,04 [0,69 - 2,99]	1020	9,60
16+16+16+42	1,42	1,42	1,42	3,74	8,00 [3,00 - 9,20]	4,04	7,90	1,98 [0,53 - 2,87]	990	9,50	1,67	1,67	1,67	4,39	9,40 [4,20 - 10,60]	4,63	4,70	2,03 [0,69 - 2,98]	1015	9,50
16+16+16+50	1,31	1,31	1,31	4,07	8,00 [3,00 - 9,20]	4,28	7,90	1,87 [0,62 - 2,73]	935	9,00	1,53	1,53	1,53	4,81	9,40 [4,20 - 10,60]	4,70	4,70	2,00 [0,76 - 2,86]	1000	9,40
16+16+16+60	1,19	1,19	1,19	4,43	8,00 [3,00 - 9,20]	4,28	7,90	1,87 [0,62 - 2,73]	935	9,00	1,39	1,39	1,39	5,23	9,40 [4,20 - 10,60]	4,70	4,70	2,00 [0,76 - 2,86]	1000	9,40
16+16+16+71	1,08	1,08	1,08	4,76	8,00 [3,00 - 9,20]	4,28	7,90	1,87 [0,62 - 2,66]	935	9,00	1,26	1,26	1,26	5,62	9,40 [4,20 - 10,60]	4,72	4,70	1,99 [0,77 - 2,85]	995	9,40
16+16+20+20	1,60	1,60	2,00	2,00	7,20 [3,00 - 9,20]	4,24	7,90	1,70 [0,53 - 2,87]	850	8,20	2,09	2,09	2,61	2,61	9,40 [4,20 - 10,60]	4,59	4,60	2,05 [0,68 - 3,01]	1025	9,60
16+16+20+25	1,60	1,60	2,00	2,50	7,70 [3,00 - 9,20]	4,14	7,90	1,86 [0,53 - 2,87]	930	8,90	1,95	1,95	2,44	3,06	9,40 [4,20 - 10,60]	4,59	4,60	2,05 [0,68 - 3,01]	1025	9,60
16+16+20+35	1,47	1,47	1,84	3,22	8,00 [3,00 - 9,20]	4,17	7,90	1,92 [0,53 - 2,87]	960	9,20	1,73	1,73	2,16	3,78	9,40 [4,20 - 10,60]	4,63	4,70	2,03 [0,69 - 2,98]	1015	9,50
16+16+20+42	1,36	1,36	1,70	3,58	8,00 [3,00 - 9,20]	4,17	7,90	1,92 [0,56 - 2,87]	960	9,20	1,60	1,60	2,00	4,20	9,40 [4,20 - 10,60]	4,65	4,70	2,02 [0,71 - 2,97]	1010	9,50
16+16+20+50	1,25	1,25	1,57	3,93	8,00 [3,00 - 9,20]	4,28	7,90	1,87 [0,62 - 2,65]	935	9,00	1,47	1,47	1,84	4,62	9,40 [4,20 - 10,60]	4,72	4,70	1,99 [0,77 - 2,85]	995	9,40
16+16+20+60	1,14	1,14	1,43	4,29	8,00 [3,00 - 9,20]	4,28	7,90	1,87 [0,62 - 2,65]	935	9,00	1,34	1,34	1,68	5,04	9,40 [4,20 - 10,60]	4,72	4,70	1,99 [0,77 - 2,85]	995	9,40
16+16+20+71	1,04	1,04	1,30	4,62	8,00 [3,00 - 9,20]	4,28	7,90	1,87 [0,62 - 2,66]	935	9,00	1,22	1,22	1,53	5,43	9,40 [4,20 - 10,60]	4,75	4,70	1,98 [0,79 - 2,90]	990	9,40
16+16+25+25	1,56	1,56	2,44	2,44	8,00 [3,00 - 9,20]	4,04	7,90	1,98 [0,53 - 2,87]	990	9,50	1,83	1,83	2,87	2,87	9,40 [4,20 - 10,60]	4,59	4,70	2,05 [0,68 - 3,01]	1025	9,60
16+16+25+35	1,39	1,39	2,17	3,05	8,00 [3,00 - 9,20]	4,17	7,90	1,92 [0,53 - 2,87]	960	9,20	1,63	1,63	2,55	3,59	9,40 [4,20 - 10,60]	4,63	4,70	2,03 [0,69 - 2,98]	1015	9,50
16+16+25+42	1,29	1,29	2,02	3,40	8,00 [3,00 - 9,20]	4,17	7,90	1,92 [0,56 - 2,87]	960	9,20	1,52	1,52	2,37	3,99	9,40 [4,20 - 10,60]	4,65	4,70	2,02 [0,71 - 2,97]	1010	9,50
16+16+25+50	1,20	1,20	1,87	3,73	8,00 [3,00 - 9,20]	4,28	7,90	1,87 [0,62 - 2,65]	935	9,00	1,41	1,41	2,20	4,38	9,40 [4,20 - 10,60]	4,72	4,70	1,99 [0,77 - 2,85]	995	9,40
16+16+25+60	1,09	1,09	1,71	4,11	8,00 [3,00 - 9,20]	4,28	7,90	1,87 [0,62 - 2,65]	935	9,00	1,29	1,29	2,01	4,81	9,40 [4,20 - 10,60]	4,72	4,70	1,99 [0,77 - 2,85]	995	9,40
16+16+25+71	1,00	1,00	1,56	4,44	8,00 [3,00 - 9,20]	4,28	7,90	1,87 [0,62 - 2,66]	935	9,00	1,18	1,18	1,84	5,20	9,40 [4,20 - 10,60]	4,75	4,70	1,98 [0,79 - 2,90]	990	9,30
16+16+35+35	1,25	1,25	2,75	2,75	8,00 [3,00 - 9,20]	4,17	7,90	1,92 [0,57 - 2,80]	960	9,20	1,47	1,47	3,23	3,23	9,40 [4,20 - 10,60]	4,68	4,70	2,01 [0,72 - 2,95]	1005	9,40
16+16+35+42	1,17	1,17	2,57	3,09	8,00 [3,00 - 9,20]	4,17	7,90	1,92 [0,57 - 2,80]	960	9,20	1,38	1,38	3,02	3,62	9,40 [4,20 - 10,60]	4,70	4,70	2,00 [0,72 - 2,94]	1000	9,40
16+16+35+50	1,09	1,09	2,39	3,43	8,00 [3,00 - 9,20]	4,28	7,90	1,87 [0,62 - 2,66]	935	9,00	1,29	1,29	2,81	4,01	9,40 [4,20 - 10,60]	4,75	4,70	1,98 [0,80 - 2,89]	990	9,30
16+16+35+60	1,01	1,01	2,20	3,78	8,00 [3,00 - 9,20]	4,28	7,90	1,87 [0,62 - 2,66]	935	9,00	1,18	1,18	2,59	4,45	9,40 [4,20 - 10,60]	4,75	4,70	1,98 [0,80 - 2,89]	990	9,30
16+16+35+71	0,93	0,93	2,03	4,11	8,00 [3,00 - 9,20]	4,28	7,90	1,87 [0,63 - 2,66]	935	9,00	1,09	1,09	2,38	4,84	9,40 [4,20 - 10,60]	4,77	4,70	1,97 [0,80 - 2,87]	985	9,30
16+16+42+42	1,10	1,10	2,90	2,90	8,00 [3,00 - 9,20]	4,17	7,90	1,92 [0,57 - 2,80]	960	9,20	1,30	1,30	3,40	3,40	9,40 [4,20 - 10,60]	4,70	4,70	2,00 [0,72 - 2,93]	1000	9,40
16+16+42+50	1,03	1,03	2,71	3,23	8,00 [3,00 - 9,20]	4,28	7,90	1,87 [0,62 - 2,66]	935	9,00	1,21	1,21	3,18	3,80	9,40 [4,20 - 10,60]	4,77	4,70	1,97 [0,80 - 2,88]	985	9,30
16+16+42+60	0,96	0,96	2,51	3,57	8,00 [3,00 - 9,20]	4,28	7,90	1,87 [0,62 - 2,66]	935	9,00	1,12	1,12	2,95	4,21	9,40 [4,20 - 10,60]	4,77	4,70	1,97 [0,80 - 2,88]	985	9,30
16+16+42+71	0,88	0,88	2,32	3,92	8,00 [3,00 - 9,20]	4,28	7,90	1,87 [0,63 - 2,66]	935	9,00	1,04	1,04	2,72	4,60	9,40 [4,20 - 10,60]	4,77	4,70	1,97 [0,81 - 2,87]	985	9,30
16+16+50+50	0,97	0,97	3,03	3,03	8,00 [3,00 - 9,20]	4,26	7,90	1,88 [0,69 - 2,60]	940	9,00	1,14	1,14	3,56	3,56	9,40 [4,20 - 10,60]	4,68	4,70	2,01 [0,92 - 2,85]	1005	9,40
16+16+50+60	0,90	0,90	2,82	3,38	8,00 [3,00 - 9,20]	4,26	7,90	1,88 [0,69 - 2,60]	940	9,00	1,06	1,06	3,31	3,97	9,40 [4,20 - 10,60]	4,68	4,70	2,01 [0,92 - 2,85]	1005	9,40
16+20+20+20	1,60	2,00	2,00	2,00	7,60 [3,00 - 9,20]	4,06	7,90	1,87 [0,53 - 2,87]	850	8,20	1,99	2,47	2,47	2,47	9,40 [4,20 - 10,60]	4,61	4,60	2,04 [0,69 - 3,00]	1020	9,60
16+20+20+25	1,58	1,98	1,98	2,46	8,00 [3,00 - 9,20]	4,04	7,90	1,98 [0,53 - 2,87]	990	9,50	1,86	2,32	2,32	2,90	9,40 [4,20 - 10,60]	4,61	4,70	2,04 [0,69 - 3,00]	1020	9,60
16+20+20+35	1,41	1,76	1,76	3,07	8,00 [3,00 - 9,20]	4,17	7,90	1,92 [0,57 - 2,80]	960	9,20	1,65	2,07	2,07	3,61	9,40 [4,20 - 10,60]	4,65	4,70	2,02 [0,71 - 2,97]	1010	9,50
16+20+20+42	1,31	1,63	1,63	3,43	8,00 [3,00 - 9,20]	4,17	7,90	1,92 [0,57 - 2,80]	960	9,20	1,53	1,92	1,92	4,03	9,40 [4,20 - 10,60]	4,68	4,70	2,01 [0,71 - 2,96]	1005	9,40
16+20+20+50	1,21	1,51	1,51	3,77	8,00 [3,00 - 9,20]	4,28	7,90	1,87 [0,62 - 2,65]	935	9,00	1,42	1,77	1,77	4,44	9,40 [4,20 - 10,60]	4,72	4,70	1,99 [0,79 - 2,90]	995	9,40
16+20+20+60	1,10	1,38	1,38	4,14	8,00 [3,00 - 9,20]	4,28	7,90	1,87 [0,62 - 2,65]	935	9,00	1,30	1,62	1,62	4,86	9,40 [4,20 - 10,60]	4,72	4,70	1,99 [0,79 - 2,90]	995	9,40
16+20+20+71	1,01	1,26	1,26	4,47	8,00 [3,00 - 9,20]	4,28	7,90	1,87 [0,63 - 2,66]	935	9,00	1,18	1,48	1,48	5,26	9,40 [4,20 - 10,60]	4,75	4,70			

FREE MULTI R32 COMBINATIONS TABLE

Free Multi 4x1 CU-4Z80TBE. Minimum capacity connected: 4,50 kW. Maximum capacity connected: 14,70 kW • R32 GAS

Indoor unit capacity	Cooling capacity (kW) Rooms					EER	SEER ¹	Input power rating kW	A.E.C. kWh	Current 230V	Heating capacity (kW) Rooms					COP	SCOP ¹	Input power rating kW	A.E.C. kWh	Current 230V
	A	B	C	D	Total (Min- Max)						W/W	W/W	A	B	C					
16+35+42+42	0,95	2,07	2,49	2,49	8,00(3,00-9,20)	4,17	7,90	1,92(0,57-2,72)	960	9,20	1,11	2,45	2,92	2,92	9,40(4,20-10,60)	4,77	4,70	1,97(0,75-2,89)	985	9,30
16+35+42+50	0,90	1,96	2,35	2,79	8,00(3,00-9,20)	4,28	7,90	1,87(0,63-2,66)	935	9,00	1,05	2,30	2,76	3,29	9,40(4,20-10,60)	4,70	4,70	2,00(0,84-2,85)	1000	9,40
16+42+42+42	0,89	2,37	2,37	2,37	8,00(3,00-9,20)	4,17	7,90	1,92(0,57-2,72)	960	9,20	1,06	2,78	2,78	2,78	9,40(4,20-10,60)	4,77	4,70	1,97(0,76-2,88)	985	9,30
20+20+20+20	2,00	2,00	2,00	2,00	8,00(3,00-9,20)	4,04	7,90	1,98(0,53-2,87)	990	9,50	2,35	2,35	2,35	2,35	9,40(4,20-10,60)	4,63	4,70	2,03(0,69-2,99)	1015	9,50
20+20+20+25	1,88	1,88	1,88	2,36	8,00(3,00-9,20)	4,04	7,90	1,98(0,53-2,87)	990	9,50	2,21	2,21	2,21	2,77	9,40(4,20-10,60)	4,63	4,70	2,03(0,69-2,99)	1015	9,50
20+20+20+35	1,68	1,68	1,68	2,96	8,00(3,00-9,20)	4,17	7,90	1,92(0,57-2,80)	960	9,20	1,98	1,98	1,98	3,46	9,40(4,20-10,60)	4,68	4,70	2,01(0,71-2,96)	1005	9,40
20+20+20+42	1,57	1,57	1,57	3,29	8,00(3,00-9,20)	4,17	7,90	1,92(0,57-2,80)	960	9,20	1,84	1,84	1,84	3,88	9,40(4,20-10,60)	4,68	4,70	2,01(0,72-2,95)	1005	9,40
20+20+20+50	1,45	1,45	1,45	3,65	8,00(3,00-9,20)	4,28	7,90	1,87(0,62-2,65)	935	9,00	1,71	1,71	1,71	4,27	9,40(4,20-10,60)	4,75	4,70	1,98(0,80-2,89)	990	9,30
20+20+20+60	1,33	1,33	1,33	4,01	8,00(3,00-9,20)	4,28	7,90	1,87(0,62-2,65)	935	9,00	1,57	1,57	1,57	4,69	9,40(4,20-10,60)	4,75	4,70	1,98(0,80-2,89)	990	9,30
20+20+20+71	1,22	1,22	1,22	4,34	8,00(3,00-9,20)	4,28	7,90	1,87(0,63-2,66)	935	9,00	1,44	1,44	1,44	5,08	9,40(4,20-10,60)	4,77	4,70	1,97(0,80-2,88)	985	9,30
20+20+25+25	1,78	1,78	2,22	2,22	8,00(3,00-9,20)	4,04	7,90	1,98(0,53-2,87)	990	9,50	2,09	2,09	2,61	2,61	9,40(4,20-10,60)	4,63	4,70	2,03(0,69-2,99)	1015	9,50
20+20+25+35	1,60	1,60	2,00	2,80	8,00(3,00-9,20)	4,17	7,90	1,92(0,57-2,80)	960	9,20	1,88	1,88	2,35	2,29	9,40(4,20-10,60)	4,68	4,70	2,01(0,71-2,96)	1005	9,40
20+20+25+42	1,50	1,50	1,87	3,13	8,00(3,00-9,20)	4,17	7,90	1,92(0,57-2,80)	960	9,20	1,76	1,76	2,20	3,68	9,40(4,20-10,60)	4,68	4,70	2,01(0,72-2,95)	1005	9,40
20+20+25+50	1,39	1,39	1,74	3,48	8,00(3,00-9,20)	4,28	7,90	1,87(0,62-2,65)	935	9,00	1,63	1,63	2,04	4,10	9,40(4,20-10,60)	4,75	4,70	1,98(0,80-2,89)	990	9,30
20+20+25+60	1,28	1,28	1,60	3,84	8,00(3,00-9,20)	4,28	7,90	1,87(0,62-2,65)	935	9,00	1,50	1,50	1,88	4,52	9,40(4,20-10,60)	4,75	4,70	1,98(0,80-2,89)	990	9,30
20+20+25+71	1,18	1,18	1,47	4,17	8,00(3,00-9,20)	4,28	7,90	1,87(0,63-2,66)	935	9,00	1,38	1,38	1,73	4,91	9,40(4,20-10,60)	4,77	4,70	1,97(0,80-2,88)	985	9,30
20+20+35+35	1,45	1,45	2,55	2,55	8,00(3,00-9,20)	4,17	7,90	1,92(0,57-2,80)	960	9,20	1,71	1,71	2,99	2,99	9,40(4,20-10,60)	4,70	4,70	2,00(0,72-2,93)	1000	9,40
20+20+35+42	1,37	1,37	2,39	2,87	8,00(3,00-9,20)	4,17	7,90	1,92(0,57-2,80)	960	9,20	1,61	1,61	2,81	3,37	9,40(4,20-10,60)	4,72	4,70	1,99(0,72-2,92)	995	9,40
20+20+35+50	1,28	1,28	2,24	3,20	8,00(3,00-9,20)	4,28	7,90	1,87(0,63-2,66)	935	9,00	1,50	1,50	2,63	3,77	9,40(4,20-10,60)	4,77	4,70	1,97(0,81-2,87)	985	9,30
20+20+35+60	1,19	1,19	2,07	3,55	8,00(3,00-9,20)	4,28	7,90	1,87(0,63-2,66)	935	9,00	1,39	1,39	2,44	4,18	9,40(4,20-10,60)	4,77	4,70	1,97(0,81-2,87)	985	9,30
20+20+35+71	1,10	1,10	1,92	3,88	8,00(3,00-9,20)	4,28	7,90	1,87(0,63-2,66)	935	9,00	1,29	1,29	2,25	4,57	9,40(4,20-10,60)	4,70	4,70	2,00(0,83-2,86)	1000	9,40
20+20+42+42	1,29	1,29	2,71	2,71	8,00(3,00-9,20)	4,17	7,90	1,92(0,57-2,80)	960	9,20	1,52	1,52	3,18	3,18	9,40(4,20-10,60)	4,75	4,70	1,98(0,80-2,91)	990	9,30
20+20+42+50	1,21	1,21	2,55	3,03	8,00(3,00-9,20)	4,28	7,90	1,87(0,63-2,66)	935	9,00	1,42	1,42	2,99	3,57	9,40(4,20-10,60)	4,70	4,70	2,00(0,81-2,86)	1000	9,40
20+20+42+60	1,13	1,13	2,37	3,37	8,00(3,00-9,20)	4,28	7,90	1,87(0,63-2,66)	935	9,00	1,32	1,32	2,78	3,98	9,40(4,20-10,60)	4,70	4,70	2,00(0,81-2,86)	1000	9,40
20+20+50+50	1,14	1,14	2,86	2,86	8,00(3,00-9,20)	4,23	7,90	1,89(0,70-2,60)	945	9,00	1,34	1,34	3,36	3,36	9,40(4,20-10,60)	4,68	4,70	2,01(0,94-2,89)	1005	9,40
20+25+25+25	1,67	2,11	2,11	2,11	8,00(3,00-9,20)	4,04	7,90	1,98(0,53-2,87)	990	9,50	1,99	2,47	2,47	2,47	9,40(4,20-10,60)	4,63	4,70	2,03(0,69-2,99)	1015	9,50
20+25+25+35	1,52	1,90	1,90	2,68	8,00(3,00-9,20)	4,17	7,90	1,92(0,57-2,80)	960	9,20	1,79	2,24	2,24	3,13	9,40(4,20-10,60)	4,68	4,70	2,01(0,71-2,96)	1005	9,40
20+25+25+42	1,43	1,79	1,79	2,99	8,00(3,00-9,20)	4,17	7,90	1,92(0,57-2,80)	960	9,20	1,68	2,10	2,10	3,52	9,40(4,20-10,60)	4,68	4,70	2,01(0,72-2,95)	1005	9,40
20+25+25+50	1,33	1,67	1,67	3,33	8,00(3,00-9,20)	4,28	7,90	1,87(0,62-2,65)	935	9,00	1,57	1,96	1,96	3,91	9,40(4,20-10,60)	4,75	4,70	1,98(0,80-2,89)	990	9,30
20+25+25+60	1,23	1,54	1,54	3,69	8,00(3,00-9,20)	4,28	7,90	1,87(0,62-2,65)	935	9,00	1,45	1,81	1,81	4,33	9,40(4,20-10,60)	4,75	4,70	1,98(0,80-2,89)	990	9,30
20+25+25+71	1,13	1,42	1,42	4,03	8,00(3,00-9,20)	4,28	7,90	1,87(0,63-2,66)	935	9,00	1,33	1,67	1,67	4,73	9,40(4,20-10,60)	4,77	4,70	1,97(0,80-2,88)	985	9,30
20+25+35+35	1,39	1,75	2,43	2,43	8,00(3,00-9,20)	4,17	7,90	1,92(0,57-2,80)	960	9,20	1,63	2,05	2,86	2,86	9,40(4,20-10,60)	4,70	4,70	2,00(0,72-2,93)	1000	9,40
20+25+35+42	1,31	1,64	2,30	2,75	8,00(3,00-9,20)	4,17	7,90	1,92(0,57-2,80)	960	9,20	1,54	1,93	2,70	3,23	9,40(4,20-10,60)	4,72	4,70	1,99(0,72-2,92)	995	9,40
20+25+35+50	1,23	1,54	2,15	3,08	8,00(3,00-9,20)	4,28	7,90	1,87(0,63-2,66)	935	9,00	1,45	1,81	2,53	3,61	9,40(4,20-10,60)	4,77	4,70	1,97(0,81-2,87)	985	9,30
20+25+35+60	1,14	1,43	2,00	3,43	8,00(3,00-9,20)	4,28	7,90	1,87(0,63-2,66)	935	9,00	1,34	1,68	2,35	4,03	9,40(4,20-10,60)	4,77	4,70	1,97(0,81-2,87)	985	9,30
20+25+42+42	1,24	1,56	2,60	2,60	8,00(3,00-9,20)	4,17	7,90	1,92(0,57-2,80)	960	9,20	1,46	1,82	3,06	3,06	9,40(4,20-10,60)	4,75	4,70	1,98(0,72-2,91)	990	9,30
20+25+42+50	1,17	1,46	2,45	2,92	8,00(3,00-9,20)	4,28	7,90	1,87(0,63-2,66)	935	9,00	1,37	1,72	2,88	3,43	9,40(4,20-10,60)	4,70	4,70	2,00(0,81-2,86)	1000	9,40
20+25+42+60	1,09	1,36	2,29	3,26	8,00(3,00-9,20)	4,28	7,90	1,87(0,63-2,66)	935	9,00	1,28	1,60	2,69	3,83	9,40(4,20-10,60)	4,70	4,70	2,00(0,81-2,86)	1000	9,40
20+25+50+50	1,10	1,38	2,76	2,76	8,00(3,00-9,20)	4,23	7,90	1,89(0,70-2,60)	945	9,00	1,30	1,62	3,24	3,24	9,40(4,20-10,60)	4,68	4,70	2,01(0,94-2,89)	1005	9,40
20+35+35+35	1,28	2,24	2,24	2,24	8,00(3,00-9,20)	4,17	7,90	1,92(0,57-2,72)	960	9,20	1,51	2,63	2,63	2,63	9,40(4,20-10,60)	4,75	4,70	1,98(0,75-2,90)	990	9,30
20+35+35+42	1,21	2,12	2,12	2,55	8,00(3,00-9,20)	4,17	7,90	1,92(0,57-2,72)	960	9,20	1,42	2,49	2,49	3,00	9,40(4,20-10,60)	4,77	4,70	1,97(0,75-2,89)	985	9,30
20+35+35+50	1,14	2,00	2,00	2,86	8,00(3,00-9,20)	4,28	7,90	1,87(0,63-2,66)	935	9,00	1,34	2,35	2,35	3,36	9,40(4,20-10,60)	4,70	4,70	2,00(0,84-2,85)	1000	9,40
20+35+42+42	1,15	2,01	2,42	2,42	8,00(3,00-9,20)	4,17	7,90	1,92(0,57-2,72)	960	9,20	1,35	2,37	2,84	2,84	9,40(4,20-10,60)	4,77	4,70	1,97(0,76-2,88)	985	9,30
20+35+42+50	1,09	1,90	2,29	2,72	8,00(3,00-9,20)	4,28	7,90	1,87(0,63-2,66)	935	9,00	1,28	2,24	2,69	3,19	9,40(4,20-10,60)	4,72	4,70	1,99(0,85-2,84)	995	9,40
20+42+42+42	1,10	2,30	2,30	2,30	8,00(3,00-9,20)	4,28	7,90	1,87(0,58-2,72)	935	9,00	1,30	2,70	2,70	2,70	9,40(4,20-10,60)	4,70	4,70	2,00(0,76-2,87)	10	

Free Multi 5x1 CU-5Z90TBE. Minimum capacity connected: 4,50 kW. Maximum capacity connected: 18,30 kW • R32 GAS

Indoor unit capacity	Cooling capacity (kW) Rooms					EER	SEER ¹	Input power rating			Heating capacity (kW) Rooms					COP	SCOP ¹	Input power rating								
	A	B	C	D	E			Total (Min - Max)	W/W	W/W	kW	kWh	230V	A	B			C	D	E	Total (Min - Max)	W/W	W/W	kW	kWh	230V
1 Room																										
16	1,60					1,60(1,30-2,30)	4,00	A	0,40	0,25-0,64	200	2,00	2,60						2,60	1,20-3,20	4,33	A	0,60	0,30-0,96	300	3,00
20	2,00					2,00(1,80-2,90)	4,00	A	0,50	0,34-0,81	250	2,50	3,20						3,20	1,20-4,10	4,32	A	0,74	0,30-1,23	370	3,70
25	2,50					2,50(1,80-2,90)	3,97	A	0,63	0,34-0,81	315	3,20	3,60						3,60	1,20-4,30	3,83	A	0,94	0,30-1,23	470	4,70
35	3,50					3,50(1,80-4,10)	3,72	A	0,94	0,34-1,36	470	4,50	4,50						4,50	1,20-5,80	3,66	A	1,23	0,30-2,10	615	6,00
42	4,20					4,20(1,80-4,50)	3,07	B	1,37	0,34-1,99	685	6,40	5,60						5,60	1,20-6,80	3,26	C	1,72	0,30-2,93	860	8,00
50	5,00					5,00(1,90-5,70)	3,23	A	1,55	0,34-2,13	775	7,20	6,80						6,80	1,20-6,90	3,24	C	2,10	0,30-2,52	1050	9,70
60	6,00					6,00(1,90-6,20)	2,96	C	2,03	0,34-2,33	1015	9,20	8,50						8,50	1,30-9,00	3,54	B	2,40	0,62-2,55	1200	11,10
71	7,10					7,10(2,00-7,20)	2,81	C	2,53	0,37-2,77	1265	11,40	8,70						8,70	1,40-9,20	3,41	B	2,55	0,68-2,72	1275	11,80
2 Rooms																										
16+16	1,60	1,60				3,20(2,40-5,80)	4,85	A	5,60	0,66(0,27-1,74)	330	3,40	2,35	2,35					4,70	2,00-8,20	3,88	A	3,80	1,21(0,22-2,41)	605	5,80
16+20	1,60	2,00				3,60(2,40-5,80)	4,56	A	5,60	0,79(0,27-1,74)	395	4,00	2,31	2,89					5,20	2,00-8,20	3,80	A	3,80	1,37(0,22-2,40)	685	6,50
16+25	1,60	2,50				4,10(2,40-5,80)	4,27	A	5,60	0,96(0,27-1,74)	480	4,70	2,19	3,41					5,60	2,00-8,20	3,73	A	3,80	1,50(0,22-2,40)	750	7,10
16+35	1,60	3,50				5,10(2,40-5,80)	3,86	A	5,60	1,32(0,26-1,68)	660	6,40	2,01	4,39					6,40	2,00-8,60	3,79	A	3,80	1,69(0,21-2,48)	845	8,00
16+42	1,60	4,20				5,80(2,40-6,70)	3,56	A	5,60	1,63(0,26-2,13)	815	7,90	2,04	5,36					7,40	2,00-10,10	3,72	A	3,80	1,99(0,21-3,03)	995	9,40
16+50	1,60	5,00				6,60(2,40-7,20)	3,59	A	6,10	1,84(0,25-2,13)	920	8,80	2,06	6,44					8,50	2,00-11,00	3,86	A	4,00	2,20(0,16-3,04)	1100	10,30
16+60	1,60	6,00				7,60(2,40-8,60)	3,21	A	6,10	2,37(0,25-3,08)	1185	11,30	2,11	7,89					10,00	2,00-11,00	3,75	A	4,00	2,67(0,16-3,04)	1335	12,50
16+71	1,60	7,10				8,70(2,50-9,10)	2,98	C	6,10	2,92(0,27-3,16)	1460	14,00	1,88	8,32					10,20	2,00-13,00	3,82	A	4,00	2,67(0,16-3,83)	1335	12,50
20+20	2,00	2,00				4,00(2,40-5,80)	4,35	A	5,60	0,92(0,26-1,68)	460	4,50	2,90	2,90					5,80	2,00-8,20	3,79	A	3,80	1,53(0,22-2,39)	765	7,30
20+25	2,00	2,50				4,50(2,40-5,80)	4,02	A	5,60	1,12(0,26-1,68)	560	5,50	2,71	3,39					6,10	2,00-8,20	3,77	A	3,80	1,62(0,22-2,39)	810	7,70
20+35	2,00	3,50				5,50(2,40-5,80)	3,74	A	5,60	1,47(0,26-1,63)	735	7,10	2,51	4,39					6,90	2,00-8,60	3,81	A	3,80	1,81(0,21-2,42)	905	8,50
20+42	2,00	4,20				6,20(2,40-7,20)	3,37	A	5,60	1,84(0,26-2,49)	920	8,80	2,55	5,35					7,90	2,00-11,00	3,66	A	3,80	2,16(0,20-3,23)	1080	10,20
20+50	2,00	5,00				7,00(2,40-8,10)	3,59	A	6,10	1,95(0,25-2,61)	975	9,30	2,57	6,43					9,00	2,00-11,00	3,98	A	4,00	2,26(0,16-2,98)	1130	10,60
20+60	2,00	6,00				8,00(2,40-8,60)	3,14	B	6,10	2,55(0,25-3,01)	1275	12,20	2,60	7,80					10,40	2,00-11,90	3,88	A	4,00	2,68(0,16-3,33)	1340	12,60
20+71	1,98	7,02				9,00(2,50-10,00)	2,88	C	6,10	3,12(0,27-4,03)	1560	14,90	2,29	8,11					10,40	2,00-13,00	3,97	A	4,00	2,62(0,16-3,82)	1310	12,30
25+25	2,50	2,50				5,00(2,40-5,80)	3,94	A	5,60	1,27(0,26-1,68)	635	6,10	3,25	3,25					6,50	2,00-8,60	3,82	A	3,80	1,70(0,22-2,50)	850	8,10
25+35	2,50	3,50				6,00(2,40-6,70)	3,47	A	5,60	1,73(0,26-2,13)	865	8,40	3,04	4,26					7,30	2,00-10,10	3,76	A	3,80	1,94(0,21-3,03)	970	9,10
25+42	2,50	4,20				6,70(2,40-7,20)	3,15	B	5,60	2,13(0,26-2,49)	1065	10,20	3,10	5,20					8,30	2,00-11,00	3,61	A	3,80	2,30(0,20-3,23)	1150	10,80
25+50	2,50	5,00				7,50(2,40-8,60)	3,33	A	6,10	2,25(0,25-3,01)	1125	10,80	3,13	6,27					9,40	2,00-11,00	3,84	A	4,00	2,45(0,16-2,98)	1225	11,50
25+60	2,50	6,00				8,50(2,50-9,10)	2,89	C	6,10	2,94(0,27-3,29)	1470	14,10	3,06	7,34					10,40	2,00-13,00	3,88	A	4,00	2,68(0,16-3,83)	1340	12,60
25+71	2,34	6,66				9,00(2,50-10,10)	2,88	C	6,10	3,12(0,27-4,18)	1560	14,90	2,71	7,69					10,40	2,00-13,00	3,97	A	4,00	2,62(0,16-3,82)	1310	12,30
35+35	3,50	3,50				7,00(2,40-8,10)	3,11	B	5,60	2,25(0,26-3,06)	1125	10,80	4,05	4,05					8,10	2,00-11,00	3,70	A	3,80	2,19(0,20-3,22)	1095	10,30
35+42	3,50	4,20				7,70(2,40-8,60)	2,88	C	5,60	2,67(0,26-3,55)	1335	12,80	4,14	4,96					9,10	2,00-11,00	3,65	A	3,80	2,49(0,20-3,16)	1245	11,70
35+50	3,50	5,00				8,50(2,50-9,10)	3,02	B	6,10	2,81(0,27-3,16)	1405	13,50	4,20	6,00					10,20	2,00-13,00	3,94	A	4,00	2,59(0,16-3,81)	1295	12,20
35+60	3,32	5,68				9,00(2,50-10,10)	2,82	C	6,10	3,19(0,27-4,18)	1595	15,30	3,83	6,57					10,40	2,00-13,00	3,98	A	4,00	2,61(0,16-3,81)	1305	12,30
35+71	2,97	6,03				9,00(2,50-10,40)	3,01	B	6,10	2,99(0,27-4,34)	1495	14,30	3,43	6,97					10,40	2,00-13,80	4,02	A	4,00	2,59(0,16-4,14)	1295	12,20
42+42	4,20	4,20				8,40(2,50-9,10)	2,51	E	5,60	3,34(0,28-3,96)	1670	16,00	5,05	5,05					10,10	2,00-13,00	3,62	A	3,80	2,79(0,19-3,99)	1395	13,10
42+50	4,11	4,89				9,00(2,50-10,00)	2,88	C	6,10	3,12(0,27-4,03)	1560	14,90	4,75	5,65					10,40	2,00-13,00	4,00	A	4,00	2,60(0,16-3,74)	1300	12,20
42+60	3,71	5,29				9,00(2,50-10,40)	2,88	C	6,10	3,12(0,27-4,33)	1560	14,90	4,28	6,12					10,40	2,00-13,80	4,00	A	4,00	2,60(0,16-4,15)	1300	12,20
42+71	3,35	5,65				9,00(2,50-10,40)	3,01	B	6,10	2,99(0,27-4,34)	1495	14,30	3,87	6,53					10,40	2,00-13,80	4,03	A	4,00	2,58(0,16-4,13)	1290	12,10
50+50	4,50	4,50				9,00(2,50-10,40)	3,38	A	6,10	2,66(0,26-3,61)	1330	12,70	5,20	5,20					10,40	2,00-13,80	4,28	A	4,00	2,43(0,17-3,90)	1215	11,40
50+60	4,09	4,91				9,00(2,50-10,40)	3,38	A	6,10	2,66(0,26-3,61)	1330	12,70	4,73	5,67					10,40	2,00-13,80	4,28	A	4,00	2,43(0,17-3,90)	1215	11,40
50+71	3,72	5,28				9,00(2,50-10,40)	3,46	A	6,10	2,60(0,26-3,48)	1300	12,40	4,30	6,10					10,40	2,00-13,80	4,32	A	4,00	2,41(0,17-3,89)	1205	11,30
60+60	4,50	4,50				9,00(2,50-10,40)	3,38	A	6,10	2,66(0,26-3,61)	1330	12,70	5,20	5,20					10,40	2,00-13,80	4,28	A	4,00	2,43(0,17-3,90)	1215	11,40
60+71	4,12	4,88				9,00(2,50-10,40)	3,46	A	6,10	2,60(0,26-3,48)	1300	12,40	4,76	5,64					10,40	2,00-13,80	4,32	A	4,00	2,41(0,17-3,89)	1205	11,30
71+71	4,50	4,50				9,00(2,50-10,40)	3,64	A	6,10	2,47(0,29-3,34)	1235	11,80	5,20	5,20					10,40	2,00-13,80	4,43	A	4,00	2,35(0,18-3,87)	1175	11,00
3 Rooms																										

FREE MULTI R32 COMBINATIONS TABLE

Free Multi 5x1 CU-5Z90TBE. Minimum capacity connected: 4,50 kW. Maximum capacity connected: 18,30 kW • R32 GAS

Indoor unit capacity	Cooling capacity(kW) Rooms								EER	SEER ¹	Input power A.E.C. Current			Heating capacity(kW) Rooms								COP	SCOP ¹	Input power A.E.C. Current		
	A	B	C	D	E	Total (Min -Max)	W/W	W/W			kW	kWh	230V	A	B	C	D	E	Total (Min -Max)	W/W	W/W			kW	kWh	230V
16+60+60	1,06	3,97	3,97			9,00(3,00-10,70)	4,17	7,20	2,16(0,40-2,94)	1080	10,30	1,22	4,59	4,59			10,40(2,70-14,10)	4,79	4,20	2,17(0,30-3,67)	1085	10,20				
16+60+71	0,98	3,67	4,35			9,00(3,00-10,70)	4,15	7,20	2,17(0,40-2,87)	1085	10,40	1,13	4,24	5,03			10,40(2,70-14,10)	4,81	4,20	2,16(0,31-3,65)	1080	10,20				
16+71+71	0,92	4,04	4,04			9,00(3,00-10,70)	4,27	7,20	2,11(0,40-2,81)	1055	10,10	1,06	4,67	4,67			10,40(2,70-14,40)	4,75	4,20	2,19(0,32-3,75)	1095	10,30				
20+20+20	2,00	2,00	2,00			6,00(2,90-8,50)	4,32	7,20	1,39(0,31-2,55)	695	6,70	2,86	2,86	2,86			10,40(2,70-12,30)	4,33	4,10	1,98(0,23-3,35)	990	9,30				
20+20+25	2,00	2,00	2,50			6,50(2,90-8,50)	4,06	7,20	1,60(0,31-2,55)	800	7,70	2,77	2,77	3,46			9,00(2,70-12,30)	4,25	4,10	2,12(0,23-3,35)	1060	10,00				
20+20+35	2,00	2,00	3,50			7,50(2,90-8,50)	3,85	7,20	1,95(0,34-2,49)	975	9,30	2,61	2,61	4,58			9,80(2,70-12,30)	4,12	4,10	2,38(0,23-3,26)	1190	11,20				
20+20+42	2,00	2,00	4,20			8,20(2,90-8,70)	3,57	7,20	2,30(0,34-2,54)	1150	11,00	2,54	2,54	5,32			10,40(2,70-12,90)	4,24	4,10	2,45(0,23-3,53)	1225	11,50				
20+20+50	2,00	2,00	5,00			9,00(2,90-9,60)	3,73	7,20	2,41(0,34-2,62)	1205	11,50	2,31	2,31	5,78			10,40(2,70-13,60)	4,54	4,20	2,29(0,25-3,62)	1145	10,80				
20+20+60	1,80	1,80	5,40			9,00(2,90-10,70)	3,73	7,20	2,41(0,34-3,41)	1205	11,50	2,08	2,08	6,24			10,40(2,70-13,60)	4,54	4,20	2,29(0,25-3,62)	1145	10,80				
20+20+71	1,62	1,62	5,76			9,00(2,90-10,70)	3,83	7,20	2,35(0,34-3,27)	1175	11,20	1,87	1,87	6,66			10,40(2,70-13,80)	4,56	4,20	2,28(0,25-3,71)	1140	10,70				
20+25+25	2,00	2,50	2,50			7,00(2,90-8,50)	3,93	7,20	1,78(0,31-2,55)	890	8,50	2,68	3,36	3,36			9,40(2,70-12,30)	4,16	4,10	2,26(0,23-3,35)	1130	10,60				
20+25+35	2,00	2,50	3,50			8,00(2,90-8,50)	3,67	7,20	2,18(0,34-2,49)	1090	10,40	2,55	3,19	4,46			10,20(2,70-12,90)	4,16	4,10	2,45(0,23-3,54)	1225	11,50				
20+25+42	2,00	2,50	4,20			8,70(2,90-9,60)	3,43	7,20	2,54(0,34-3,00)	1270	12,20	2,39	2,99	5,02			10,40(2,70-13,60)	4,24	4,20	2,45(0,23-3,87)	1225	11,50				
20+25+50	1,89	2,37	4,74			9,00(2,90-10,10)	3,73	7,20	2,41(0,34-2,94)	1205	11,50	2,19	2,74	5,47			10,40(2,70-13,60)	4,54	4,20	2,29(0,25-3,62)	1145	10,80				
20+25+60	1,71	2,14	5,15			9,00(2,90-10,70)	3,73	7,20	2,41(0,34-3,41)	1205	11,50	1,98	2,48	5,94			10,40(2,70-13,80)	4,54	4,20	2,29(0,25-3,73)	1145	10,80				
20+25+71	1,55	1,94	5,51			9,00(2,90-10,70)	3,83	7,20	2,35(0,34-3,27)	1175	11,20	1,79	2,24	6,37			10,40(2,70-13,80)	4,56	4,20	2,28(0,25-3,71)	1140	10,70				
20+35+35	2,00	3,50	3,50			9,00(2,90-9,60)	3,38	7,20	2,66(0,34-2,93)	1330	12,70	2,32	4,04	4,04			10,40(2,70-13,60)	4,28	4,20	2,43(0,24-3,85)	1215	11,40				
20+35+42	1,85	3,25	3,90			9,00(2,90-10,70)	3,38	7,20	2,66(0,34-3,91)	1330	12,70	2,14	3,75	4,51			10,40(2,70-13,60)	4,30	4,20	2,42(0,24-3,78)	1210	11,40				
20+35+50	1,71	3,00	4,29			9,00(2,90-10,70)	3,83	7,20	2,35(0,34-3,34)	1175	11,20	1,98	3,47	4,95			10,40(2,70-13,80)	4,60	4,20	2,26(0,27-3,70)	1130	10,60				
20+35+60	1,56	2,74	4,70			9,00(2,90-10,70)	3,83	7,20	2,35(0,34-3,34)	1175	11,20	1,81	3,17	5,42			10,40(2,70-13,80)	4,60	4,20	2,26(0,27-3,70)	1130	10,60				
20+35+71	1,43	2,50	5,07			9,00(2,90-10,70)	3,95	7,20	2,28(0,37-3,20)	1140	10,90	1,65	2,89	5,86			10,40(2,70-13,80)	4,62	4,20	2,25(0,27-3,68)	1125	10,60				
20+42+42	1,74	3,63	3,63			9,00(2,90-10,70)	3,46	7,20	2,60(0,34-3,91)	1300	12,40	2,00	4,20	4,20			10,40(2,70-13,60)	4,32	4,20	2,41(0,24-3,77)	1205	11,30				
20+42+50	1,60	3,38	4,02			9,00(2,90-10,70)	3,83	7,20	2,35(0,34-3,27)	1175	11,20	1,86	3,90	4,64			10,40(2,70-13,80)	4,60	4,20	2,26(0,27-3,68)	1130	10,60				
20+42+60	1,47	3,10	4,43			9,00(2,90-10,70)	3,83	7,20	2,35(0,34-3,27)	1175	11,20	1,70	3,58	5,12			10,40(2,70-13,80)	4,60	4,20	2,26(0,27-3,68)	1130	10,60				
20+42+71	1,35	2,84	4,81			9,00(2,90-10,70)	3,95	7,20	2,28(0,37-3,20)	1140	10,90	1,56	3,28	5,56			10,40(2,70-14,10)	4,64	4,20	2,24(0,27-3,78)	1120	10,50				
20+50+50	1,50	3,75	3,75			9,00(2,90-10,70)	4,17	7,20	2,16(0,37-2,94)	1080	10,30	1,74	4,33	4,33			10,40(2,70-13,80)	4,81	4,20	2,16(0,31-3,48)	1080	10,20				
20+50+60	1,38	3,46	4,16			9,00(2,90-10,70)	4,17	7,20	2,16(0,37-2,94)	1080	10,30	1,60	4,00	4,80			10,40(2,70-14,10)	4,81	4,20	2,16(0,31-3,65)	1080	10,20				
20+50+71	1,28	3,19	4,53			9,00(3,00-10,70)	4,15	7,20	2,17(0,40-2,87)	1085	10,40	1,48	3,69	5,23			10,40(2,70-14,10)	4,75	4,20	2,19(0,32-3,64)	1095	10,30				
20+60+60	1,28	3,86	3,86			9,00(3,00-10,70)	4,17	7,20	2,16(0,40-2,94)	1080	10,30	1,48	4,46	4,46			10,40(2,70-14,10)	4,81	4,20	2,16(0,31-3,65)	1080	10,20				
20+60+71	1,19	3,58	4,23			9,00(3,00-10,70)	4,15	7,20	2,17(0,40-2,87)	1085	10,40	1,38	4,13	4,89			10,40(2,70-14,40)	4,75	4,20	2,19(0,32-3,75)	1095	10,30				
20+71+71	1,12	3,94	3,94			9,00(3,00-10,70)	4,27	7,20	2,11(0,41-2,81)	1055	10,10	1,28	4,56	4,56			10,40(2,70-14,40)	4,77	4,20	2,18(0,33-3,74)	1090	10,20				
25+25+25	2,50	2,50	2,50			7,50(2,90-8,50)	3,73	7,20	2,01(0,31-2,55)	1005	9,60	3,23	3,23	3,23			9,69(2,70-12,30)	4,02	4,10	2,41(0,23-3,35)	1205	11,30				
25+25+35	2,50	2,50	3,50			8,50(2,90-9,60)	3,41	7,20	2,49(0,34-3,00)	1245	11,90	3,06	3,06	4,28			10,40(2,70-13,60)	4,23	4,20	2,46(0,23-3,89)	1230	11,60				
25+25+42	2,45	2,45	4,10			9,00(2,90-10,10)	3,30	7,20	2,73(0,34-3,40)	1365	13,10	2,83	2,83	4,74			10,40(2,70-13,60)	4,24	4,20	2,45(0,23-3,87)	1225	11,50				
25+25+50	2,25	2,25	4,50			9,00(2,90-10,70)	3,73	7,20	2,41(0,34-3,41)	1205	11,50	2,60	2,60	5,20			10,40(2,70-13,60)	4,54	4,20	2,29(0,25-3,62)	1145	10,80				
25+25+60	2,05	2,05	4,90			9,00(2,90-10,70)	3,73	7,20	2,41(0,34-3,41)	1205	11,50	2,36	2,36	5,68			10,40(2,70-13,80)	4,54	4,20	2,29(0,25-3,73)	1145	10,80				
25+25+71	1,86	1,86	5,28			9,00(2,90-10,70)	3,83	7,20	2,35(0,34-3,27)	1175	11,20	2,15	2,15	6,10			10,40(2,70-13,80)	4,56	4,20	2,28(0,25-3,71)	1140	10,70				
25+35+35	2,36	3,32	3,32			9,00(2,90-10,10)	3,38	7,20	2,66(0,34-3,33)	1330	12,70	2,74	3,83	3,83			10,40(2,70-13,60)	4,28	4,20	2,43(0,24-3,85)	1215	11,40				
25+35+42	2,20	3,09	3,71			9,00(2,90-10,70)	3,38	7,20	2,66(0,34-3,91)	1330	12,70	2,55	3,57	4,28			10,40(2,70-13,60)	4,30	4,20	2,42(0,24-3,78)	1210	11,40				
25+35+50	2,05	2,86	4,09			9,00(2,90-10,70)	3,83	7,20	2,35(0,34-3,34)	1175	11,20	2,36	3,31	4,73			10,40(2,70-13,80)	4,60	4,20	2,26(0,27-3,70)	1130	10,60				
25+35+60	1,87	2,63	4,50			9,00(2,90-10,70)	3,83	7,20	2,35(0,34-3,34)	1175	11,20	2,17	3,03	5,20			10,40(2,70-13,80)	4,60	4,20	2,26(0,27-3,70)	1130	10,60				
25+35+71	1,72	2,40	4,88			9,00(2,90-10,70)	3,95	7,20	2,28(0,37-3,20)	1140	10,90	1,98	2,78	5,64			10,40(2,70-14,10)	4,62	4,20	2,25(0,27-3,80)	1125	10,60				
25+42+42	2,06	3,47	3,47			9,00(2,90-10,70)	3,46	7,20	2,60(0,34-3,91)	1300	12,40	2,38	4,01	4,01			10,40(2,70-13,80)	4,32	4,20	2,41(0,24-3,89)	1205	11,30				
25+42+50	1,92	3,23	3,85			9,00(2,90-10,70)	3,83	7,20	2,35(0,34-3,27)	1175	11,20	2,22	3,73	4,45			10,40(2,70-13,80)	4,60	4,20	2,26(0,27-3,68)	1130	10,60				
25+42+60	1,77	2,98	4,25			9,00(2,90-10,70)	3,83	7,20	2,35(0,34-3,27)	1175	11,20	2,05	3,44	4,91			10,40(2,70-14,10)	4,60	4,20	2,26(0,27-3,80)	1130	10,60				
25+42+71	1,63	2,74	4,63			9,00(3,00-10,70)	3,95	7,20	2,28(0,37-3,20)	1140	10,90	1,88	3,17	5,35			10,40(2,70-14,10)	4,64	4,20	2,24(0,27-3,78)	1120	10,50				
25+50+50	1,80	3,60	3,60			9,00(2,90-10,70)	4,17	7,20	2,16(0,37-2,94)	1080	10,30	2,08	4,16	4,16			10,40(2,70-13,80)	4,81	4,20	2,16(0,31-3,48)	1080	10,20				
25+50+60	1,67	3,33	4,40			9,00(3,00-10,70)	4,17	7,20	2,16(0,40-2,94)	1080	10,30	1,93	3,85	4,62			10,40(2,70-14,10)	4,81	4,20	2,16(0,31-3,65)	1080	10,20				
25+50+71	1,54	3,08	4,38			9,00(3,00-10,70)	4,15	7,20	2,17(0,40-2,87)	1085	10,40	1,78	3,56	5,06			10,40(2,70-14,10)	4,75	4,20	2,19(0,32-3,64)	1095	10,30				

Free Multi 5x1 CU-5Z90TBE. Minimum capacity connected: 4,50 kW. Maximum capacity connected: 18,30 kW • R32 GAS

Table with columns: Indoor unit capacity, Cooling capacity (kW) Rooms, EER, SEER', Input power rating, A.E.C. Current, Heating capacity (kW) Rooms, COP, SCOP', Input power rating, A.E.C. Current. Rows include configurations like 50+60+71, 60+60+60, and various 4 Rooms setups.

Rating Conditions: Cooling Indoor 27 °C DB / 19 °C WB. Cooling Outdoor 35 °C DB / 24 °C WB. Heating Indoor 20 °C DB. Heating Outdoor 7 °C DB / 4 °C WB. (DB: Dry Bulb; WB: Wet Bulb) Specifications subject to change without notice. For detailed information about ErP / Energy Labelling, please visit our websites www.aircon.panasonic.eu or www.ptc.panasonic.eu.

FREE MULTI R32 COMBINATIONS TABLE

Free Multi 5x1 CU-5Z90TBE. Minimum capacity connected: 4,50 kW. Maximum capacity connected: 18,30 kW • R32 GAS

Indoor unit capacity	Cooling capacity(kW) Rooms					EER	SEER ¹	Input power A.E.C. Current			Heating capacity(kW) Rooms					COP	SCOP ¹	Input power A.E.C. Current				
	A	B	C	D	E			Total (Min - Max)	W/W	W/W	kW	kWh	230V	A	B			C	D	E	Total (Min - Max)	W/W
16+25+42+60	1,01	1,57	2,64	3,78		9,00(3,00-11,00)	3,98	8,00	2,26(0,44-3,26)	1130	10,80	1,16	1,82	3,05	4,37		10,40(3,40-14,40)	4,91	4,40	2,12(0,42-3,63)	1060	10,00
16+25+42+71	0,94	1,46	2,45	4,15		9,00(3,00-11,00)	4,09	8,00	2,20(0,44-3,19)	1100	10,50	1,08	1,69	2,84	4,79		10,40(3,40-14,40)	4,81	4,40	2,16(0,43-3,61)	1080	10,20
16+25+50+50	1,02	1,60	3,19	3,19		9,00(2,90-10,80)	4,07	8,00	2,21(0,49-2,98)	1105	10,60	1,18	1,84	3,69	3,69		10,40(3,40-14,40)	4,84	4,40	2,15(0,50-3,56)	1075	10,10
16+25+50+60	0,95	1,49	2,98	3,58		9,00(3,00-11,00)	4,07	8,00	2,21(0,49-3,12)	1105	10,60	1,10	1,72	3,44	4,14		10,40(3,40-14,40)	4,84	4,40	2,15(0,50-3,56)	1075	10,10
16+25+50+71	0,89	1,39	2,78	3,94		9,00(3,00-11,20)	4,07	8,00	2,21(0,52-3,20)	1105	10,60	1,03	1,60	3,21	4,56		10,40(3,40-14,40)	4,84	4,40	2,15(0,51-3,60)	1075	10,10
16+25+60+60	0,89	1,41	3,35	3,35		9,00(3,00-11,20)	4,07	8,00	2,21(0,49-3,19)	1105	10,60	1,03	1,61	3,88	3,88		10,40(3,40-14,40)	4,84	4,40	2,15(0,50-3,56)	1075	10,10
16+25+60+71	0,83	1,31	3,14	3,72		9,00(3,00-11,20)	4,07	8,00	2,21(0,52-3,20)	1105	10,60	0,97	1,51	3,63	4,29		10,40(3,40-14,40)	4,84	4,40	2,15(0,51-3,60)	1075	10,10
16+25+71+71	0,79	1,23	3,49	3,49		9,00(3,00-11,20)	4,17	8,00	2,16(0,53-3,20)	1080	10,30	0,91	1,43	4,03	4,03		10,40(3,40-14,40)	4,81	4,40	2,18(0,52-3,59)	1090	10,20
16+35+35+35	1,20	2,60	2,60	2,60		9,00(2,90-10,80)	3,90	8,00	2,31(0,38-3,33)	1155	11,10	1,37	3,01	3,01	3,01		10,40(3,40-14,20)	4,84	4,40	2,15(0,37-3,64)	1075	10,10
16+35+35+42	1,13	2,46	2,46	2,95		9,00(2,90-10,80)	3,90	8,00	2,31(0,40-3,33)	1155	11,10	1,30	2,84	2,84	3,42		10,40(3,40-14,40)	4,75	4,40	2,19(0,37-3,75)	1095	10,30
16+35+35+50	1,05	2,32	2,32	3,31		9,00(2,90-10,80)	4,09	8,00	2,20(0,44-3,11)	1100	10,50	1,22	2,68	2,68	3,82		10,40(3,40-14,40)	4,81	4,40	2,16(0,43-3,61)	1080	10,20
16+35+35+60	0,98	2,16	2,16	3,70		9,00(3,00-11,00)	4,09	8,00	2,20(0,44-3,26)	1100	10,50	1,14	2,49	2,49	4,28		10,40(3,40-14,40)	4,81	4,40	2,16(0,43-3,61)	1080	10,20
16+35+35+71	0,91	2,01	2,01	4,07		9,00(3,00-11,00)	4,09	8,00	2,20(0,47-3,19)	1100	10,50	1,06	2,32	2,32	4,70		10,40(3,40-14,40)	4,84	4,40	2,15(0,45-3,65)	1075	10,10
16+35+42+42	1,07	2,33	2,80	2,80		9,00(3,00-10,80)	3,90	8,00	2,31(0,40-3,33)	1155	11,10	1,22	2,70	3,24	3,24		10,40(3,40-14,40)	4,77	4,40	2,18(0,37-3,73)	1090	10,20
16+35+42+50	1,01	2,20	2,64	3,15		9,00(3,00-11,00)	4,09	8,00	2,20(0,44-3,26)	1100	10,50	1,16	2,55	3,05	3,64		10,40(3,40-14,40)	4,84	4,40	2,15(0,45-3,65)	1075	10,10
16+35+42+60	0,94	2,06	2,47	3,53		9,00(3,00-11,00)	4,09	8,00	2,20(0,44-3,26)	1100	10,50	1,09	2,38	2,85	4,08		10,40(3,40-14,40)	4,84	4,40	2,15(0,45-3,65)	1075	10,10
16+35+42+71	0,88	1,92	3,30	3,90		9,00(3,00-11,20)	4,09	8,00	2,20(0,47-3,33)	1100	10,50	1,01	2,22	2,66	4,51		10,40(3,40-14,40)	4,86	4,40	2,14(0,45-3,64)	1070	10,10
16+35+50+50	0,95	2,09	2,98	2,98		9,00(3,00-11,00)	4,07	8,00	2,21(0,52-3,05)	1105	10,60	1,10	2,42	3,44	3,44		10,40(3,40-14,40)	4,77	4,40	2,18(0,52-3,59)	1090	10,20
16+35+50+60	0,89	1,96	2,80	3,35		9,00(3,00-11,20)	4,07	8,00	2,21(0,52-3,20)	1105	10,60	1,03	2,26	3,23	3,88		10,40(3,40-14,40)	4,77	4,40	2,18(0,52-3,59)	1090	10,20
16+35+50+71	0,83	1,83	2,62	3,72		9,00(3,00-11,20)	4,19	8,00	2,15(0,52-3,20)	1075	10,30	0,97	2,12	3,02	4,29		10,40(3,40-14,40)	4,77	4,40	2,18(0,54-3,57)	1090	10,20
16+35+60+60	0,84	1,84	3,16	3,16		9,00(3,00-11,20)	4,07	8,00	2,21(0,52-3,20)	1105	10,60	0,97	2,13	3,65	3,65		10,40(3,40-14,40)	4,77	4,40	2,18(0,52-3,59)	1090	10,20
16+35+60+71	0,79	1,73	2,97	3,51		9,00(3,00-11,20)	4,19	8,00	2,15(0,52-3,20)	1075	10,30	0,91	2,00	3,43	4,06		10,40(3,40-14,40)	4,77	4,40	2,14(0,54-3,57)	1090	10,20
16+42+42+42	1,02	2,66	2,66	2,66		9,00(3,00-11,00)	3,90	8,00	2,31(0,40-3,48)	1155	11,10	1,16	3,08	3,08	3,08		10,40(3,40-14,40)	4,79	4,40	2,17(0,39-3,72)	1085	10,20
16+42+42+50	0,96	2,52	2,52	3,00		9,00(3,00-11,00)	4,09	8,00	2,20(0,44-3,19)	1100	10,50	1,11	2,91	2,91	3,47		10,40(3,40-14,40)	4,84	4,40	2,15(0,45-3,64)	1075	10,10
16+42+42+60	0,90	2,36	2,36	3,38		9,00(3,00-11,20)	4,09	8,00	2,20(0,44-3,33)	1100	10,50	1,04	2,73	2,73	3,90		10,40(3,40-14,40)	4,84	4,40	2,15(0,45-3,64)	1075	10,10
16+42+42+71	0,84	2,21	2,21	3,74		9,00(3,00-11,20)	4,09	8,00	2,20(0,48-3,34)	1100	10,50	0,97	2,55	3,55	4,33		10,40(3,40-14,40)	4,86	4,40	2,14(0,46-3,63)	1070	10,10
16+42+50+50	0,91	2,39	2,85	2,85		9,00(3,00-11,20)	4,07	8,00	2,21(0,52-3,20)	1105	10,60	1,05	2,77	3,29	3,29		10,40(3,40-14,40)	4,77	4,40	2,18(0,53-3,58)	1090	10,20
16+42+50+60	0,86	2,25	2,68	3,21		9,00(3,00-11,20)	4,07	8,00	2,21(0,52-3,20)	1105	10,60	0,99	2,60	3,10	3,71		10,40(3,40-14,40)	4,77	4,40	2,18(0,53-3,58)	1090	10,20
16+42+50+71	0,80	2,11	2,51	3,58		9,00(3,00-11,20)	4,17	8,00	2,16(0,53-3,20)	1080	10,30	0,93	2,44	2,91	4,12		10,40(3,40-14,40)	4,79	4,40	2,17(0,54-3,56)	1085	10,20
16+42+60+60	0,81	2,13	3,03	3,03		9,00(3,00-11,20)	4,07	8,00	2,21(0,52-3,20)	1105	10,60	0,93	2,45	3,51	3,51		10,40(3,40-14,40)	4,77	4,40	2,18(0,53-3,58)	1090	10,20
16+50+50+50	0,87	2,71	2,71	2,71		9,00(3,00-11,20)	4,15	8,00	2,17(0,57-3,14)	1085	10,40	1,01	3,13	3,13	3,13		10,40(3,40-14,40)	4,66	4,40	2,23(0,63-3,58)	1115	10,50
16+50+50+60	0,81	2,56	2,56	3,07		9,00(3,00-11,20)	4,15	8,00	2,17(0,57-3,14)	1085	10,40	0,95	2,95	2,95	3,55		10,40(3,40-14,40)	4,66	4,40	2,23(0,63-3,58)	1115	10,50
20+20+20+20	2,00	2,00	2,00	2,00		8,00(2,90-10,60)	4,06	8,00	1,97(0,37-3,40)	985	9,40	2,60	2,60	2,60	2,60		10,40(3,40-14,20)	4,71	4,20	2,21(0,34-3,79)	1105	10,40
20+20+20+25	2,00	2,00	2,00	2,50		8,50(2,90-10,60)	3,95	8,00	2,15(0,37-3,40)	1075	10,30	2,45	2,45	2,45	3,05		10,40(3,40-14,20)	4,71	4,20	2,21(0,34-3,79)	1105	10,40
20+20+20+35	1,89	1,89	1,89	3,33		9,00(2,90-10,60)	3,78	8,00	2,38(0,37-3,33)	1190	11,40	2,19	2,19	2,19	3,83		10,40(3,40-14,20)	4,75	4,40	2,19(0,35-3,76)	1095	10,30
20+20+20+42	1,76	1,76	1,76	3,72		9,00(2,90-10,60)	3,78	8,00	2,38(0,37-3,33)	1190	11,40	2,04	2,04	2,04	4,28		10,40(3,40-14,20)	4,77	4,40	2,18(0,36-3,74)	1090	10,20
20+20+20+50	1,64	1,64	1,64	4,08		9,00(2,90-10,60)	4,00	8,00	2,25(0,41-3,04)	1125	10,80	1,89	1,89	1,89	4,73		10,40(3,40-14,20)	4,86	4,40	2,14(0,42-3,60)	1070	10,10
20+20+20+60	1,50	1,50	1,50	4,50		9,00(2,90-10,60)	4,00	8,00	2,25(0,41-3,04)	1125	10,80	1,73	1,73	1,73	5,21		10,40(3,40-14,20)	4,86	4,40	2,14(0,42-3,60)	1070	10,10
20+20+20+71	1,37	1,37	1,37	4,89		9,00(2,90-10,60)	4,09	8,00	2,20(0,44-3,11)	1100	10,50	1,59	1,59	1,59	5,63		10,40(3,40-14,40)	4,88	4,40	2,13(0,42-3,64)	1065	10,00
20+20+25+25	2,00	2,00	2,50	2,50		9,00(2,90-10,60)	3,78	8,00	2,38(0,37-3,40)	1190	11,40	2,31	2,31	2,89	2,89		10,40(3,40-14,20)	4,71	4,40	2,21(0,34-3,79)	1105	10,40
20+20+25+35	1,80	1,80	2,25	3,15		9,00(2,90-10,60)	3,78	8,00	2,38(0,37-3,33)	1190	11,40	2,08	2,08	2,60	3,64		10,40(3,40-14,20)	4,75	4,40	2,19(0,35-3,76)	1095	10,30
20+20+25+42	1,68	1,68	2,10	3,54		9,00(2,90-10,60)	3,78	8,00	2,38(0,37-3,33)	1190	11,40	1,94	1,94	2,43	4,09		10,40(3,40-14,20)	4,77	4,40	2,18(0,36-3,74)	1090	10,20
20+20+25+50	1,57	1,57	1,95	3,91		9,00																

Free Multi 5x1 CU-5Z90TBE. Minimum capacity connected: 4,50 kW. Maximum capacity connected: 18,30 kW • R32 GAS

Indoor unit capacity	Cooling capacity (kW) Rooms										EER	SEER ¹	Input power rating			A.E.C.	Current	Heating capacity (kW) Rooms										COP	SCOP ¹	Input power rating			A.E.C.	Current
	A	B	C	D	E	Total (Min - Max)	W/W	W/W	W/W	kWh			kWh	230V	A			B	C	D	E	Total (Min - Max)	W/W	W/W	W/W	kWh	kWh			230V				
																							kWh	kWh	230V									
20+35+35+35	1,44	2,52	2,52	2,52	9,00	(2,90-10,80)	3,90	A	8,00	▶▶▶	2,31	(0,40-3,33)	1155	11,10	1,67	2,91	2,91	2,91	10,40	(3,40-14,20)	4,75	A	4,40	▶▶	2,19	(0,37-3,63)	1095	10,20						
20+35+35+42	1,36	2,39	2,39	2,86	9,00	(2,90-10,80)	3,90	A	8,00	▶▶▶	2,31	(0,40-3,33)	1155	11,10	1,58	2,76	2,76	3,30	10,40	(3,40-14,40)	4,77	A	4,40	▶▶	2,18	(0,37-3,73)	1090	10,20						
20+35+35+50	1,29	2,25	2,25	3,21	9,00	(2,90-10,80)	4,09	A	8,00	▶▶▶	2,20	(0,44-3,11)	1100	10,50	1,49	2,60	2,60	3,71	10,40	(3,40-14,40)	4,84	A	4,40	▶▶	2,15	(0,45-3,65)	1075	10,10						
20+35+35+60	1,20	2,10	2,10	3,60	9,00	(3,00-11,00)	4,09	A	8,00	▶▶▶	2,20	(0,44-3,26)	1100	10,50	1,39	2,43	2,43	4,15	10,40	(3,40-14,40)	4,84	A	4,40	▶▶	2,15	(0,45-3,65)	1075	10,10						
20+35+35+71	1,11	1,96	1,96	3,97	9,00	(3,00-11,20)	4,09	A	8,00	▶▶▶	2,20	(0,47-3,33)	1100	10,50	1,29	2,26	2,26	4,59	10,40	(3,40-14,40)	4,86	A	4,40	▶▶	2,14	(0,45-3,64)	1070	10,10						
20+35+42+42	1,29	2,27	2,27	2,72	9,00	(2,90-10,80)	3,90	A	8,00	▶▶▶	2,31	(0,40-3,33)	1155	11,10	1,50	2,62	3,14	3,14	10,40	(3,40-14,40)	4,79	A	4,40	▶▶	2,17	(0,39-3,72)	1085	10,20						
20+35+42+50	1,22	2,14	2,57	3,07	9,00	(3,00-11,00)	4,09	A	8,00	▶▶▶	2,20	(0,44-3,19)	1100	10,50	1,41	2,48	2,97	3,54	10,40	(3,40-14,40)	4,84	A	4,40	▶▶	2,15	(0,45-3,64)	1075	10,10						
20+42+42+60	1,14	2,01	2,41	3,44	9,00	(3,00-11,00)	4,09	A	8,00	▶▶▶	2,20	(0,44-3,19)	1100	10,50	1,32	2,32	2,78	3,98	10,40	(3,40-14,40)	4,84	A	4,40	▶▶	2,15	(0,45-3,64)	1075	10,10						
20+35+42+71	1,07	1,88	2,25	3,80	9,00	(3,00-11,20)	4,09	A	8,00	▶▶▶	2,20	(0,48-3,34)	1100	10,50	1,24	2,17	2,60	4,39	10,40	(3,40-14,40)	4,86	A	4,40	▶▶	2,14	(0,46-3,63)	1070	10,10						
20+35+50+50	1,16	2,04	2,90	2,90	9,00	(3,00-11,00)	4,07	A	8,00	▶▶▶	2,21	(0,52-3,05)	1105	10,60	1,34	2,36	3,35	3,35	10,40	(3,40-14,40)	4,77	A	4,40	▶▶	2,18	(0,53-3,58)	1090	10,20						
20+35+50+60	1,09	1,91	2,73	3,27	9,00	(3,00-11,20)	4,07	A	8,00	▶▶▶	2,21	(0,52-3,20)	1105	10,60	1,26	2,21	3,15	3,78	10,40	(3,40-14,40)	4,77	A	4,40	▶▶	2,18	(0,53-3,58)	1090	10,20						
20+35+50+71	1,02	1,79	2,56	3,63	9,00	(3,00-11,20)	4,17	A	8,00	▶▶▶	2,16	(0,53-3,20)	1080	10,30	1,18	2,07	2,95	4,20	10,40	(3,40-14,40)	4,79	A	4,40	▶▶	2,17	(0,54-3,56)	1085	10,20						
20+35+60+60	1,02	1,80	3,09	3,09	9,00	(3,00-11,20)	4,07	A	8,00	▶▶▶	2,21	(0,52-3,20)	1105	10,60	1,19	2,07	3,57	3,57	10,40	(3,40-14,40)	4,77	A	4,40	▶▶	2,18	(0,53-3,58)	1090	10,20						
20+42+42+42	1,23	2,59	2,59	2,59	9,00	(3,00-11,00)	3,90	A	8,00	▶▶▶	2,31	(0,40-3,40)	1155	11,10	1,43	2,99	2,99	2,99	10,40	(3,40-14,40)	4,79	A	4,40	▶▶	2,17	(0,39-3,71)	1085	10,20						
20+42+42+50	1,17	2,45	2,45	2,93	9,00	(3,00-11,00)	4,09	A	8,00	▶▶▶	2,20	(0,45-3,19)	1100	10,50	1,35	2,84	2,84	3,37	10,40	(3,40-14,40)	4,86	A	4,40	▶▶	2,14	(0,45-3,63)	1070	10,10						
20+42+42+60	1,10	2,30	2,30	3,30	9,00	(3,00-11,20)	4,09	A	8,00	▶▶▶	2,20	(0,45-3,33)	1100	10,50	1,27	2,66	2,66	3,81	10,40	(3,40-14,40)	4,86	A	4,40	▶▶	2,14	(0,45-3,63)	1070	10,10						
20+42+42+71	1,03	2,16	2,16	3,65	9,00	(3,00-11,20)	4,09	A	8,00	▶▶▶	2,20	(0,48-3,26)	1100	10,50	1,19	2,50	2,50	4,21	10,40	(3,40-14,40)	4,79	A	4,40	▶▶	2,13	(0,46-3,61)	1065	10,10						
20+42+50+50	1,11	2,33	2,78	2,78	9,00	(3,00-11,20)	4,19	A	8,00	▶▶▶	2,15	(0,52-3,20)	1075	10,30	1,28	2,70	3,21	3,21	10,40	(3,40-14,40)	4,79	A	4,40	▶▶	2,17	(0,54-3,57)	1085	10,20						
20+42+50+60	1,04	2,20	2,62	3,14	9,00	(3,00-11,20)	4,19	A	8,00	▶▶▶	2,15	(0,52-3,20)	1075	10,30	1,21	2,54	3,02	3,63	10,40	(3,40-14,40)	4,79	A	4,40	▶▶	2,17	(0,54-3,57)	1085	10,20						
20+42+50+71	0,98	2,07	2,46	3,49	9,00	(3,00-11,20)	4,17	A	8,00	▶▶▶	2,16	(0,53-3,13)	1080	10,30	1,14	2,39	2,84	4,03	10,40	(3,40-14,40)	4,79	A	4,40	▶▶	2,17	(0,55-3,55)	1085	10,20						
20+42+60+60	0,98	2,08	2,97	2,97	9,00	(3,00-11,20)	4,19	A	8,00	▶▶▶	2,15	(0,52-3,20)	1075	10,30	1,14	2,40	3,43	3,43	10,40	(3,40-14,40)	4,79	A	4,40	▶▶	2,17	(0,54-3,57)	1085	10,20						
20+50+50+50	1,05	2,65	2,65	2,65	9,00	(3,00-11,20)	4,15	A	8,00	▶▶▶	2,17	(0,58-3,14)	1085	10,40	1,22	3,06	3,06	3,06	10,40	(3,40-14,40)	4,60	A	4,40	▶▶	2,26	(0,63-3,57)	1130	10,60						
20+50+50+60	1,00	2,50	2,50	3,00	9,00	(3,00-11,20)	4,15	A	8,00	▶▶▶	2,17	(0,58-3,14)	1085	10,40	1,16	2,89	2,89	3,46	10,40	(3,40-14,40)	4,60	A	4,40	▶▶	2,26	(0,63-3,57)	1130	10,60						
25+25+25+25	2,25	2,25	2,25	2,25	9,00	(2,90-10,60)	3,78	A	8,00	▶▶▶	2,38	(0,37-3,40)	1190	11,40	2,60	2,60	2,60	2,60	10,40	(3,40-14,20)	4,71	A	4,40	▶▶	2,21	(0,34-3,79)	1105	10,40						
25+25+25+35	2,05	2,05	2,05	2,85	9,00	(2,90-10,60)	3,78	A	8,00	▶▶▶	2,38	(0,37-3,33)	1190	11,40	2,36	2,36	2,36	2,36	10,40	(3,40-14,20)	4,75	A	4,40	▶▶	2,19	(0,35-3,76)	1095	10,30						
25+25+25+42	1,92	1,92	1,92	3,24	9,00	(2,90-10,60)	3,78	A	8,00	▶▶▶	2,38	(0,37-3,33)	1190	11,40	2,22	2,22	2,22	3,74	10,40	(3,40-14,20)	4,77	A	4,40	▶▶	2,18	(0,36-3,74)	1090	10,20						
25+25+25+50	1,80	1,80	1,80	3,60	9,00	(2,90-10,80)	4,00	A	8,00	▶▶▶	2,25	(0,41-3,18)	1125	10,80	2,08	2,08	2,08	4,16	10,40	(3,40-14,20)	4,86	A	4,40	▶▶	2,14	(0,42-3,60)	1070	10,10						
25+25+25+60	1,67	1,67	1,67	3,99	9,00	(2,90-10,80)	4,00	A	8,00	▶▶▶	2,25	(0,41-3,18)	1125	10,80	1,93	1,93	1,93	4,61	10,40	(3,40-14,40)	4,86	A	4,40	▶▶	2,14	(0,42-3,66)	1070	10,10						
25+25+25+71	1,54	1,54	1,54	4,38	9,00	(3,00-11,00)	4,09	A	8,00	▶▶▶	2,20	(0,44-3,26)	1100	10,50	1,78	1,78	1,78	5,06	10,40	(3,40-14,40)	4,88	A	4,40	▶▶	2,13	(0,42-3,64)	1065	10,00						
25+25+35+35	1,87	1,87	2,63	2,63	9,00	(2,90-10,60)	3,90	A	8,00	▶▶▶	2,31	(0,37-3,25)	1155	11,10	2,17	2,17	3,03	3,03	10,40	(3,40-14,20)	4,79	A	4,40	▶▶	2,17	(0,37-3,66)	1085	10,20						
25+25+35+42	1,77	1,77	2,48	2,98	9,00	(2,90-10,80)	3,90	A	8,00	▶▶▶	2,31	(0,37-3,40)	1155	11,10	2,05	2,05	2,87	3,43	10,40	(3,40-14,20)	4,81	A	4,40	▶▶	2,16	(0,37-3,65)	1080	10,20						
25+25+35+50	1,67	1,67	2,33	3,33	9,00	(2,90-10,80)	3,98	A	8,00	▶▶▶	2,26	(0,44-3,11)	1130	10,80	1,93	1,93	2,70	3,84	10,40	(3,40-14,40)	4,91	A	4,40	▶▶	2,12	(0,42-3,63)	1060	10,00						
25+25+35+60	1,55	1,55	2,17	3,73	9,00	(3,00-11,00)	3,98	A	8,00	▶▶▶	2,26	(0,44-3,26)	1130	10,80	1,79	1,79	2,51	4,31	10,40	(3,40-14,40)	4,91	A	4,40	▶▶	2,12	(0,42-3,63)	1060	10,00						
25+25+35+71	1,44	1,44	2,02	4,10	9,00	(3,00-11,00)	4,09	A	8,00	▶▶▶	2,20	(0,44-3,19)	1100	10,50	1,67	1,67	2,33	4,73	10,40	(3,40-14,40)	4,81	A	4,40	▶▶	2,16	(0,43-3,61)	1080	10,20						
25+25+42+42	1,68	1,68	2,82	2,82	9,00	(2,90-10,80)	3,90	A	8,00	▶▶▶	2,31	(0,37-3,40)	1155	11,10	1,94	1,94	3,26	3,26	10,40	(3,40-14,40)	4,75	A	4,40	▶▶	2,19	(0,37-3,76)	1095	10,30						
25+25+42+50	1,58	1,58	2,66	3,18	9,00	(3,00-11,00)	4,09	A	8,00	▶▶▶	2,20	(0,44-3,26)	1100	10,50	1,83	1,83	3,08	3,66	10,40	(3,40-14,40)	4,81	A	4,40	▶▶	2,16	(0,43-3,62)	1080	10,20						
25+25+42+60	1,48	1,48	2,49	3,55	9,00	(3,00-11,00)	4,09	A	8,00	▶▶▶	2,20	(0,44-3,26)	1100	10,50	1,71	1,71	2,87	4,11	10,40	(3,40-14,40)	4,81	A	4,40	▶▶	2,16	(0,43-3,62)	1080	10,20						
25+25+42+71	1,38	1,38	2,32	3,92	9,00	(3,00-11,20)	4,09	A	8,00	▶▶▶	2,20	(0,45-3,33)	1100	10,50	1,60	1,60	2,68	4,52	10,40	(3,40-14,40)	4,84	A	4,40	▶▶	2,15	(0,44-3,66)	1075	10,10						
25+25+50+50	1,50	1,50	3,00	3,00	9,00	(3,00-11,00)	4,07	A	8,00	▶▶▶	2,21	(0,49-3,12)	1105	10,60	1,73																			

FREE MULTI R32 COMBINATIONS TABLE

Free Multi 5x1 CU-5Z90TBE. Minimum capacity connected: 4,50 kW. Maximum capacity connected: 18,30 kW • R32 GAS

Indoor unit capacity	Cooling capacity(kW) Rooms					EER	SEER ¹	Input power rating			Heating capacity(kW) Rooms					COP	SCOP ¹	Input power rating								
	A	B	C	D	E			Total (Min - Max)	W/W	W/W	kW	kWh	230V	A	B			C	D	E	Total (Min - Max)	W/W	W/W	kW	kWh	230V
5 Rooms																										
16+16+16+16+16	1,60	1,60	1,60	1,60	1,60	8,00	[2,90 - 11,50]	4,28	A 8,50	1,87	(0,45 - 3,56)	935	9,00	2,08	2,08	2,08	2,08	2,08	10,40	[3,40 - 14,50]	4,81	A 4,40	2,16	(0,43 - 3,67)	1080	10,20
16+16+16+16+20	1,60	1,60	1,60	1,60	2,00	8,40	[2,90 - 11,50]	4,24	A 8,50	1,98	(0,45 - 3,56)	990	9,50	1,98	1,98	1,98	2,48	10,40	[3,40 - 14,50]	4,84	A 4,50	2,15	(0,44 - 3,66)	1075	10,10	
16+16+16+16+25	1,62	1,62	1,62	1,62	2,52	9,00	[2,90 - 11,50]	4,09	A 8,50	2,20	(0,45 - 3,56)	1100	10,50	1,87	1,87	1,87	2,92	10,40	[3,40 - 14,50]	4,84	A 4,68	2,15	(0,44 - 3,66)	1075	10,10	
16+16+16+16+35	1,45	1,45	1,45	1,45	3,20	9,00	[2,90 - 11,50]	4,09	A 8,50	2,20	(0,45 - 3,49)	1100	10,50	1,68	1,68	1,68	3,68	10,40	[3,40 - 14,50]	4,84	A 4,68	2,14	(0,45 - 3,63)	1070	10,10	
16+16+16+16+42	1,36	1,36	1,36	1,36	3,56	9,00	[2,90 - 11,50]	4,09	A 8,50	2,20	(0,45 - 3,49)	1100	10,50	1,57	1,57	1,57	4,12	10,40	[3,40 - 14,50]	4,84	A 4,68	2,14	(0,46 - 3,67)	1070	10,10	
16+16+16+16+50	1,26	1,26	1,26	1,26	3,96	9,00	[2,90 - 11,50]	4,17	A 8,50	2,16	(0,53 - 3,35)	1080	10,30	1,46	1,46	1,46	4,56	10,40	[3,40 - 14,50]	4,79	A 4,68	2,17	(0,54 - 3,61)	1085	10,20	
16+16+16+16+60	1,16	1,16	1,16	1,16	4,36	9,00	[2,90 - 11,50]	4,17	A 8,50	2,16	(0,53 - 3,35)	1080	10,30	1,34	1,34	1,34	5,04	10,40	[3,40 - 14,50]	4,79	A 4,68	2,17	(0,54 - 3,61)	1085	10,20	
16+16+16+16+71	1,07	1,07	1,07	1,07	4,72	9,00	[2,90 - 11,50]	4,17	A 8,50	2,16	(0,54 - 3,28)	1080	10,30	1,23	1,23	1,23	5,48	10,40	[3,40 - 14,50]	4,71	A 4,68	2,21	(0,56 - 3,60)	1105	10,40	
16+16+16+20+20	1,60	1,60	1,60	2,00	2,00	8,80	[2,90 - 11,50]	4,11	A 8,50	2,14	(0,45 - 3,48)	1070	10,20	1,89	1,89	1,89	2,36	2,36	10,39	[3,40 - 14,50]	4,83	A 4,60	2,15	(0,45 - 3,65)	1075	10,10
16+16+16+20+25	1,55	1,55	1,55	1,94	2,41	9,00	[2,90 - 11,50]	4,09	A 8,50	2,20	(0,45 - 3,48)	1100	10,50	1,79	1,79	1,79	2,24	2,79	10,40	[3,40 - 14,50]	4,84	A 4,68	2,15	(0,45 - 3,65)	1075	10,10
16+16+16+20+35	1,40	1,40	1,40	1,75	3,05	9,00	[2,90 - 11,50]	4,09	A 8,50	2,20	(0,45 - 3,49)	1100	10,50	1,62	1,62	1,62	2,02	3,52	10,40	[3,40 - 14,50]	4,84	A 4,68	2,14	(0,46 - 3,67)	1070	10,10
16+16+16+20+42	1,31	1,31	1,31	1,64	3,43	9,00	[2,90 - 11,50]	4,09	A 8,50	2,20	(0,48 - 3,49)	1100	10,50	1,51	1,51	1,51	1,89	3,98	10,40	[3,40 - 14,50]	4,88	A 4,68	2,13	(0,47 - 3,66)	1065	10,00
16+16+16+20+50	1,22	1,22	1,22	1,53	3,81	9,00	[2,90 - 11,50]	4,17	A 8,50	2,16	(0,53 - 3,35)	1080	10,30	1,41	1,41	1,41	1,76	4,41	10,40	[3,40 - 14,50]	4,79	A 4,68	2,17	(0,56 - 3,60)	1085	10,20
16+16+16+20+60	1,13	1,13	1,13	1,41	4,20	9,00	[2,90 - 11,50]	4,17	A 8,50	2,16	(0,53 - 3,35)	1080	10,30	1,30	1,30	1,30	1,63	4,87	10,40	[3,40 - 14,50]	4,79	A 4,68	2,17	(0,56 - 3,60)	1085	10,20
16+16+16+20+71	1,04	1,04	1,04	1,29	4,59	9,00	[2,90 - 11,50]	4,15	A 8,50	2,17	(0,54 - 3,28)	1085	10,40	1,20	1,20	1,20	1,50	5,30	10,40	[3,40 - 14,50]	4,73	A 4,68	2,20	(0,57 - 3,59)	1100	10,30
16+16+16+25+25	1,47	1,47	1,47	2,29	2,29	8,99	[2,90 - 11,50]	4,09	A 8,50	2,20	(0,45 - 3,48)	1100	10,50	1,70	1,70	1,70	2,65	2,65	10,40	[3,40 - 14,50]	4,84	A 4,68	2,15	(0,45 - 3,65)	1075	10,10
16+16+16+25+35	1,33	1,33	1,33	2,08	2,93	9,00	[2,90 - 11,50]	4,09	A 8,50	2,20	(0,45 - 3,49)	1100	10,50	1,54	1,54	1,54	2,41	3,37	10,40	[3,40 - 14,50]	4,84	A 4,68	2,14	(0,46 - 3,67)	1070	10,10
16+16+16+25+42	1,25	1,25	1,25	1,96	3,29	9,00	[2,90 - 11,50]	4,09	A 8,50	2,20	(0,48 - 3,49)	1100	10,50	1,45	1,45	1,45	2,26	3,79	10,40	[3,40 - 14,50]	4,88	A 4,68	2,13	(0,47 - 3,66)	1065	10,00
16+16+16+25+50	1,17	1,17	1,17	1,83	3,66	9,00	[2,90 - 11,50]	4,17	A 8,50	2,16	(0,53 - 3,35)	1080	10,30	1,35	1,35	1,35	2,11	4,24	10,40	[3,40 - 14,50]	4,79	A 4,68	2,17	(0,56 - 3,60)	1085	10,20
16+16+16+25+60	1,08	1,08	1,08	1,69	4,07	9,00	[2,90 - 11,50]	4,17	A 8,50	2,16	(0,53 - 3,35)	1080	10,30	1,25	1,25	1,25	1,95	4,70	10,40	[3,40 - 14,50]	4,79	A 4,68	2,17	(0,56 - 3,60)	1085	10,20
16+16+16+25+71	1,00	1,00	1,00	1,56	4,44	9,00	[2,90 - 11,50]	4,15	A 8,50	2,17	(0,54 - 3,28)	1085	10,40	1,16	1,16	1,16	1,81	5,11	10,40	[3,40 - 14,50]	4,73	A 4,68	2,20	(0,57 - 3,59)	1100	10,30
16+16+16+35+35	1,22	1,22	1,22	2,67	2,67	9,00	[2,90 - 11,50]	4,07	A 8,50	2,21	(0,48 - 3,41)	1105	10,60	1,41	1,41	1,41	3,08	3,08	10,39	[3,40 - 14,50]	4,81	A 4,68	2,16	(0,48 - 3,64)	1080	10,20
16+16+16+35+42	1,15	1,15	1,15	2,52	3,03	9,00	[2,90 - 11,50]	4,07	A 8,50	2,21	(0,48 - 3,41)	1105	10,60	1,33	1,33	1,33	2,91	3,50	10,40	[3,40 - 14,50]	4,81	A 4,68	2,16	(0,49 - 3,63)	1080	10,20
16+16+16+35+50	1,08	1,08	1,08	2,37	3,39	9,00	[2,90 - 11,50]	4,15	A 8,50	2,17	(0,54 - 3,28)	1085	10,40	1,25	1,25	1,25	2,74	3,91	10,40	[3,40 - 14,50]	4,73	A 4,68	2,20	(0,57 - 3,63)	1100	10,30
16+16+16+35+60	1,01	1,01	1,01	2,20	3,77	9,00	[2,90 - 11,50]	4,15	A 8,50	2,17	(0,54 - 3,28)	1085	10,40	1,16	1,16	1,16	2,55	4,37	10,40	[3,40 - 14,50]	4,73	A 4,68	2,20	(0,57 - 3,63)	1100	10,30
16+16+16+35+71	0,94	0,94	0,94	2,05	4,13	9,00	[2,90 - 11,50]	4,15	A 8,50	2,17	(0,57 - 3,28)	1085	10,40	1,08	1,08	1,08	2,36	4,80	10,40	[3,40 - 14,50]	4,73	A 4,68	2,20	(0,59 - 3,62)	1100	10,30
16+16+16+42+42	1,09	1,09	1,09	2,86	2,86	8,99	[2,90 - 11,50]	4,07	A 8,50	2,21	(0,49 - 3,41)	1105	10,60	1,26	1,26	1,26	3,31	3,31	10,40	[3,40 - 14,50]	4,84	A 4,68	2,15	(0,50 - 3,62)	1075	10,10
16+16+16+42+50	1,03	1,03	1,03	2,70	3,21	9,00	[2,90 - 11,50]	4,15	A 8,50	2,17	(0,54 - 3,28)	1085	10,40	1,19	1,19	1,19	3,12	3,71	10,40	[3,40 - 14,50]	4,73	A 4,68	2,20	(0,59 - 3,62)	1100	10,30
16+16+16+42+60	0,96	0,96	0,96	2,52	3,60	9,00	[2,90 - 11,50]	4,15	A 8,50	2,17	(0,54 - 3,28)	1085	10,40	1,11	1,11	1,11	2,91	4,16	10,40	[3,40 - 14,50]	4,73	A 4,68	2,20	(0,59 - 3,62)	1100	10,30
16+16+16+42+71	0,89	0,89	0,89	2,35	3,98	9,00	[2,90 - 11,50]	4,15	A 8,50	2,17	(0,57 - 3,29)	1085	10,40	1,03	1,03	1,03	2,71	4,60	10,40	[3,40 - 14,50]	4,66	A 4,68	2,23	(0,60 - 3,61)	1115	10,50
16+16+16+50+50	0,97	0,97	0,97	3,04	3,05	9,00	[2,90 - 11,50]	4,11	A 8,50	2,19	(0,62 - 3,23)	1095	10,50	1,12	1,12	1,12	3,52	3,52	10,40	[3,40 - 14,50]	4,54	A 4,68	2,29	(0,69 - 3,63)	1145	10,80
16+16+16+50+60	0,91	0,91	0,91	2,85	3,42	9,00	[2,90 - 11,50]	4,11	A 8,50	2,19	(0,62 - 3,23)	1095	10,50	1,05	1,05	1,05	3,29	3,96	10,40	[3,40 - 14,50]	4,54	A 4,68	2,29	(0,69 - 3,63)	1145	10,80
16+16+16+50+71	0,85	0,85	0,85	2,66	3,79	9,00	[2,90 - 11,50]	3,98	A 8,50	2,26	(0,66 - 3,24)	1130	10,80	0,98	0,98	0,98	3,08	4,38	10,40	[3,40 - 14,50]	4,54	A 4,68	2,29	(0,71 - 3,62)	1145	10,80
16+16+16+60+60	0,86	0,86	0,86	3,21	3,21	9,00	[2,90 - 11,50]	4,11	A 8,50	2,19	(0,62 - 3,23)	1095	10,50	0,99	0,99	0,99	3,71	3,71	10,39	[3,40 - 14,50]	4,54	A 4,68	2,29	(0,69 - 3,63)	1145	10,80
16+16+16+60+71	0,80	0,80	0,80	3,02	3,58	9,00	[2,90 - 11,50]	3,98	A 8,50	2,26	(0,66 - 3,24)	1130	10,80	0,93	0,93	0,93	3,49	4,12	10,40	[3,40 - 14,50]	4,54	A 4,68	2,29	(0,71 - 3,62)	1145	10,80
16+16+20+20+20	1,56	1,56	1,56	1,96	1,96	9,00	[2,90 - 11,50]	4,09	A 8,50	2,20	(0,45 - 3,49)	1100	10,50	1,81	1,81	2,26	2,26	2,26	10,40	[3,40 - 14,50]	4,84	A 4,68	2,14	(0,45 - 3,64)	1070	10,10
16+16+20+20+25	1,48	1,48	1,48	1,86	2,32	9,00	[2,90 - 11,50]	4,09	A 8,50	2,20	(0,45 - 3,49)	1100	10,50	1,72	1,72	2,14	2,14	2,68	10,40	[3,40 - 14,50]	4,84	A 4,68	2,14	(0,45 - 3,64)	1070	10,10
16+16+20+20+35	1,35	1,35	1,35	1,68	2,94	9,00	[2,90 - 11,50]	4,09	A 8,50	2,20	(0,48 - 3,49)	1100	10,50	1,56	1,56	1,94	1,94	3,40	10,40	[

Free Multi System Z

R32

Free Multi 5x1 CU-5Z90TBE. Minimum capacity connected: 4,50 kW. Maximum capacity connected: 18,30 kW • R32 GAS

Indoor unit capacity	Cooling capacity (kW) Rooms					EER	SEER¹	Input power rating			A.E.C.	Current	Heating capacity (kW) Rooms					COP	SCOP¹	Input power rating			A.E.C.	Current
	A	B	C	D	E			Total (Min - Max)	W/W	W/W			kWh	kWh	230V	A	B			C	D	E		
16+16+25+50+71	0,81	0,81	1,26	2,53	3,59	9,00(2,90-11,50)	3,96	A 8,50	2,27(0,66-3,24)	1135	10,90	0,93	0,93	1,46	2,92	4,16	10,40(3,40-14,50)	4,46	A 4,68	2,33(0,71-3,66)	1165	10,90		
16+16+25+60+60	0,81	0,81	1,28	3,05	3,05	9,00(2,90-11,50)	3,98	A 8,50	2,26(0,63-3,23)	1130	10,80	0,94	0,94	1,46	3,53	3,53	10,40(3,40-14,50)	4,54	A 4,68	2,29(0,70-3,62)	1145	10,80		
16+16+35+35+35	1,05	1,05	2,30	2,30	2,30	9,00(2,90-11,50)	4,07	A 8,50	2,21(0,49-3,42)	1105	10,60	1,21	1,21	2,66	2,66	2,66	10,40(3,40-14,50)	4,77	A 4,68	2,15(0,51-3,60)	1075	10,10		
16+16+35+35+42	1,00	1,00	2,19	2,19	2,62	9,00(2,90-11,50)	4,07	A 8,50	2,21(0,49-3,42)	1105	10,60	1,16	1,16	2,53	2,53	3,02	10,40(3,40-14,50)	4,84	A 4,68	2,18(0,51-3,59)	1090	10,20		
16+16+35+35+50	0,95	0,95	2,07	2,07	2,96	9,00(2,90-11,50)	4,15	A 8,50	2,17(0,57-3,28)	1085	10,40	1,09	1,09	2,39	2,39	3,44	10,40(3,40-14,50)	4,66	A 4,68	2,23(0,61-3,59)	1115	10,50		
16+16+35+35+60	0,89	0,89	1,94	1,94	3,34	9,00(2,90-11,50)	4,15	A 8,50	2,17(0,57-3,28)	1085	10,40	1,03	1,03	2,25	2,25	3,84	10,40(3,40-14,50)	4,66	A 4,68	2,23(0,61-3,59)	1115	10,50		
16+16+35+35+71	0,83	0,83	1,82	1,82	3,70	9,00(2,90-11,50)	4,13	A 8,50	2,18(0,58-3,29)	1090	10,40	0,96	0,96	2,10	2,10	4,28	10,40(3,40-14,50)	4,66	A 4,68	2,23(0,62-3,58)	1115	10,50		
16+16+42+42+42	0,95	0,95	2,10	2,10	2,50	9,00(2,90-11,50)	4,07	A 8,50	2,21(0,49-3,34)	1105	10,60	1,10	1,10	2,42	2,89	2,89	10,40(3,40-14,50)	4,77	A 4,68	2,18(0,52-3,64)	1090	10,20		
16+16+42+42+50	0,91	0,91	1,98	2,38	2,82	9,00(2,90-11,50)	4,15	A 8,50	2,17(0,57-3,29)	1085	10,40	1,05	1,05	2,29	2,75	3,26	10,40(3,40-14,50)	4,66	A 4,68	2,23(0,62-3,59)	1115	10,50		
16+16+42+42+60	0,85	0,85	1,86	2,24	3,20	9,00(2,90-11,50)	4,15	A 8,50	2,17(0,57-3,29)	1085	10,40	0,98	0,98	2,15	2,58	3,71	10,40(3,40-14,50)	4,66	A 4,68	2,23(0,62-3,59)	1115	10,50		
16+16+42+42+71	0,80	0,80	1,75	2,10	3,55	9,00(2,90-11,50)	4,13	A 8,50	2,18(0,58-3,29)	1090	10,40	0,92	0,92	2,02	2,43	4,11	10,40(3,40-14,50)	4,68	A 4,68	2,22(0,63-3,63)	1110	10,40		
16+16+42+42+80	0,86	0,86	1,90	2,69	2,69	9,00(2,90-11,50)	3,98	A 8,50	2,26(0,66-3,24)	1130	10,80	1,00	1,00	2,18	3,11	3,11	10,40(3,40-14,50)	4,46	A 4,68	2,33(0,72-3,65)	1165	10,90		
16+16+42+42+90	0,81	0,81	1,78	2,54	3,06	9,00(2,90-11,50)	3,98	A 8,50	2,26(0,66-3,24)	1130	10,80	0,94	0,94	2,06	2,94	3,52	10,40(3,40-14,50)	4,46	A 4,68	2,33(0,72-3,65)	1165	10,90		
16+16+42+42+100	0,91	0,91	2,39	2,39	2,39	8,99(2,90-11,50)	4,18	A 8,50	2,15(0,49-3,34)	1075	10,30	1,06	1,06	2,76	2,76	2,76	10,40(3,40-14,50)	4,77	A 4,68	2,18(0,53-3,63)	1090	10,20		
16+16+42+42+110	0,87	0,87	2,28	2,28	2,70	9,00(2,90-11,50)	4,15	A 8,50	2,17(0,57-3,29)	1085	10,40	1,00	1,00	2,63	2,63	3,14	10,40(3,40-14,50)	4,66	A 4,68	2,23(0,63-3,63)	1115	10,50		
16+16+42+42+120	0,82	0,82	2,15	2,15	3,06	9,00(2,90-11,50)	4,15	A 8,50	2,17(0,57-3,29)	1085	10,40	0,95	0,95	2,48	2,48	3,54	10,40(3,40-14,50)	4,66	A 4,68	2,23(0,63-3,63)	1115	10,50		
16+16+42+42+130	0,83	0,83	2,16	2,59	2,59	9,00(2,90-11,50)	3,96	A 8,50	2,27(0,66-3,24)	1135	10,90	0,96	0,96	2,50	2,99	2,99	10,40(3,40-14,50)	4,46	A 4,68	2,33(0,74-3,65)	1165	10,90		
16+16+50+50+50	0,79	0,79	2,47	2,47	2,47	8,99(2,90-11,50)	3,91	A 8,50	2,30(0,76-3,27)	1150	11,00	0,91	0,91	2,86	2,86	2,86	10,40(3,40-14,50)	4,19	A 4,68	2,48(0,86-3,73)	1240	11,70		
16+20+20+20+20	1,48	1,88	1,88	1,88	1,88	9,00(2,90-11,50)	4,09	A 8,50	2,20(0,45-3,49)	1100	10,50	1,72	1,72	1,17	2,17	2,17	10,40(3,40-14,50)	4,86	A 4,68	2,14(0,46-3,68)	1070	10,10		
16+20+20+20+25	1,43	1,78	1,78	2,23	2,23	9,00(2,90-11,50)	4,09	A 8,50	2,20(0,45-3,49)	1100	10,50	1,65	1,65	2,06	2,06	2,57	10,40(3,40-14,50)	4,86	A 4,68	2,14(0,46-3,68)	1070	10,10		
16+20+20+20+35	1,30	1,62	1,62	1,62	2,84	9,00(2,90-11,50)	4,09	A 8,50	2,20(0,48-3,41)	1100	10,50	1,50	1,87	1,87	1,87	3,29	10,40(3,40-14,50)	4,79	A 4,68	2,17(0,48-3,65)	1085	10,20		
16+20+20+20+42	1,22	1,53	1,53	1,53	3,19	9,00(2,90-11,50)	4,07	A 8,50	2,21(0,48-3,41)	1105	10,60	1,41	1,76	1,76	1,76	3,71	10,40(3,40-14,50)	4,81	A 4,68	2,16(0,48-3,64)	1080	10,20		
16+20+20+20+50	1,14	1,43	1,43	1,43	3,57	9,00(2,90-11,50)	4,17	A 8,50	2,16(0,54-3,28)	1080	10,30	1,32	1,65	1,65	1,65	4,13	10,40(3,40-14,50)	4,73	A 4,68	2,20(0,57-3,58)	1100	10,30		
16+20+20+20+60	1,06	1,32	1,32	1,32	3,98	9,00(2,90-11,50)	4,17	A 8,50	2,16(0,54-3,28)	1080	10,30	1,22	1,53	1,53	1,53	4,59	10,40(3,40-14,50)	4,73	A 4,68	2,20(0,57-3,58)	1100	10,30		
16+20+20+20+71	0,98	1,22	1,22	1,22	4,36	9,00(2,90-11,50)	4,15	A 8,50	2,17(0,57-3,28)	1085	10,40	1,13	1,41	1,41	1,41	5,04	10,40(3,40-14,50)	4,73	A 4,68	2,20(0,58-3,62)	1100	10,30		
16+20+20+20+80	1,36	1,70	1,70	2,12	2,12	9,00(2,90-11,50)	4,09	A 8,50	2,20(0,45-3,49)	1100	10,50	1,58	1,96	1,96	2,45	2,45	10,40(3,40-14,50)	4,86	A 4,68	2,14(0,46-3,68)	1070	10,10		
16+20+20+20+90	1,24	1,55	1,55	1,94	2,72	9,00(2,90-11,50)	4,09	A 8,50	2,20(0,48-3,41)	1100	10,50	1,43	1,79	1,79	2,24	3,15	10,40(3,40-14,50)	4,79	A 4,68	2,17(0,48-3,65)	1085	10,20		
16+20+20+20+100	1,17	1,46	1,46	1,83	3,08	9,00(2,90-11,50)	4,07	A 8,50	2,21(0,48-3,41)	1105	10,60	1,35	1,69	1,69	2,11	3,56	10,40(3,40-14,50)	4,81	A 4,68	2,16(0,48-3,64)	1080	10,20		
16+20+20+20+110	1,10	1,37	1,37	1,72	3,44	9,00(2,90-11,50)	4,17	A 8,50	2,16(0,54-3,28)	1080	10,30	1,27	1,59	1,59	1,98	3,97	10,40(3,40-14,50)	4,73	A 4,68	2,20(0,57-3,58)	1100	10,30		
16+20+20+20+120	1,00	1,28	1,28	1,60	3,82	9,00(2,90-11,50)	4,17	A 8,50	2,16(0,54-3,28)	1080	10,30	1,18	1,48	1,48	1,84	4,42	10,40(3,40-14,50)	4,73	A 4,68	2,20(0,57-3,58)	1100	10,30		
16+20+20+20+130	0,95	1,18	1,18	1,48	4,21	9,00(2,90-11,50)	4,15	A 8,50	2,17(0,57-3,28)	1085	10,40	1,09	1,37	1,37	1,71	4,86	10,40(3,40-14,50)	4,73	A 4,68	2,20(0,58-3,62)	1100	10,30		
16+20+20+20+140	1,14	1,43	1,43	2,50	2,50	9,00(2,90-11,50)	4,07	A 8,50	2,21(0,49-3,41)	1105	10,60	1,32	1,65	1,65	2,89	2,89	10,40(3,40-14,50)	4,84	A 4,68	2,15(0,51-3,62)	1075	10,10		
16+20+20+20+150	1,08	1,35	1,35	2,37	2,85	9,00(2,90-11,50)	4,07	A 8,50	2,21(0,49-3,42)	1105	10,60	1,25	1,56	1,56	2,74	3,29	10,40(3,40-14,50)	4,84	A 4,68	2,15(0,51-3,61)	1075	10,10		
16+20+20+20+160	1,02	1,28	1,28	2,23	3,19	9,00(2,90-11,50)	4,15	A 8,50	2,17(0,57-3,28)	1085	10,40	1,18	1,48	1,48	2,58	3,68	10,40(3,40-14,50)	4,75	A 4,68	2,19(0,60-3,61)	1095	10,30		
16+20+20+20+170	0,95	1,19	1,19	2,09	3,58	9,00(2,90-11,50)	4,15	A 8,50	2,17(0,57-3,28)	1085	10,40	1,10	1,38	1,38	2,41	4,13	10,40(3,40-14,50)	4,75	A 4,68	2,19(0,60-3,61)	1095	10,30		
16+20+20+20+180	0,89	1,11	1,11	1,94	3,95	9,00(2,90-11,50)	4,13	A 8,50	2,18(0,58-3,29)	1090	10,40	1,03	1,28	1,28	2,25	4,56	10,40(3,40-14,50)	4,66	A 4,68	2,23(0,60-3,60)	1115	10,50		
16+20+20+20+190	1,02	1,29	1,29	2,70	2,70	9,00(2,90-11,50)	4,07	A 8,50	2,21(0,49-3,42)	1105	10,60	1,18	1,49	1,49	3,12	3,12	10,40(3,40-14,50)	4,84	A 4,68	2,15(0,51-3,60)	1075	10,10		
16+20+20+20+200	0,97	1,22	1,22	2,55	3,04	9,00(2,90-11,50)	4,15	A 8,50	2,17(0,57-3,28)	1085	10,40	1,12	1,41	1,41	2,95	3,51	10,40(3,40-14,50)	4,66	A 4,68	2,23(0,60-3,60)	1115	10,50		
16+20+20+20+210	0,91	1,14	1,14	2,39	3,42	9,00(2,90-11,50)	4,15	A 8,50	2,17(0,57-3,28)	1085	10,40	1,05	1,32	1,32	2,76	3,95	10,40(3,40-14,50)	4,66	A 4,68	2,23(0,60-3,60)	1115	10,50		
16+20+20+20+220	0,85	1,07	1,07	2,24	3,77	9,00(2,90-11,50)	4,13	A 8,50	2,18(0,58-3,29)	1090	10,40	0,98	1,23	1,23	2,58	4,38	10,40(3,40-14,50)	4,66	A 4,68	2,23(0,62-3,59)	1115	10,50		
16+20+20+20+230	0,94																							

FREE MULTI R32 COMBINATIONS TABLE

Free Multi 5x1 CU-5Z90TBE. Minimum capacity connected: 4,50 kW. Maximum capacity connected: 18,30 kW • R32 GAS

Indoor unit capacity	Cooling capacity(kW) Rooms										EER	SEER ¹	Input power A.E.C. Current			Heating capacity(kW) Rooms										COP	SCOP ¹	Input power A.E.C. Current		
	A	B	C	D	E	Total (Min - Max)	W/W	W/W	kW	230V			A	B	C	D	E	Total (Min - Max)	W/W	W/W	kW	kWh	230V							
16+25+25+25+50	1,02	1,60	1,60	3,18	9,00	[2,90 - 11,50]	4,17	A 8,50	2,16	[0,54 - 3,28]	1080	10,30	1,18	1,84	1,84	1,84	3,70	10,40	[3,40 - 14,50]	4,73	A 4,68	2,20	[0,57 - 3,58]	1100	10,30					
16+25+25+25+60	0,95	1,49	1,49	1,49	3,58	9,00	[2,90 - 11,50]	4,17	A 8,50	2,16	[0,54 - 3,28]	1080	10,30	1,10	1,72	1,72	1,72	4,14	10,40	[3,40 - 14,50]	4,73	A 4,68	2,20	[0,57 - 3,58]	1100	10,30				
16+25+25+25+71	0,89	1,39	1,39	1,39	3,94	9,00	[2,90 - 11,50]	4,15	A 8,50	2,17	[0,57 - 3,28]	1085	10,40	1,03	1,60	1,60	1,60	4,57	10,40	[3,40 - 14,50]	4,73	A 4,68	2,20	[0,58 - 3,62]	1100	10,30				
16+25+25+35+35	1,06	1,65	1,65	2,32	2,32	9,00	[2,90 - 11,50]	4,07	A 8,50	2,21	[0,49 - 3,41]	1105	10,60	1,22	1,91	1,91	2,68	2,68	10,40	[3,40 - 14,50]	4,84	A 4,68	2,15	[0,50 - 3,62]	1075	10,10				
16+25+25+35+42	1,01	1,57	1,57	2,20	2,65	9,00	[2,90 - 11,50]	4,07	A 8,50	2,21	[0,49 - 3,42]	1105	10,60	1,16	1,82	1,82	2,55	3,05	10,40	[3,40 - 14,50]	4,84	A 4,68	2,15	[0,51 - 3,61]	1075	10,10				
16+25+25+35+50	0,95	1,49	1,49	2,09	2,98	9,00	[2,90 - 11,50]	4,15	A 8,50	2,17	[0,57 - 3,28]	1085	10,40	1,10	1,72	1,72	2,41	3,45	10,40	[3,40 - 14,50]	4,75	A 4,68	2,19	[0,60 - 3,61]	1095	10,30				
16+25+25+35+60	0,89	1,40	1,40	1,96	3,35	9,00	[2,90 - 11,50]	4,15	A 8,50	2,17	[0,57 - 3,28]	1085	10,40	1,03	1,61	1,61	2,26	3,89	10,40	[3,40 - 14,50]	4,75	A 4,68	2,19	[0,60 - 3,61]	1095	10,30				
16+25+25+35+71	0,84	1,31	1,31	1,83	3,71	9,00	[2,90 - 11,50]	4,13	A 8,50	2,18	[0,58 - 3,29]	1090	10,40	0,97	1,51	1,51	2,12	4,29	10,40	[3,40 - 14,50]	4,66	A 4,68	2,23	[0,60 - 3,60]	1115	10,50				
16+25+25+42+42	0,96	1,50	1,50	2,52	2,52	9,00	[2,90 - 11,50]	4,07	A 8,50	2,21	[0,49 - 3,42]	1105	10,60	1,12	1,73	1,73	2,91	2,91	10,40	[3,40 - 14,50]	4,84	A 4,68	2,15	[0,51 - 3,60]	1075	10,10				
16+25+25+42+50	0,91	1,42	1,42	2,39	2,86	9,00	[2,90 - 11,50]	4,15	A 8,50	2,17	[0,57 - 3,28]	1085	10,40	1,05	1,65	1,65	2,76	3,29	10,40	[3,40 - 14,50]	4,66	A 4,68	2,23	[0,60 - 3,60]	1115	10,50				
16+25+25+42+60	0,86	1,34	1,34	2,25	3,21	9,00	[2,90 - 11,50]	4,15	A 8,50	2,17	[0,57 - 3,28]	1085	10,40	0,99	1,55	1,55	2,60	3,71	10,40	[3,40 - 14,50]	4,66	A 4,68	2,23	[0,60 - 3,60]	1115	10,50				
16+25+25+42+71	0,80	1,26	1,26	2,11	3,57	9,00	[2,90 - 11,50]	4,13	A 8,50	2,18	[0,58 - 3,29]	1090	10,40	0,93	1,45	1,45	2,44	4,13	10,40	[3,40 - 14,50]	4,66	A 4,68	2,23	[0,62 - 3,59]	1115	10,50				
16+25+25+50+50	0,86	1,36	1,36	2,71	2,71	9,00	[2,90 - 11,50]	3,98	A 8,50	2,26	[0,63 - 3,23]	1130	10,80	1,00	1,57	1,57	3,13	3,13	10,40	[3,40 - 14,50]	4,46	A 4,68	2,33	[0,71 - 3,61]	1165	10,90				
16+25+25+50+60	0,82	1,28	1,28	2,56	3,06	9,00	[2,90 - 11,50]	3,98	A 8,50	2,26	[0,63 - 3,23]	1130	10,80	0,95	1,48	1,48	2,95	3,54	10,40	[3,40 - 14,50]	4,46	A 4,68	2,33	[0,71 - 3,61]	1165	10,90				
16+25+35+35+35	0,99	1,53	2,16	2,16	2,16	9,00	[2,90 - 11,50]	4,07	A 8,50	2,21	[0,49 - 3,34]	1105	10,60	1,14	1,79	2,49	2,49	2,49	10,40	[3,40 - 14,50]	4,77	A 4,68	2,18	[0,51 - 3,59]	1090	10,20				
16+25+35+35+42	0,94	1,47	2,06	2,06	2,47	9,00	[2,90 - 11,50]	4,19	A 8,50	2,15	[0,49 - 3,34]	1075	10,30	1,09	1,70	2,38	2,38	2,85	10,40	[3,40 - 14,50]	4,77	A 4,68	2,18	[0,52 - 3,64]	1090	10,20				
16+25+35+35+50	0,89	1,40	1,96	1,96	2,79	9,00	[2,90 - 11,50]	4,15	A 8,50	2,17	[0,57 - 3,29]	1085	10,40	1,03	1,61	2,26	2,26	3,24	10,40	[3,40 - 14,50]	4,66	A 4,68	2,23	[0,62 - 3,59]	1115	10,50				
16+25+35+35+60	0,84	1,32	1,84	1,84	3,16	9,00	[2,90 - 11,50]	4,15	A 8,50	2,17	[0,57 - 3,29]	1085	10,40	0,97	1,52	2,13	2,13	3,65	10,40	[3,40 - 14,50]	4,66	A 4,68	2,23	[0,62 - 3,59]	1115	10,50				
16+25+35+35+71	0,79	1,24	1,73	1,73	3,51	9,00	[2,90 - 11,50]	4,13	A 8,50	2,18	[0,58 - 3,29]	1090	10,40	0,91	1,43	2,00	2,00	4,06	10,40	[3,40 - 14,50]	4,68	A 4,68	2,22	[0,63 - 3,63]	1110	10,40				
16+25+35+42+42	0,90	1,41	1,97	2,36	2,36	9,00	[2,90 - 11,50]	4,19	A 8,50	2,15	[0,49 - 3,34]	1075	10,30	1,03	1,63	2,28	2,73	2,73	10,40	[3,40 - 14,50]	4,77	A 4,68	2,18	[0,53 - 3,63]	1090	10,20				
16+25+35+42+50	0,86	1,34	1,88	2,25	2,67	9,00	[2,90 - 11,50]	4,13	A 8,50	2,18	[0,58 - 3,29]	1090	10,40	0,99	1,55	2,17	2,60	3,09	10,40	[3,40 - 14,50]	4,66	A 4,68	2,23	[0,63 - 3,63]	1115	10,50				
16+25+35+42+60	0,81	1,26	1,77	2,12	3,04	9,00	[2,90 - 11,50]	4,13	A 8,50	2,18	[0,58 - 3,29]	1090	10,40	0,93	1,46	2,04	2,45	3,52	10,40	[3,40 - 14,50]	4,66	A 4,68	2,23	[0,63 - 3,63]	1115	10,50				
16+25+35+50+50	0,82	1,28	1,78	2,56	2,56	9,00	[2,90 - 11,50]	3,96	A 8,50	2,27	[0,66 - 3,24]	1135	10,90	0,95	1,48	2,07	2,95	2,95	10,40	[3,40 - 14,50]	4,46	A 4,68	2,33	[0,74 - 3,65]	1165	10,90				
16+25+42+42+42	0,86	1,36	2,26	2,26	2,26	9,00	[2,90 - 11,50]	4,19	A 8,50	2,15	[0,52 - 3,34]	1075	10,30	0,98	1,56	2,62	2,62	2,62	10,40	[3,40 - 14,50]	4,79	A 4,68	2,17	[0,54 - 3,62]	1085	10,20				
16+25+42+42+50	0,82	1,29	2,16	2,16	2,57	9,00	[2,90 - 11,50]	4,13	A 8,50	2,18	[0,58 - 3,29]	1090	10,40	0,95	1,49	2,50	2,50	2,96	10,40	[3,40 - 14,50]	4,60	A 4,68	2,26	[0,63 - 3,62]	1130	10,60				
16+25+42+50+50	0,79	1,23	2,06	2,46	2,46	9,00	[2,90 - 11,50]	3,96	A 8,50	2,27	[0,67 - 3,24]	1135	10,90	0,91	1,42	2,39	2,84	2,84	10,40	[3,40 - 14,50]	4,41	A 4,68	2,36	[0,75 - 3,62]	1180	11,10				
16+35+35+35+35	0,92	2,02	2,02	2,02	2,02	9,00	[2,90 - 11,50]	4,19	A 8,50	2,15	[0,52 - 3,35]	1075	10,30	1,08	2,33	2,33	2,33	2,33	10,40	[3,40 - 14,50]	4,79	A 4,68	2,17	[0,54 - 3,62]	1085	10,20				
16+35+35+35+42	0,88	1,93	1,93	1,93	2,33	9,00	[2,90 - 11,50]	4,17	A 8,50	2,16	[0,52 - 3,35]	1080	10,30	1,02	2,23	2,23	2,23	2,69	10,40	[3,40 - 14,50]	4,79	A 4,68	2,17	[0,54 - 3,61]	1085	10,20				
16+35+35+35+50	0,84	1,84	1,84	1,84	2,64	9,00	[2,90 - 11,50]	4,13	A 8,50	2,18	[0,58 - 3,29]	1090	10,40	0,97	2,13	2,13	2,13	3,04	10,40	[3,40 - 14,50]	4,60	A 4,68	2,26	[0,65 - 3,62]	1130	10,60				
16+35+35+35+60	0,80	1,74	1,74	1,74	2,98	9,00	[2,90 - 11,50]	4,13	A 8,50	2,18	[0,58 - 3,29]	1090	10,40	0,92	2,01	2,01	2,01	3,45	10,40	[3,40 - 14,50]	4,60	A 4,68	2,26	[0,65 - 3,62]	1130	10,60				
16+35+35+42+42	0,86	1,85	1,85	2,22	2,22	9,00	[2,90 - 11,50]	4,17	A 8,50	2,16	[0,53 - 3,35]	1080	10,30	0,98	2,14	2,14	2,57	2,57	10,40	[3,40 - 14,50]	4,79	A 4,68	2,17	[0,55 - 3,60]	1085	10,20				
16+35+35+42+50	0,81	1,77	1,77	2,12	2,53	9,00	[2,90 - 11,50]	4,13	A 8,50	2,18	[0,58 - 3,29]	1090	10,40	0,93	2,04	2,04	2,45	2,94	10,40	[3,40 - 14,50]	4,60	A 4,68	2,26	[0,65 - 3,61]	1130	10,60				
16+35+42+42+42	0,81	1,77	2,14	2,14	2,14	9,00	[2,90 - 11,50]	4,17	A 8,50	2,16	[0,53 - 3,35]	1080	10,30	0,93	2,06	2,47	2,47	2,47	10,40	[3,40 - 14,50]	4,73	A 4,68	2,20	[0,56 - 3,59]	1100	10,30				
20+20+20+20+20	1,80	1,80	1,80	1,80	1,80	9,00	[2,90 - 11,50]	4,09	A 8,50	2,20	[0,48 - 3,49]	1100	10,50	2,08	2,08	2,08	2,08	2,08	10,40	[3,40 - 14,50]	4,88	A 4,68	2,13	[0,46 - 3,67]	1065	10,00				
20+20+20+20+25	1,71	1,71	1,71	1,71	2,16	9,00	[2,90 - 11,50]	4,09	A 8,50	2,20	[0,48 - 3,49]	1100	10,50	1,98	1,98	1,98	1,98	2,48	10,40	[3,40 - 14,50]	4,88	A 4,68	2,13	[0,46 - 3,67]	1065	10,00				
20+20+20+20+35	1,57	1,57	1,57	1,57	2,72	9,00	[2,90 - 11,50]	4,07	A 8,50	2,21	[0,48 - 3,41]	1105	10,60	1,81	1,81	1,81	1,81	3,16	10,40	[3,40 - 14,50]	4,81	A 4,68	2,16	[0,48 - 3,64]	1080	10,20				
20+20+20+20+42	1,48	1,48	1,48	1,48	3,08	9,00	[2,90 - 11,50]	4,07	A 8,50	2,21	[0,49 - 3,41]	1105	10,60	1,70	1,70	1,70	1,70	3,60	10,40	[3,40 - 14,50]	4,81	A 4,68	2,16	[0,49 - 3,63]	1080	10,20				
20+20+20+20+50	1,38	1,38	1,38	1,38	3,48	9,00	[2,90 - 11,50]	4,15	A 8,50	2,17	[0,54 - 3,28]	1085	10,40	1,60	1,60	1,60	1,60	4,00	10,40	[3,40 - 14,50]	4,73	A 4,68	2,20	[0,58 - 3,63]	1100	10,30				
20+20+20+20+60	1,29	1,29	1,29	1,29	3,84	9,00	[2,90 - 11,50]	4,15	A 8,50	2,17	[0,54 - 3,28]	1085	10,40	1,49	1,49	1,49	1,49	4,44	10,40	[3,40 - 14,50]	4,73	A 4,68	2,20	[0,58 - 3,63]	1100	10,30				
20+20+20+20+71	1,19	1,19	1,19	1,19	4,24	9,00	[2,90 - 11,50]	4,15	A 8,50	2,17	[0,57 - 3,28]	1085	10,40	1,38	1,38	1,38	1,38	4,88	10,40	[3,40 - 14,50]	4,75	A 4,68	2,19	[0,59 - 3,61]	1095	10,30				
20+20+20+25+25	1,64	1,64	1,64	2,04	2,04	9,00	[2,90 - 11,50]	4,09	A 8,50	2,20	[0,48 - 3,49]	1100	10,50	1,89	1,89	1,89	2,36	2,36	10,40	[3,40 -										

Free Multi 5x1 CU-5Z90TBE. Minimum capacity connected: 4,50 kW. Maximum capacity connected: 18,30 kW • R32 GAS

Indoor unit capacity	Cooling capacity (kW) Rooms					EER	SEER ¹	Input power rating			A.E.C.	Current	Heating capacity (kW) Rooms					COP	SCOP ¹	Input power rating			A.E.C.	Current										
	A	B	C	D	E			Total (Min - Max)	W/W	W/W			kW	kWh	230V	A	B			C	D	E			Total (Min - Max)	W/W	W/W	kW	kWh	230V				
20+20+35+35+71	0,99	0,99	1,74	1,74	3,54	9,00	2,90	-11,50	4,13	A	8,50	4,68	2,18	0,61	-3,29	1090	10,40	1,15	1,15	2,01	2,01	4,08	10,40	3,40	-14,50	4,60	A	4,68	4,68	2,26	0,64	-3,62	1130	10,60
20+20+35+42+42	1,13	1,13	1,98	2,38	2,38	9,00	2,90	-11,50	4,19	A	8,50	4,68	2,15	0,52	-3,35	1075	10,30	1,31	1,31	2,28	2,75	2,75	10,40	3,40	-14,50	4,79	A	4,68	4,68	2,17	0,54	-3,62	1085	10,20
20+20+35+42+50	1,08	1,08	1,89	2,26	2,69	9,00	2,90	-11,50	4,13	A	8,50	4,68	2,18	0,58	-3,29	1090	10,40	1,25	1,25	2,18	2,62	3,10	10,40	3,40	-14,50	4,60	A	4,68	4,68	2,26	0,63	-3,62	1130	10,60
20+20+35+42+60	1,02	1,02	1,78	2,14	3,04	9,00	2,90	-11,50	4,13	A	8,50	4,68	2,18	0,58	-3,29	1090	10,40	1,18	1,18	2,06	2,47	3,51	10,40	3,40	-14,50	4,60	A	4,68	4,68	2,26	0,63	-3,62	1130	10,60
20+20+35+50+50	1,03	1,03	1,80	2,57	2,57	9,00	2,90	-11,50	3,96	A	8,50	4,68	2,27	0,67	-3,24	1135	10,90	1,19	1,19	2,08	2,97	2,97	10,40	3,40	-14,50	4,41	A	4,68	4,68	2,36	0,75	-3,64	1180	11,10
20+20+42+42+42	1,08	1,08	2,28	2,28	2,28	9,00	2,90	-11,50	4,19	A	8,50	4,68	2,15	0,52	-3,35	1075	10,30	1,25	1,25	2,63	2,63	2,63	10,39	3,40	-14,50	4,79	A	4,68	4,68	2,17	0,54	-3,61	1085	10,20
20+20+42+42+50	1,03	1,03	2,17	2,17	2,60	9,00	2,90	-11,50	4,13	A	8,50	4,68	2,18	0,58	-3,29	1090	10,40	1,20	1,20	2,51	2,51	2,98	10,40	3,40	-14,50	4,60	A	4,68	4,68	2,26	0,65	-3,61	1130	10,60
20+20+42+50+50	0,99	0,99	2,08	2,47	2,47	9,00	2,90	-11,50	3,96	A	8,50	4,68	2,27	0,67	-3,24	1135	10,90	1,14	1,14	2,48	2,86	2,86	10,40	3,40	-14,50	4,39	A	4,68	4,68	2,37	0,75	-3,69	1185	11,10
20+25+25+25+25	1,48	1,88	1,88	1,88	1,88	9,00	2,90	-11,50	4,09	A	8,50	4,68	2,20	0,48	-3,49	1100	10,50	1,72	2,17	2,17	2,17	2,17	10,40	3,40	-14,50	4,88	A	4,68	4,68	2,13	0,46	-3,67	1065	10,00
20+25+25+25+35	1,38	1,73	1,73	1,73	2,43	9,00	2,90	-11,50	4,07	A	8,50	4,68	2,21	0,48	-3,41	1105	10,60	1,60	2,00	2,00	2,00	2,80	10,40	3,40	-14,50	4,81	A	4,68	4,68	2,16	0,48	-3,64	1080	10,20
20+25+25+25+42	1,31	1,64	1,64	1,64	2,77	9,00	2,90	-11,50	4,07	A	8,50	4,68	2,21	0,49	-3,41	1105	10,60	1,52	1,90	1,90	3,18	3,18	10,40	3,40	-14,50	4,81	A	4,68	4,68	2,16	0,49	-3,63	1080	10,20
20+25+25+25+50	1,24	1,55	1,55	1,55	3,11	9,00	2,90	-11,50	4,15	A	8,50	4,68	2,17	0,54	-3,28	1085	10,40	1,43	1,79	1,79	1,79	3,60	10,40	3,40	-14,50	4,73	A	4,68	4,68	2,20	0,58	-3,63	1100	10,30
20+25+25+25+60	1,16	1,45	1,45	1,45	3,49	9,00	2,90	-11,50	4,15	A	8,50	4,68	2,17	0,54	-3,28	1085	10,40	1,34	1,68	1,68	1,68	4,02	10,40	3,40	-14,50	4,73	A	4,68	4,68	2,20	0,58	-3,63	1100	10,30
20+25+25+25+71	1,08	1,36	1,36	1,36	3,84	9,00	2,90	-11,50	4,15	A	8,50	4,68	2,17	0,57	-3,28	1085	10,40	1,25	1,57	1,57	1,57	4,44	10,40	3,40	-14,50	4,75	A	4,68	4,68	2,19	0,59	-3,61	1095	10,30
20+25+25+35+35	1,28	1,61	1,61	2,25	2,25	9,00	2,90	-11,50	4,07	A	8,50	4,68	2,21	0,49	-3,42	1105	10,60	1,48	1,86	1,86	2,60	2,60	10,40	3,40	-14,50	4,84	A	4,68	4,68	2,15	0,51	-3,61	1075	10,10
20+25+25+35+42	1,22	1,53	1,53	2,14	2,58	9,00	2,90	-11,50	4,07	A	8,50	4,68	2,21	0,49	-3,42	1105	10,60	1,41	1,77	1,77	2,48	2,97	10,40	3,40	-14,50	4,84	A	4,68	4,68	2,15	0,51	-3,60	1075	10,10
20+25+25+35+50	1,16	1,45	1,45	2,03	2,91	9,00	2,90	-11,50	4,15	A	8,50	4,68	2,21	0,57	-3,28	1085	10,40	1,34	1,68	2,35	3,35	3,35	10,40	3,40	-14,50	4,66	A	4,68	4,68	2,23	0,60	-3,60	1115	10,50
20+25+25+35+60	1,09	1,36	1,36	1,91	3,28	9,00	2,90	-11,50	4,15	A	8,50	4,68	2,17	0,57	-3,28	1085	10,40	1,26	1,58	1,58	2,21	3,77	10,40	3,40	-14,50	4,66	A	4,68	4,68	2,23	0,60	-3,60	1115	10,50
20+25+25+35+71	1,02	1,28	1,28	1,79	3,63	9,00	2,90	-11,50	4,13	A	8,50	4,68	2,18	0,58	-3,29	1090	10,40	1,18	1,48	1,48	2,07	4,19	10,40	3,40	-14,50	4,66	A	4,68	4,68	2,23	0,62	-3,59	1115	10,50
20+25+25+42+42	1,18	1,46	1,46	2,45	2,45	9,00	2,90	-11,50	4,07	A	8,50	4,68	2,21	0,49	-3,42	1105	10,60	1,34	1,69	1,69	2,84	2,84	10,40	3,40	-14,50	4,77	A	4,68	4,68	2,18	0,52	-3,59	1090	10,20
20+25+25+42+50	1,11	1,39	1,39	2,33	2,78	9,00	2,90	-11,50	4,15	A	8,50	4,68	2,17	0,57	-3,28	1085	10,40	1,28	1,60	1,60	2,70	3,22	10,40	3,40	-14,50	4,66	A	4,68	4,68	2,23	0,61	-3,59	1115	10,50
20+25+25+42+60	1,05	1,31	1,31	2,20	3,13	9,00	2,90	-11,50	4,15	A	8,50	4,68	2,17	0,57	-3,28	1085	10,40	1,21	1,51	1,51	2,54	3,63	10,40	3,40	-14,50	4,66	A	4,68	4,68	2,23	0,61	-3,59	1115	10,50
20+25+25+42+71	0,98	1,23	1,23	2,07	3,49	9,00	2,90	-11,50	4,13	A	8,50	4,68	2,18	0,58	-3,29	1090	10,40	1,14	1,42	1,42	2,39	4,03	10,40	3,40	-14,50	4,66	A	4,68	4,68	2,23	0,63	-3,63	1115	10,50
20+25+25+50+50	1,06	1,32	1,32	2,65	2,65	9,00	2,90	-11,50	3,98	A	8,50	4,68	2,26	0,66	-3,23	1130	10,80	1,22	1,53	1,53	3,06	3,06	10,40	3,40	-14,50	4,46	A	4,68	4,68	2,33	0,72	-3,66	1165	10,90
20+25+25+50+60	1,00	1,25	1,25	2,50	3,00	9,00	2,90	-11,50	3,98	A	8,50	4,68	2,26	0,66	-3,23	1130	10,80	1,16	1,44	1,44	2,89	3,47	10,40	3,40	-14,50	4,46	A	4,68	4,68	2,33	0,72	-3,66	1165	10,90
20+25+35+35+35	1,20	1,50	2,10	2,10	2,10	9,00	2,90	-11,50	4,19	A	8,50	4,68	2,15	0,49	-3,34	1075	10,30	1,38	1,73	2,43	2,43	2,43	10,40	3,40	-14,50	4,77	A	4,68	4,68	2,18	0,52	-3,64	1090	10,20
20+25+35+35+42	1,15	1,43	2,01	2,01	2,40	9,00	2,90	-11,50	4,19	A	8,50	4,68	2,15	0,50	-3,34	1075	10,30	1,32	1,66	2,32	2,32	2,78	10,40	3,40	-14,50	4,77	A	4,68	4,68	2,18	0,53	-3,63	1090	10,20
20+25+35+35+50	1,09	1,36	1,91	1,91	2,73	9,00	2,90	-11,50	4,13	A	8,50	4,68	2,18	0,58	-3,29	1090	10,40	1,26	1,58	2,21	2,21	3,14	10,40	3,40	-14,50	4,66	A	4,68	4,68	2,23	0,63	-3,63	1115	10,50
20+25+35+35+60	1,03	1,29	1,80	1,80	3,08	9,00	2,90	-11,50	4,13	A	8,50	4,68	2,18	0,58	-3,29	1090	10,40	1,19	1,49	2,08	2,08	3,56	10,40	3,40	-14,50	4,66	A	4,68	4,68	2,23	0,63	-3,63	1115	10,50
20+25+35+42+42	1,10	1,37	1,93	2,30	2,30	9,00	2,90	-11,50	4,19	A	8,50	4,68	2,15	0,52	-3,35	1075	10,30	1,27	1,59	2,22	2,66	2,66	10,40	3,40	-14,50	4,79	A	4,68	4,68	2,17	0,54	-3,62	1085	10,20
20+25+35+42+50	1,05	1,31	1,83	2,20	2,61	9,00	2,90	-11,50	4,13	A	8,50	4,68	2,18	0,58	-3,29	1090	10,40	1,21	1,51	2,12	2,54	3,02	10,40	3,40	-14,50	4,60	A	4,68	4,68	2,26	0,63	-3,62	1130	10,60
20+25+35+42+60	0,99	1,24	1,73	2,08	2,96	9,00	2,90	-11,50	4,13	A	8,50	4,68	2,18	0,58	-3,29	1090	10,40	1,14	1,43	2,00	2,40	3,43	10,40	3,40	-14,50	4,60	A	4,68	4,68	2,26	0,63	-3,62	1130	10,60
20+25+35+50+50	1,00	1,25	1,75	2,50	2,50	9,00	2,90	-11,50	3,96	A	8,50	4,68	2,2																					

PACi: COMMERCIAL AIR TO AIR SOLUTIONS



Product quality and safety. All Panasonic air conditioners undergo strict quality and safety tests before sale. This rigorous process includes obtaining all necessary safety approvals, to ensure that all air conditioners we sell are not only built to the highest market standards, but are also completely safe.

PACi Elite: Newly designed next generation of commercial air conditioning

Outstanding performance at low temperatures, high energy efficiency, power consumption in remote control display. The energy saving design structure of fans, fan motors, compressors and heat exchangers resulted in high COP value which ranked as one the top class in the industry. Additional benefits include reduced CO₂ emissions, energy consumption and operating costs.

PACi Elite. From 3,60 to 25,00 kW.

- Meeting all necessary safety approvals to ensure quality and safety
- Top-class SEER: A++ / SCOP: A+++ at 3,60kW (in 90x90 Cassette)
- Cooling operation is possible when outdoor temperature as high as 46°C
- DC inverter technology combined with R32 and R410A
- Cooling operation is possible when outdoor temperature is as low as -15°C
- Heating operation is possible when outdoor temperature is as low as -20°C
- Compact outdoor units
- Auto restart from outdoor unit
- Twin, Triple and Double-Twin connection possible

PACi Standard: For economy and value

With high quality design and engineering, the PACi Standard is the perfect solution for projects which demand quality on a limited budget. In addition, its compact and lightweight design makes it ideal for installations with limited space including small commercial and residential applications.

The outdoor unit is much more compact than the previous model. The slim and lightweight design means the PACi outdoor unit can be installed in a number of situations.

PACi Standard. From 6,00 to 14,00 kW.

- Good balance, system cost vs energy efficiency
- Top class SEER/SCOP as a Standard Inverter category
SEER: A++ / SCOP: A++ at 6,00 and 7,10 kW (in 90x90 Cassette)
- Interchangeable controller with ECOi
- Compact outdoor units
- Twin connection possible
- Cooling operation up to -10°C
- Heating operation up to -15°C



New PACi R32 Refrigerant Gas

Panasonic recommends R32 because it is comparably environmentally friendly. Compared to R22 and R410A, R32 has a very low potential impact on the depletion of ozone layer and global warming.

In line with the European Countries who are concerned in protecting and maintaining the environment by participating in the Montreal Protocol to protect the Ozone Layer and prevent Global Warming, Panasonic is leading the switch to R32.

1. Installation innovation.

- Extremely easy to install, practically the same as R410A.

(Just remember to verify that the pressure gauge and vacuum pump are compatible with R32)

- This refrigerant is 100% pure, which makes it easier to recycle and reuse

2. Environmental innovation.

- Zero impact on the ozone layer
- 75% less impact on global warming vs R410A

3. Economic and energy consumption innovation.

- Lower cost and greater savings
- Higher energy efficiency than R410A

Big PACi Elite R410A. Trusted power and high efficiency











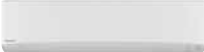
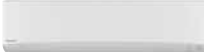
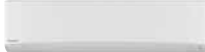
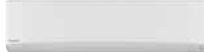
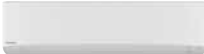
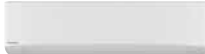
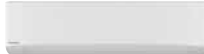
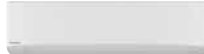

















PACi 20,00 and 25,00 kW are designed to adapt the most current and demanding commercial needs. Ready to connect to 1 big ducted indoor unit or up to 4 indoor units.

Large capacity PACi Elite.

- High efficiency
- Better partial load (10% ~ 100%)
- More flexible piping
- Bluefin anti-rust coating
- 0-10V control demand
- Energy saving functions
- AHU connection kit
- From 1 to 4 indoor units



RANGE OF COMMERCIAL UNITS R32

Page	Indoor units	2,50 kW	3,50 ~ 3,60 kW	4,50 kW	5,00 kW	6,00 kW
P. 96	NEW Wall Mounted Professional Inverter -20 °C • R32 GAS					
		KIT-E25-TKEA	KIT-E35-TKEA	KIT-E42-TKEA	KIT-E50-TKEA	
P. 100	NEW Wall Inverter+ • R32 GAS					
			S-36PK2E5B	S-45PK2E5B	S-50PK2E5B	S-60PK2E5B
P. 98	NEW 4 Way 60x60 Cassette Inverter • R32 GAS					
		KIT-Z25-UB4	KIT-Z35-UB4	KIT-Z50-UB4	KIT-Z60-UB4	
P. 104	NEW 4 Way 60x60 Cassette Inverter+ • R32 GAS					
			S-36PY2E5B	S-45PY2E5B	S-50PY2E5B	
P. 106	NEW 4 Way 90x90 Cassette Inverter+ • R32 GAS					
			S-36PU2E5B	S-45PU2E5B	S-50PU2E5B	S-60PU2E5B
P. 110	NEW Ceiling Inverter+ • R32 GAS					
			S-36PT2E5B	S-45PT2E5B	S-50PT2E5B	S-60PT2E5B
P. 99	NEW Low Static Pressure Hide Away Inverter • R32 GAS					
		KIT-Z25-UD3	KIT-Z35-UD3	KIT-Z50-UD3	KIT-Z60-UD3	
P. 114	NEW High Static Pressure Hide Away Inverter+ • R32 GAS					
			S-36PF1E5B	S-45PF1E5B	S-50PF1E5B	S-60PF1E5B
P. 118	NEW Low Static Pressure Hide Away Inverter+ • R32 GAS					
			S-36PN1E5B	S-45PN1E5B	S-50PN1E5B	S-60PN1E5B
P. 122	High Static Pressure Hide Away 20-25 kW Inverter+ • R410A GAS					

Outdoor units PACi Elite and Standard	3,60 kW	5,00 kW	6,00 kW
NEW PACi Elite • R32 GAS			
	U-36PZH2E5*	U-50PZH2E5*	U-60PZH2E5*
NEW PACi Standard • R32 GAS			
			U-60PZ2E5*

* These models will be available in Winter 2018. U- . .E5 Single Phase / U- . .E8 Three Phase.

Kits 1x1

R32

7,10 kW

10,00 kW

12,50 kW

14,00 kW

20,00 kW

25,00 kW



KIT-E71-TKEA

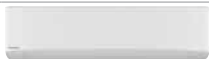

S-71PK2E5B

S-100PK2E5B (9,00 kW)



S-71PU2E5B



S-100PU2E5B



S-125PU2E5B



S-140PU2E5B



S-71PT2E5B



S-100PT2E5B



S-125PT2E5B



S-140PT2E5B



S-71PF1E5B



S-100PF1E5B



S-125PF1E5B



S-140PF1E5B



S-71PN1E5B



S-100PN1E5B



S-125PN1E5B



S-140PN1E5B



S-200PE2E5



S-250PE2E5

7,10 kW

10,00 kW

12,50 kW

14,00 kW

20,00 kW

25,00 kW



U-71PZH2E5*/U-71PZH2E8*



U-100PZH2E5*/U-100PZH2E8*



U-125PZH2E5*/U-125PZH2E8*



U-140PZH2E5*/U-140PZH2E8*



U-200PE2E8A



U-250PE2E8A



U-71PZ2E5*



U-100PZ2E5/U-100PZ2E8



U-125PZ2E5/U-125PZ2E8



U-140PZ2E5/U-140PZ2E8

SOLUTIONS FOR SERVER ROOMS



High efficiency products for 24/7 applications. Panasonic has developed a complete range of solutions for server rooms which efficiently protect your servers, keeping them at an appropriate temperature even when the outdoor temperature is below -20 °C.

High efficiency all the year

Key points:

- **NEW!** From 2,50 to 7,100 kW with new TKEA R32 gas units A+++ in cooling
- Backup function
- Redundancy function
- Alternative run function
- Error information by dry contact
- Operation even at -20 °C outdoor temperature
- High seasonal performance
- Product design for 24/7 operation

Splits 1x1

R32



NEW Wall Mounted Professional Inverter -20 °C • R32 GAS

KIT			KIT-Z25-TKEA	KIT-Z35-TKEA	KIT-Z42-TKEA	KIT-Z50-TKEA	KIT-Z71-TKEA
Cooling capacity	Nominal (Min - Max)	kW	2,50 (0,85 - 3,00)	3,50 (0,85 - 4,00)	4,20 (0,98 - 5,00)	5,00 (0,98 - 6,00)	7,10 (0,98 - 8,10)
EER ¹⁾	Nominal (Min - Max)	W/W	4,90 (5,00 - 4,29) A	4,07 (5,00 - 3,64) A	3,82 (4,90 - 3,25) A	3,60 (3,50 - 3,09) A	3,17 (2,33 - 3,03) B
SEER ²⁾	W/W		8,50 A+++	8,50 A+++	8,50 A+++	8,50 A+++	6,10 A++
Pdesign		kW	2,50	3,50	4,20	5,00	7,10
Input power cooling	Nominal (Min - Max)	kW	0,51 (0,17 - 0,70)	0,86 (0,17 - 1,10)	1,10 (0,20 - 1,54)	1,39 (0,28 - 1,94)	2,24 (0,42 - 2,67)
Annual energy consumption ³⁾		kWh/a	103	144	173	206	407
Heating capacity	Nominal (Min - Max)	kW	3,40 (0,85 - 5,40)	4,00 (0,85 - 6,60)	5,40 (0,98 - 7,25)	5,80 (0,98 - 8,00)	8,60 (0,98 - 9,90)
Heating capacity at -7 °C		kW	3,33	4,07	4,30	5,00	6,13
COP ¹⁾	Nominal (Min - Max)	W/W	4,86 (5,15 - 4,12) A	4,35 (5,15 - 3,63) A	4,00 (4,45 - 3,37) A	4,03 (2,88 - 3,20) A	3,51 (2,45 - 3,47) B
SCOP ²⁾	W/W		4,50 A+	4,40 A+	4,30 A+	4,40 A+	4,00 A+
Pdesign at -10 °C		kW	2,80	3,60	3,80	4,40	5,50
Input power heating	Nominal (Min - Max)	kW	0,70 (0,17 - 1,31)	0,92 (0,17 - 1,82)	1,35 (0,22 - 2,15)	1,44 (0,34 - 2,50)	2,45 (0,40 - 2,85)
Annual energy consumption ³⁾		kWh/a	871	1145	1237	1400	1925
Indoor unit			CS-Z25TKEA	CS-Z35TKEA	CS-Z42TKEA	CS-Z50TKEA	CS-Z71TKEA
Power source		V	230	230	230	230	230
Recommended fuse		A	16	16	16	16	20
Connection indoor / outdoor		mm ²	4 x 1,5	4 x 1,5	4 x 1,5	4 x 2,5	4 x 2,5
Air Volume	Cool / Heat	m ³ /min	10,40/11,70	10,70/12,40	18,20/20,20	19,20/21,30	20,20/21,00
Moisture removal volume		L/h	1,5	2,0	2,4	2,8	4,1
Sound pressure ⁴⁾	Cool (Hi / Lo / Q-Lo)	dB(A)	39/25/21	42/28/21	43/32/29	44/37/30	47/38/35
	Heat (Hi / Lo / Q-Lo)	dB(A)	41/27/22	43/30/22	44/35/29	44/37/30	47/38/35
Dimension	HxWxD	mm	295 x 919 x 194	295 x 919 x 194	302 x 1120 x 236	302 x 1120 x 236	302 x 1120 x 236
Net weight		kg	9	10	12	12	13
Outdoor unit			CU-Z25TKEA	CU-Z35TKEA	CU-Z42TKEA	CU-Z50TKEA	CU-Z71TKEA
Sound pressure ⁴⁾	Cool / Heat (Hi)	dB(A)	46/48	48/50	48/50	48/50	52/54
Dimension ⁵⁾	HxWxD	mm	619 x 824 x 299	619 x 824 x 299	619 x 824 x 299	695 x 875 x 320	695 x 875 x 320
Net weight		kg	37	38	38	43	49
Piping connections	Liquid pipe	Inch (mm)	1/4 (6,35)	1/4 (6,35)	1/4 (6,35)	1/4 (6,35)	1/4 (6,35)
	Gas pipe	Inch (mm)	3/8 (9,52)	3/8 (9,52)	1/2 (12,70)	1/2 (12,70)	5/8 (15,88)
Pipe length range		m	3-20	3-20	3-20	3-30	3-30
Elevation difference (in/out) ⁶⁾		m	15	15	15	15	20
Pipe length for additional gas		m	7,5	7,5	7,5	7,5	10
Additional gas amount		g/m	10	10	10	15	25
Refrigerant (R32)		kg/TCO ₂ Eq.	0,96 / 0,648	1,00 / 0,675	1,08 / 0,729	1,15 / 0,776	1,32 / 0,891
Operating range	Cool Min ~ Max	°C	-20 ~ +43	-20 ~ +43	-20 ~ +43	-20 ~ +43	-20 ~ +43
	Heat Min ~ Max	°C	-15 ~ +24	-15 ~ +24	-15 ~ +24	-15 ~ +24	-15 ~ +24

Accessories

CZ-TACG1	NEW Panasonic WLAN kit for internet control
CZ-CAPRA1	RAC interface adapter for integration into P Link
PAW-WTRAY	Tray for condenser water compatible with base ground support

Accessories

PAW-GRDSTD40	Outdoor elevation platform
PAW-GRDBSE20	Outdoor base ground support for noise and vibration absorption
PAW-SERVER-PKEA	PCB for installation in server rooms with security

1) EER and COP calculation is based in accordance to EN14511. 2) Energy Label Scale from A+++ to D. 3) The annual energy consumption is calculated in accordance to EU/626/2011. 4) The sound pressure of the units shows the value measured of a position 1 m in front of the main body and 0,8 m below the unit. The sound pressure is measured in accordance with Eurovent 6/C/006-97 specification. Q-Lo: Quiet mode. Lo: The lowest fan speed. 5) Add 70 mm for piping port. 6) When installing the outdoor unit at a higher position than the indoor unit.



SEER and SCOP: For KIT-Z25-TKEA. SUPER QUIET: For KIT-Z25-TKEA. INTERNET CONTROL: Optional.

R32

Splits 1x1



NEW CZ-BT20EW RAL9010 panel for 4 Way 60x60 Cassette

CZ-TACG1
Panasonic WLAN kit
for internet control.



NEW 4 Way 60x60 Cassette Inverter • R32 GAS

Kit			KIT-Z25-UB4	KIT-Z35-UB4	KIT-Z50-UB4	KIT-Z60-UB4
Cooling capacity	Nominal (Min - Max)	kW	2,50 (0,85 - 3,20)	3,50 (0,85 - 4,00)	5,00 (0,90 - 5,80)	6,00 (0,90 - 6,35)
EER ¹⁾	Nominal (Min - Max)	W/W	4,55 (3,54 - 3,90) A	3,89 (3,54 - 3,39) A	3,25 (3,53 - 3,09) A	2,93 (3,53 - 2,89) C
SEER ²⁾	W/W	6,30 A++	6,50 A++	6,40 A++	6,20 A++	
Pdesign (cooling)		kW	2,50	3,50	5,00	6,00
Input power cooling	Nominal (Min - Max)	kW	0,55 (0,24 - 0,82)	0,90 (0,24 - 1,18)	1,54 (0,26 - 1,88)	2,05 (0,26 - 2,20)
Annual energy consumption ³⁾		kWh/a	139	188	273	339
Heating capacity	Nominal (Min - Max)	kW	3,20 (0,85 - 4,80)	4,50 (0,85 - 5,60)	5,60 (0,90 - 7,10)	7,00 (0,90 - 8,00)
Heating capacity at -7 °C		kW	2,88	3,37	4,40	5,10
COP ¹⁾	Nominal (Min - Max)	W/W	4,05 (3,70 - 3,64) A	3,31 (3,70 - 3,20) C	3,03 (3,46 - 2,95) D	2,92 (3,46 - 2,91) D
SCOP ²⁾	W/W	4,30 A+	4,20 A+	4,30 A+	4,20 A+	
Pdesign at -10 °C		kW	2,70	3,00	3,80	4,00
Input power heating	Nominal (Min - Max)	kW	0,79 (0,23 - 1,32)	1,36 (0,23 - 1,75)	1,85 (0,26 - 2,41)	2,40 (0,26 - 2,75)
Annual energy consumption ³⁾		kWh/a	879	1000	1237	1333
Indoor unit			CS-Z25UB4EAW	CS-Z35UB4EAW	CS-Z50UB4EAW	CS-Z60UB4EAW
Panel			CZ-BT20EW	CZ-BT20EW	CZ-BT20EW	CZ-BT20EW
Air volume	Cool / Heat	m³/min	10,5/10,8	10,5/10,8	11,5/11,8	12,4/13,5
Moisture removal volume		L/h	1,5	2,0	2,8	3,3
Sound pressure ⁴⁾	Cool (Hi / Lo / Q-Lo)	dB(A)	34/25/22	34/26/23	37/28/25	42/32/29
	Heat (Hi / Lo / Q-Lo)	dB(A)	35/28/25	35/28/25	38/29/26	43/32/29
Dimension (HxWxD)	Indoor	mm	260x575x575	260x575x575	260x575x575	260x575x575
	Panel	mm	51x700x700	51x700x700	51x700x700	51x700x700
Net weight	Indoor / Panel	kg	18/2,5	18/2,5	18/2,5	18/2,5
Outdoor unit			CU-Z25UBEA	CU-Z35UBEA	CU-Z50UBEA	CU-Z60UBEA
Power source		V	230	230	230	230
Recommended fuse		A	—	—	—	—
Connection indoor / outdoor		mm²	—	—	—	—
Air volume	Cool / Heat	m³/min	28,7/27,2	34,3/33,5	39,7/38,6	42,6/41,5
Sound pressure ⁴⁾	Cool / Heat (Hi)	dB(A)	46/47	48/48	48/48	49/50
Dimension ⁵⁾	HxWxD	mm	542x780x289	619x824x299	695x875x320	695x875x320
Net weight		kg	33	35	43	43
Piping connections	Liquid pipe	Inch (mm)	1/4 (6,35)	1/4 (6,35)	1/4 (6,35)	1/4 (6,35)
	Gas pipe	Inch (mm)	3/8 (9,52)	3/8 (9,52)	1/2 (12,70)	1/2 (12,70)
Pipe length range		m	3~20	3~20	3~30	3~30
Elevation difference (in/out) ⁶⁾		m	15	15	20	20
Pipe length for additional gas		m	7,5	7,5	7,5	7,5
Additional gas amount		g/m	10	10	15	15
Refrigerant (R32)		kg/TCO ₂ Eq.	0,88/0,594	0,93/0,628	1,13/0,763	1,13/0,763
Operating range	Cool Min ~ Max	°C	-10~+43	-10~+43	-10~+43	-10~+43
	Heat Min ~ Max	°C	-15~+24	-15~+24	-15~+24	-15~+24

Accessories

- CZ-TACG1** NEW Panasonic WLAN kit for internet control
- CZ-CAPRA1** RAC interface adapter for integration into P Link

Accessories

- CZ-RD52CP** Wired remote controller for Cassette

1) EER and COP calculation is based in accordance to EN14511. 2) Energy Label Scale from A+++ to D. 3) The annual energy consumption is calculated in accordance to EU/626/2011. 4) The sound pressure of the units shows the value measured of a position 1,5 m below the unit. The sound pressure is measured in accordance with Eurovent 6/C/006-97 specification. Q-Lo: Quiet mode. Lo: The lowest fan speed. 5) Add 70 mm for piping port. 6) When installing the outdoor unit at a higher position than the indoor unit.



SEER and SCOP: For KIT-Z35-UB4EA. SUPER QUIET: For KIT-Z25-UB4EA. INTERNET CONTROL: Optional.

Splits 1x1

R32



CZ-TACG1
Panasonic WLAN kit for internet control.

NEW Low Static Pressure Hide Away Inverter • R32 GAS

Kit			KIT-Z25-UD3	KIT-Z35-UD3	KIT-Z50-UD3	KIT-Z60-UD3
Cooling capacity	Nominal (Min - Max)	kW	2,50 (0,85 - 3,20)	3,50 (0,85 - 4,00)	5,10 (0,90 - 5,70)	6,00 (0,90 - 6,50)
EER ¹⁾	Nominal (Min - Max)	W/W	4,31 (3,54 - 3,76) A	3,85 (3,54 - 3,36) A	3,27 (3,53 - 3,20) A	2,94 (3,53 - 2,83) C
SEER ²⁾	W/W	5,90 A+	5,80 A+	5,90 A+	5,60 A+	
Pdesign (cooling)		kW	2,50	3,50	5,10	6,00
Input power cooling	Nominal (Min - Max)	kW	0,58 (0,24 - 0,85)	0,91 (0,24 - 1,19)	1,56 (0,26 - 1,78)	2,04 (0,26 - 2,30)
Annual energy consumption ³⁾		kWh/a	148	211	303	375
Heating capacity	Nominal (Min - Max)	kW	3,20 (0,85 - 4,60)	4,20 (0,85 - 5,10)	6,10 (0,90 - 7,20)	7,00 (0,90 - 8,00)
Heating capacity at -7 °C		kW	2,60	3,00	4,50	5,10
COP ¹⁾	Nominal (Min - Max)	W/W	4,00 (3,70 - 3,68) A	3,82 (3,70 - 3,59) A	3,35 (3,46 - 3,27) C	3,24 (3,46 - 3,08) C
SCOP ²⁾	W/W	4,20 A+	4,10 A+	4,10 A+	4,10 A+	
Pdesign at -10 °C		kW	2,60	2,80	4,00	4,60
Input power heating	Nominal (Min - Max)	kW	0,80 (0,23 - 1,25)	1,10 (0,23 - 1,42)	1,82 (0,26 - 2,20)	2,16 (0,26 - 2,60)
Annual energy consumption ³⁾		kWh/a	867	956	1366	1571
Indoor unit			CS-Z25UD3EAW	CS-Z35UD3EAW	CS-Z50UD3EAW	CS-Z60UD3EAW
External static pressure ⁴⁾	Min - Max	Pa	15 - 45	15 - 45	15 - 50	15 - 50
Air volume	Cool / Heat	m³/min	10,5/10,5	11,2/11,2	15,3/15,3	15,7/15,7
Moisture removal volume		L/h	1,5	2,0	2,8	3,3
Sound pressure ⁵⁾	Cool (Hi / Lo / Q-Lo)	dB(A)	33/27/24	33/27/24	39/29/26	41/30/27
	Heat (Hi / Lo / Q-Lo)	dB(A)	35/27/24	35/27/24	39/30/27	41/32/29
Dimension	HxWxD	mm	200 x 750 x 640	200 x 750 x 640	200 x 750 x 640	200 x 750 x 640
Net weight		kg	19	19	19	19
Outdoor unit			CU-Z25UBEA	CU-Z35UBEA	CU-Z50UBEA	CU-Z60UBEA
Power source		V	230	230	230	230
Recommended fuse		A	16	16	16	—
Connection indoor / outdoor		mm²	4 x 1,5 to 2,5	4 x 1,5 to 2,5	4 x 1,5 to 2,5	—
Air volume	Cool / Heat	m³/min	28,7/27,2	34,3/33,5	39,7/38,6	42,6/41,5
Sound pressure ⁵⁾	Cool / Heat (Hi)	dB(A)	46/47	48/48	48/48	49/50
Dimension ⁶⁾	HxWxD	mm	542 x 780 x 289	619 x 824 x 299	695 x 875 x 320	695 x 875 x 320
Net weight		kg	33	35	43	43
Piping connections	Liquid pipe	Inch (mm)	1/4 (6,35)	1/4 (6,35)	1/4 (6,35)	1/4 (6,35)
	Gas pipe	Inch (mm)	3/8 (9,52)	3/8 (9,52)	1/2 (12,70)	1/2 (12,70)
Pipe length range		m	3 - 20	3 - 20	3 - 30	3 - 30
Elevation difference (in/out) ⁷⁾		m	15	15	20	20
Pipe length for additional gas		m	7,5	7,5	7,5	7,5
Additional gas amount		g/m	10	10	15	15
Refrigerant (R32)		kg/TCO ₂ Eq.	0,88/0,594	0,93/0,628	1,13/0,763	1,13/0,763
Operating range	Cool Min ~ Max	°C	-10 ~ +43	-10 ~ +43	-10 ~ +43	-10 ~ +43
	Heat Min ~ Max	°C	-15 ~ +24	-15 ~ +24	-15 ~ +24	-15 ~ +24

Accessories

CZ-TACG1 **NEW** Panasonic WLAN kit for internet control

Accessories

CZ-CAPRA1 RAC interface adapter for integration into P Link

1) EER and COP calculation is based in accordance to EN14511. 2) Energy Label Scale from A+++ to D. 3) The annual energy consumption is calculated in accordance to EU/626/2011. 4) The specification listed on the table indicates values under the condition of 25 Pa (2,5 mmAq) which are applied for factory default setting. Change switch on PCB from Hi to Shi to have more than 6,0 mmAq. 5) The sound pressure of the units shows the value measured of a position of 1,5 m below the unit with 1 m duct on the suction side and 2 m duct on the discharge side. The sound pressure is measured in accordance with Eurovent 6/C/006-97 specification. 6) Add 100 mm for indoor unit or 70 mm for outdoor unit for piping port. 7) When installing the outdoor unit at a higher position than the indoor unit.



SEER and SCOP: For KIT-Z25-UD3EA. INTERNET CONTROL: Optional.

R32

Kits 1x1



NEW PACi Elite Wall Mounted Inverter+ • R32 GAS

Tentative data

			Single Phase				
			3,60 kW	5,00 kW	6,00 kW	7,10 kW	9,00 kW
Kit			KIT-36PK2ZH5	KIT-50PK2ZH5	KIT-60PK2ZH5	KIT-71PK2ZH5	KIT-100PK2ZH5
Remote controller			CZ-RTC5B	CZ-RTC5B	CZ-RTC5B	CZ-RTC5B	CZ-RTC5B
Cooling capacity	Nominal (Min - Max)	kW	3,60 (1,50 ~ 4,00)	5,00 (1,50 ~ 5,60)	6,10 (2,00 ~ 7,10)	7,10 (2,50 ~ 8,00)	9,50 (3,30 ~ 10,50)
EER ¹⁾		W/W	4,86	3,91	3,72	3,46	3,32
SEER ²⁾		W/W	6,60 A++	6,60 A++	6,70 A++	6,70 A++	6,30 A++
Pdesign		kW	3,60	5,00	6,10	7,10	9,50
Input power cooling		kW	0,74	1,28	1,64	2,05	2,86
Annual energy consumption ³⁾		kWh/a	—	—	—	—	—
Heating capacity	Nominal (Min - Max)	kW	4,00 (1,50 ~ 5,00)	5,60 (1,50 ~ 6,50)	7,00 (1,80 ~ 8,00)	8,00 (2,00 ~ 9,00)	9,50 (4,10 ~ 11,50)
Heating capacity at -7°C / -15°C ⁴⁾		kW	—	—	—	—	—
COP ¹⁾		W/W	4,94	4,12	4,24	4,00	3,97
SCOP ²⁾		W/W	4,50 A+	4,30 A+	4,40 A+	4,30 A+	4,00 A+
Pdesign at -10°C		kW	3,60	4,50	6,00	5,20	8,00
Input power heating		kW	0,81	1,36	1,65	2,00	2,39
Annual energy consumption ³⁾		kWh/a	—	—	—	—	—
Indoor unit			S-36PK2E5B	S-50PK2E5B	S-60PK2E5B	S-71PK2E5B	S-100PK2E5B
Air volume	Hi / Med / Lo	m ³ /min	13/11/09	16/14/11	20/18/15	20/18/15	22/19/15
Sound pressure ⁵⁾	Hi / Med / Lo	dB(A)	35/31/27	40/36/32	47/44/40	47/44/40	49/45/41
Dimension	H x W x D	mm	302 x 1120 x 236	302 x 1120 x 236	302 x 1120 x 236	302 x 1120 x 236	302 x 1120 x 236
Net weight		kg	13	13	14	14	14
Outdoor unit			U-36PZH2E5	U-50PZH2E5	U-60PZH2E5	U-71PZH2E5	U-100PZH2E5
Power source		V	220/230/240	220/230/240	220/230/240	220/230/240	220/230/240
Sound pressure	Cool / Heat (Hi)	dB(A)	45/46	46/48	46/49	48/50	52/52
Sound power	Cool / Heat (Hi)	dB	64/66	65/68	65/69	65/67	69/69
Dimension	H x W x D	mm	695 x 875 x 320	695 x 875 x 320	695 x 875 x 320	996 x 940 x 340	1416 x 940 x 340
Net weight		kg	49	49	49	68	101
Piping connections	Liquid pipe	Inch (mm)	1/4 (6,35)	1/4 (6,35)	3/8 (9,52)	3/8 (9,52)	3/8 (9,52)
	Gas pipe	Inch (mm)	1/2 (12,70)	1/2 (12,70)	5/8 (15,88)	5/8 (15,88)	5/8 (15,88)
Pipe length range		m	3 ~ 40	3 ~ 40	3 ~ 40	5 ~ 50	5 ~ 75
Elevation difference (in/out) ⁶⁾		m	30	30	30	30	30
Pipe length for additional gas		m	30	30	30	30	30
Additional gas amount		g/m	—	—	—	—	—
Refrigerant (R32)		kg/TCO ₂ Eq.	—	—	—	—	—
Operating range	Cool Min ~ Max	°C	-15 ~ +46	-15 ~ +46	-15 ~ +46	-15 ~ +46	-15 ~ +46
	Heat Min ~ Max	°C	-20 ~ +24	-20 ~ +24	-20 ~ +24	-20 ~ +24	-20 ~ +24

Accessories

CZ-RTC5B	Wired remote controller with Econavi button and datanavi
CZ-RWS3	Wireless remote controller
CZ-RE2C2	Simplified remote controller
PAW-GRDSTD40	Outdoor elevation platform 400 x 900 x 400mm
PAW-WTRAY	Tray for condenser water compatible with base ground support

Accessories

PAW-GRDBSE20	Outdoor base ground support for noise and vibration absorption
PAW-WPH7	Wind protection shield for U-100/125/140PZH2E5/8
PAW-WPH9	Wind protection shield for U-71PZH2E5/8
PAW-PACR3	Interfaces to run 3 units on Backup and alternative run



NEW PACi Elite Wall Mounted Inverter+ • R32 GAS

Tentative data

			Three Phase	
			7,10 kW	9,00 kW
Kit			KIT-71PK2ZH8	KIT-100PK2ZH8
Remote controller			CZ-RTC5B	CZ-RTC5B
Cooling capacity	Nominal (Min - Max)	kW	7,10 (3,20 - 8,00)	9,50 (3,30 - 10,50)
EER ¹⁾		W/W	3,46	3,32
SEER ²⁾		W/W	6,60 A++	6,20 A++
Pdesign		kW	7,10	9,50
Input power cooling		kW	2,05	2,86
Annual energy consumption ³⁾		kWh/a	—	—
Heating capacity	Nominal (Min - Max)	kW	8,00 (2,80 - 9,00)	9,50 (4,10 - 11,50)
Heating capacity at -7°C / -15°C ⁴⁾		kW	—	—
COP ¹⁾		W/W	4,00	3,97
SCOP ²⁾		W/W	4,30 A+	4,00 A+
Pdesign at -10°C		kW	5,20	8,00
Input power heating		kW	2,00	2,39
Annual energy consumption ³⁾		kWh/a	—	—
Indoor unit			S-71PK2E5B	S-100PK2E5B
Air volume	Hi / Med / Lo	m ³ /min	20 / 18 / 15	22 / 19 / 15
Sound pressure ⁵⁾	Hi / Med / Lo	dB(A)	47 / 44 / 40	49 / 45 / 41
Dimension	H x W x D	mm	302 x 1120 x 236	302 x 1120 x 236
Net weight		kg	14	14
Outdoor unit			U-71PZH2E8	U-100PZH2E8
Power source		V	380 / 400 / 415	380 / 400 / 415
Sound pressure	Cool / Heat (Hi)	dB(A)	48 / 50	52 / 52
Sound power	Cool / Heat (Hi)	dB	65 / 67	69 / 69
Dimension	H x W x D	mm	996 x 940 x 340	1416 x 940 x 340
Net weight		kg	68	101
Piping connections	Liquid pipe	Inch (mm)	3/8 (9,52)	3/8 (9,52)
	Gas pipe	Inch (mm)	5/8 (15,88)	5/8 (15,88)
Pipe length range		m	5 - 50	5 - 75
Elevation difference (in/out) ⁶⁾		m	30	30
Pipe length for additional gas		m	30	30
Additional gas amount		g/m	—	—
Refrigerant (R32)		kg/TCO: Eq.	—	—
Operating range	Cool Min ~ Max	°C	-15 ~ +46	-15 ~ +46
	Heat Min ~ Max	°C	-20 ~ +24	-20 ~ +24

1) EER and COP calculation is based in accordance to EN14511. 2) For models below 12 kW, the SEER and SCOP is calculated based on values of EU/626/2011. For models above 12 kW, the SEER and SCOP is calculated based on values of EU/2281/2016. 3) The annual energy consumption is calculated in accordance to EU/626/2011. 4) Heating capacity is calculated including defrost factor correction. 5) The sound pressure of the units shows the value measured of a position 1m in front of the main body and 1,5 m from the ground. The sound pressure is measured in accordance with Eurovent 6/C/006-97 specification. 6) When installing the outdoor unit at a higher position than the indoor unit.* Recommended fuse for the indoor 3A.



SEER: For KIT-60PK2ZH5. SCOP: For KIT-36PK2ZH5. INTERNET CONTROL: Optional.
Compatible with all Panasonic connectivity solutions. For detailed information go to the Control Systems section.

Rating Conditions: Cooling Indoor 27 °C DB / 19 °C WB. Cooling Outdoor 35 °C DB / 24 °C WB. Heating Indoor 20 °C DB. Heating Outdoor 7 °C DB / 6 °C WB. (DB: Dry Bulb; WB: Wet Bulb)
Specifications subject to change without notice. For detailed information about ErP / Energy Labelling, please visit our websites www.aircon.panasonic.eu or www.ptc.panasonic.eu.

R32

Kits 1x1



NEW PACi Standard Wall Mounted Inverter+ • R32 GAS

Tentative data

			Single Phase		
			6,00 kW	7,10 kW	9,00 kW
Kit			KIT-60PK2Z5	KIT-71PK2Z5	KIT-100PK2Z5
Remote controller			CZ-RTC5B	CZ-RTC5B	CZ-RTC5B
Cooling capacity	Nominal (Min - Max)	kW	6,10 (2,00 - 7,10)	7,10 (2,00 - 7,70)	9,00 (3,00 - 9,70)
EER ¹⁾	Nominal (Min - Max)	W/W	3,61	3,01	3,47 (5,36 - 3,13)
SEER ²⁾	W/W		5,70 A+	5,40 A	6,50 A++
Pdesign		kW	6,10	7,10	9,00
Input power cooling	Nominal (Min - Max)	kW	1,69	2,36	2,59 (0,56 - 3,10)
Annual energy consumption ³⁾		kWh/a	—	—	485
Heating capacity	Nominal (Min - Max)	kW	6,10 (1,80 - 7,00)	7,10 (1,80 - 8,10)	9,00 (3,00 - 10,50)
Heating capacity at -7°C / -15°C ⁴⁾		kW	—	—	7,92 / —
COP ¹⁾	Nominal (Min - Max)	W/W	4,49	4,23	3,93 (5,36 - 3,56)
SCOP ²⁾	W/W		4,20 A+	4,10 A+	3,90 A
Pdesign at -10°C		kW	6,00	6,00	9,00
Input power heating	Nominal (Min - Max)	kW	1,36	1,68	2,29 (0,56 - 2,95)
Annual energy consumption ³⁾		kWh/a	—	—	3231
Indoor unit			S-60PK2E5B	S-71PK2E5B	S-100PK2E5B
Air volume	Hi / Med / Lo	m ³ /min	20,00/18,00/15,00	20,00/18,00/15,00	22,00/18,50/15,00
Moisture removal volume		L/h	2,0	3,0	4,3
Sound pressure ⁵⁾	Hi / Med / Lo	dB(A)	47/44/40	47/44/40	49/45/41
Sound power	Hi / Med / Lo	dB	63/60/56	63/60/56	65/61/57
Dimension	HxWxD	mm	302x1120x236	302x1120x236	302x1120x236
Net weight		kg	14	14	14
Outdoor unit			U-60PZ2E5	U-71PZ2E5	U-100PZ2E5
Power source		V	220/230/240	220/230/240	220/230/240
Current	Cool	A	—	—	12,10/11,50/11,10
	Heat	A	—	—	10,60/10,29/9,70
Air volume	Cool / Heat	m ³ /min	—	—	76/70
Sound pressure	Cool / Heat (Hi)	dB(A)	46/48	49/49	52/52
Sound power	Cool / Heat (Hi)	dB	65/68	69/69	70/70
Dimension	HxWxD	mm	695x875x320	695x875x320	996x980x370
Net weight		kg	49	49	90
Piping connections	Liquid pipe	Inch (mm)	3/8(9,52)	3/8(9,52)	3/8(9,52)
	Gas pipe	Inch (mm)	5/8(15,88)	5/8(15,88)	5/8(15,88)
Pipe length range		m	3~40	3~40	5~50
Elevation difference (in/out) ⁶⁾		m	30	30	30
Pipe length for additional gas		m	30	30	30
Additional gas amount		g/m	—	—	45
Refrigerant (R32)		kg/TCO ₂ Eq.	—	—	2,60/1,755
Operating range	Cool Min ~ Max	°C	-10 ~ +43	-10 ~ +43	-10 ~ +43
	Heat Min ~ Max	°C	-15 ~ +24	-15 ~ +24	-15 ~ +24

Accessories

CZ-RTC5B	Wired remote controller with Econavi button and datanavi
CZ-RWS3	Wireless remote controller
CZ-RE2C2	Simplified remote controller
PAW-GRDSTD40	Outdoor elevation platform 400x900x400mm

Accessories

PAW-WTRAY	Tray for condenser water compatible with base ground support
PAW-GRDBSE20	Outdoor base ground support for noise and vibration absorption
PAW-PACR3	Interfaces to run 3 units on Backup and alternative run

Kits 1x1

R32



Controller. Wired remote controller CZ-RTC5B
 Optional Controller. Wireless remote controller CZ-RWS3
 Optional Controller. Simplified remote controller CZ-RE2C2
 Optional Econovi Sensor. CZ-CENS1



NEW PACi Standard Wall Mounted Inverter+ • R32 GAS

Tentative data

			Three Phase
			9,00 kW
Kit			KIT-100PK2Z8
Remote controller			CZ-RTC5B
Cooling capacity	Nominal (Min - Max)	kW	9,00 (3,00 - 9,70)
EER ¹⁾	Nominal (Min - Max)	W/W	3,47 (5,36 - 3,13)
SEER ²⁾		W/W	6,50 A++
Pdesign		kW	9,00
Input power cooling	Nominal (Min - Max)	kW	2,59 (0,56 - 3,10)
Annual energy consumption ³⁾		kWh/a	485
Heating capacity	Nominal (Min - Max)	kW	9,00 (3,00 - 10,50)
Heating capacity at -7°C / -15°C ⁴⁾		kW	7,92 / —
COP ¹⁾	Nominal (Min - Max)	W/W	3,93 (5,36 - 3,56)
SCOP ²⁾		W/W	3,90 A
Pdesign at -10°C		kW	9,00
Input power heating	Nominal (Min - Max)	kW	2,29 (0,56 - 2,95)
Annual energy consumption ³⁾		kWh/a	3231
Indoor unit			S-100PK2E5B
Air volume	Hi / Med / Lo	m ³ /min	22,00 / 18,50 / 15,00
Moisture removal volume		L/h	4,3
Sound pressure ⁵⁾	Hi / Med / Lo	dB(A)	49 / 45 / 41
Sound power	Hi / Med / Lo	dB	65 / 61 / 57
Dimension	HxWxD	mm	302 x 1120 x 236
Net weight		kg	14
Outdoor unit			U-100PZ2E8
Power source		V	380 / 400 / 415
Current	Cool	A	4,10 / 3,90 / 3,15
	Heat	A	3,60 / 3,45 / 3,30
Air volume	Cool / Heat	m ³ /min	76 / 70
Sound pressure	Cool / Heat (Hi)	dB(A)	52 / 52
Sound power	Cool / Heat (Hi)	dB	70 / 70
Dimension	HxWxD	mm	996 x 980 x 370
Net weight		kg	90
Piping connections	Liquid pipe	Inch (mm)	3/8 (9,52)
	Gas pipe	Inch (mm)	5/8 (15,88)
Pipe length range		m	5 - 50
Elevation difference (in/out) ⁶⁾		m	30
Pipe length for additional gas		m	30
Additional gas amount		g/m	45
Refrigerant (R32)		kg / TCO: Eq.	2,60 / 1,755
Operating range	Cool Min ~ Max	°C	-10 ~ +43
	Heat Min ~ Max	°C	-15 ~ +24

1) EER and COP calculation is based in accordance to EN14511. 2) For models below 12 kW, the SEER and SCOP is calculated based on values of EU/626/2011. For models above 12 kW, the SEER and SCOP is calculated based on values of EU/2281/2016. 3) The annual energy consumption is calculated in accordance to EU/626/2011. 4) Heating capacity is calculated including defrost factor correction. 5) The sound pressure of the units shows the value measured of a position 1m in front of the main body and 1,5 m from the ground. The sound pressure is measured in accordance with Eurovent 6/C/006-97 specification. 6) When installing the outdoor unit at a higher position than the indoor unit. * Recommended fuse for the indoor 3A.



SEER: For KIT-100PK2Z5. SCOP: For KIT-60PK2Z5. INTERNET CONTROL: Optional.
 Compatible with all Panasonic connectivity solutions. For detailed information go to the Control Systems section.

Rating Conditions: Cooling Indoor 27 °C DB / 19 °C WB. Cooling Outdoor 35 °C DB / 24 °C WB. Heating Indoor 20 °C DB. Heating Outdoor 7 °C DB / 6 °C WB. (DB: Dry Bulb; WB: Wet Bulb)
 Specifications subject to change without notice. For detailed information about ErP / Energy Labelling, please visit our websites www.aircon.panasonic.eu or www.ptc.panasonic.eu.

R32

Kits 1x1



NEW 18



Controller. Wired remote controller CZ-RTCS5B



Optional Controller. Wireless remote controller CZ-RWS3



Optional Controller. Simplified remote controller CZ-RE2C2



Panel CZ-KPY3AW (size 700x700mm) CZ-KPY3BW (size 625x625mm)



NEW PACi Elite 4 Way 60x60 Cassette Inverter+ • R32 GAS

Tentative data

			Single Phase	
			3,60 kW	5,00 kW
Kit			KIT-36PY2ZH5	KIT-50PY2ZH5
Remote controller			CZ-RTCS5B	CZ-RTCS5B
Cooling capacity	kW		3,60	5,00
EER ¹⁾	W/W		4,74	3,70
SEER ²⁾	W/W		6,50 A++	6,40 A++
Pdesign	kW		3,60	5,00
Input power cooling	kW		0,76	1,35
Annual energy consumption ³⁾	kWh/a		—	—
Heating capacity	kW		4,00	5,60
Heating capacity at -7°C / -15°C ⁴⁾	kW		—	—
COP ¹⁾	W/W		4,21	3,41
SCOP ²⁾	W/W		4,30 A+	4,10 A+
Pdesign at -10°C	kW		3,60	4,50
Input power heating	kW		0,95	1,64
Annual energy consumption ³⁾	kWh/a		—	—
Indoor unit			S-36PY2E5B	S-50PY2E5B
Air volume	Hi / Med / Lo	m ³ /min	9,70/8,00/6,00	11,10/9,80/8,50
Moisture removal volume		L/h	1,5	2,4
Sound pressure ⁴⁾	Hi / Med / Lo	dB(A)	36/32/26	40/37/33
Sound power	Hi / Med / Lo	dB	51/47/41	55/52/48
Dimension (HxWxD) / Net weight	Indoor	mm / kg	288x583x583/18	288x583x583/18
	CZ-KPY3AW Panel	mm / kg	31x700x700/2,4	31x700x700/2,4
	CZ-KPY3BW Panel	mm / kg	31x625x625/2,4	31x625x625/2,4
Outdoor unit			U-36PZH2E5	U-50PZH2E5
Power source		V	220/230/240	220/230/240
Current	Cool	A	—	—
	Heat	A	—	—
Air volume	Cool / Heat	m ³ /min	—	—
Sound pressure	Cool / Heat (Hi)	dB(A)	45/46	46/48
Sound power	Cool / Heat (Hi)	dB	64/66	65/68
Dimension / Net weight	HxWxD	mm / kg	695x875x320/49	695x875x320/49
Piping connections	Liquid pipe	Inch (mm)	1/4(6,35)	1/4(6,35)
	Gas pipe	Inch (mm)	1/2(12,70)	1/2(12,70)
Pipe length range		m	30	30
Elevation difference (in/out) ⁶⁾		m	—	—
Pipe length for additional gas		m	30	30
Additional gas amount		g/m	—	—
Refrigerant (R32)		kg/TCO ₂ Eq.	—	—
Operating range	Cool Min ~ Max	°C	-15 ~ +46	-15 ~ +46
	Heat Min ~ Max	°C	-20 ~ +24	-20 ~ +24

Accessories

CZ-RTCS5B	Wired remote controller with Econavi button and datanavi
CZ-RWS3	Wireless remote controller
CZ-RE2C2	Simplified remote controller
PAW-WTRAY	Tray for condenser water compatible with base ground support

Accessories

PAW-GRDBSE20	Outdoor base ground support for noise and vibration absorption
PAW-GRDSTD40	Outdoor elevation platform 400x900x400mm



SEER and SCOP: For KIT-36PY2ZH5. INTERNET CONTROL: Optional.
Compatible with all Panasonic connectivity solutions. For detailed information go to the Control Systems section.

Kits 1x1

R32

NEW PACi Standard 4 Way 60x60 Cassette Inverter+ • R32 GAS

			3,60 kW	4,50 kW	5,00 kW
Indoor unit			S-36PY2E5B	S-45PY2E5B ¹⁾	S-50PY2E5B
Cooling capacity		kW	3,60	4,50	5,00
Heating capacity		kW	4,00	5,20	5,60
Current	Cool	A	0,30/0,30/0,30	0,32/0,32/0,32	0,35/0,35/0,35
	Heat	A	0,30/0,30/0,30	0,30/0,30/0,30	0,35/0,35/0,35
Input power	Cool	kW	0,04	0,04	0,05
	Heat	kW	0,04	0,04	0,04
Air volume	Cool (Hi / Lo)	m ³ /min	9,70/8,00/6,00	10,00/8,80/7,00	11,10/9,80/8,50
	Heat (Hi / Lo)	m ³ /min	9,90/8,20/6,00	10,30/9,20/7,00	11,10/9,80/8,50
Moisture removal volume		L/h	1,5	2,2	2,4
Sound pressure ⁴⁾	Cool (Hi / Med / Lo)	dB(A)	36/32/26	38/34/28	40/37/33
	Heat (Hi / Med / Lo)	dB(A)	36/32/26	38/34/28	40/37/33
Sound power	Cool (Hi)	dB	51/47/41	53/49/43	55/52/48
	Heat (Hi)	dB	51/47/41	53/49/43	55/52/48
Dimension (H x W x D)	Indoor	mm	288 x 583 x 583	288 x 583 x 583	288 x 583 x 583
	Panel CZ-KPY3AW	mm	31 x 700 x 700	31 x 700 x 700	31 x 700 x 700
	Panel CZ-KPY3BW	mm	31 x 625 x 625	31 x 625 x 625	31 x 625 x 625
Net weight	Indoor	kg	18	18	18
	Panel	kg	2,4	2,4	2,4
Piping connections	Liquid pipe	Inch (mm)	1/4 (6,35)	1/4 (6,35)	1/4 (6,35)
	Gas pipe	Inch (mm)	1/2 (12,70)	1/2 (12,70)	1/2 (12,70)
Operating range	Cool Min ~ Max	°C	+18 ~ +32	+18 ~ +32	+18 ~ +32
	Heat Min ~ Max	°C	+16 ~ +30	+16 ~ +30	+16 ~ +30

1) Only for multi combinations.
Recommended fuse for the indoor 3A.

1) EER and COP calculation is based in accordance to EN14511. 2) For models below 12 kW, the SEER and SCOP is calculated based on values of EU/626/2011. For models above 12 kW, the SEER and SCOP is calculated based on values of EU/2281/2016. 3) The annual energy consumption is calculated in accordance to EU/626/2011. 4) The sound pressure of the units shows the value measured of a position 1m in front of the main body and 1,5m from the ground. The sound pressure is measured in accordance with Eurovent 6/C/006-97 specification. 5) When installing the outdoor unit at a higher position than the indoor unit.* Recommended fuse for the indoor 3A.

R32

Kits 1x1



NEW
18



Panel
CZ-KPU3 (standard panel)
CZ-KPU3A (Econavi exclusive panel)



Econavi panel:
CZ-KPU3A (CZ-RTCSB
is required).



Optional nanoe™ X kit:
CZ-CNEXU1 (CZ-RTCSB
is required)

NEW PACi Elite 4 Way 90x90 Cassette Inverter+ • R32 GAS

Tentative data

			Single Phase							
			3,60 kW	5,00 kW	6,00 kW	7,10 kW	10,00 kW	12,50 kW	14,00 kW	
Kit			KIT-36PU2ZH5	KIT-50PU2ZH5	KIT-60PU2ZH5	KIT-71PU2ZH5	KIT-100PU2ZH5	KIT-125PU2ZH5	KIT-140PU2ZH5	
Remote controller			CZ-RTCSB	CZ-RTCSB	CZ-RTCSB	CZ-RTCSB	CZ-RTCSB	CZ-RTCSB	CZ-RTCSB	
Cooling capacity	Nominal (Min - Max)	kW	3,60 (1,50 - 4,00)	5,00 (1,50 - 5,60)	6,00 (2,00 - 7,10)	7,10 (2,20 - 9,00)	10,00 (3,10 - 12,50)	12,50 (3,20 - 14,00)	14,00 (3,30 - 16,00)	
EER ¹⁾		W/W	5,14	4,31	4,05	4,06	4,41	3,80	3,41	
SEER ²⁾		W/W	7,80 A++	7,80 A++	7,50 A++	7,70 A++	7,70 A++	7,70	7,20	
Pdesign		kW	3,60	5,00	6,00	7,10	10,00	12,50	14,00	
Input power cooling		kW	0,70	1,16	1,48	1,75	2,27	3,29	4,11	
Annual energy consumption ³⁾		kWh/a	—	—	—	—	—	—	—	
Heating capacity	Nominal (Min - Max)	kW	4,00 (1,50 - 5,00)	5,60 (1,50 - 6,50)	7,00 (1,80 - 8,00)	8,00 (2,00 - 9,00)	11,20 (3,30 - 14,00)	14,00 (3,40 - 16,00)	16,00 (3,50 - 18,00)	
Heating capacity at -7°C / -15°C ⁴⁾		kW	—	—	—	—	—	—	—	
COP ¹⁾		W/W	5,48	4,71	4,12	4,30	5,00	4,61	4,30	
SCOP ²⁾		W/W	5,10 A+++	4,90 A++	4,70 A++	4,80 A++	4,90 A++	4,70	4,60	
Pdesign at -10°C		kW	3,60	4,50	6,00	5,20	8,00	9,50	10,60	
Input power heating		kW	0,73	1,19	1,70	1,86	2,24	3,04	3,72	
Annual energy consumption ³⁾		kWh/a	—	—	—	—	—	—	—	
Indoor unit			S-36PU2E5B	S-50PU2E5B	S-60PU2E5B	S-71PU2E5B	S-100PU2E5B	S-125PU2E5B	S-140PU2E5B	
Air volume	Hi / Med / Lo	m ³ /min	14,5/13,0/11,5	16,5/13,5/11,5	21,0/16,0/13,0	22,0/16,0/13,0	36,0/26,0/18,0	37,0/27,0/19,0	38,0/29,0/20,0	
Sound pressure ⁵⁾	Hi / Med / Lo	dB(A)	30/28/27	32/29/27	36/31/28	37/31/28	45/38/32	46/39/33	47/40/34	
Dimension	Indoor (H x W x D)	mm	256 x 840 x 840	256 x 840 x 840	256 x 840 x 840	256 x 840 x 840	319 x 840 x 840	319 x 840 x 840	319 x 840 x 840	
	Panel (H x W x D)	mm	33,5 x 950 x 950	33,5 x 950 x 950	33,5 x 950 x 950	33,5 x 950 x 950	33,5 x 950 x 950	33,5 x 950 x 950	33,5 x 950 x 950	
Net weight	Indoor / Panel	kg	19/5	19/5	20/5	20/5	25/5	25/5	25/5	
Outdoor unit			U-36PZH2E5	U-50PZH2E5	U-60PZH2E5	U-71PZH2E5	U-100PZH2E5	U-125PZH2E5	U-140PZH2E5	
Power source		V	220/230/240	220/230/240	220/230/240	220/230/240	220/230/240	220/230/240	220/230/240	
Recommended fuse		A	—	—	—	—	—	—	—	
Connection indoor / outdoor		mm ²	—	—	—	—	—	—	—	
Current	Cool	A	—	—	—	—	—	—	—	
	Heat	A	—	—	—	—	—	—	—	
Air volume	Cool / Heat	m ³ /min	—	—	—	—	—	—	—	
Sound pressure	Cool / Heat (Hi)	dB(A)	45/46	46/48	46/49	48/50	52/52	53/53	54/55	
Sound power	Cool / Heat (Hi)	dB	64/66	65/68	65/69	65/67	69/69	70/70	71/71	
Dimension	H x W x D	mm	695 x 875 x 320	695 x 875 x 320	695 x 875 x 320	996 x 940 x 340	1416 x 940 x 340	1416 x 940 x 340	1416 x 940 x 340	
Net weight		kg	49	49	49	68	101	101	101	
Piping connections	Liquid pipe	Inch (mm)	1/4 (6,35)	1/4 (6,35)	3/8 (9,52)	3/8 (9,52)	3/8 (9,52)	3/8 (9,52)	3/8 (9,52)	
	Gas pipe	Inch (mm)	1/2 (12,70)	1/2 (12,70)	5/8 (15,88)	5/8 (15,88)	5/8 (15,88)	5/8 (15,88)	5/8 (15,88)	
Pipe length range		m	3 ~ 40	3 ~ 40	3 ~ 40	5 ~ 50	5 ~ 75	5 ~ 75	5 ~ 75	
Elevation difference (in/out) ⁶⁾		m	30	30	30	30	30	30	30	
Pipe length for additional gas		m	30	30	30	30	30	30	30	
Additional gas amount		g/m	—	—	—	—	—	—	—	
Refrigerant (R32)		kg / TCO ₂ Eq.	—	—	—	—	—	—	—	
Operating range	Cool Min ~ Max	°C	-15 ~ +46	-15 ~ +46	-15 ~ +46	-15 ~ +46	-15 ~ +46	-15 ~ +46	-15 ~ +46	
	Heat Min ~ Max	°C	-20 ~ +24	-20 ~ +24	-20 ~ +24	-20 ~ +24	-20 ~ +24	-20 ~ +24	-20 ~ +24	

Accessories

CZ-RTCSB	Wired remote controller with Econavi button and datanavi
CZ-RWS3 + CZ-RWRU3	Wireless remote controller
CZ-RE2C2	Simplified remote controller
CZ-CNEXU1	nanoe™ X air purifying system
CZ-KPU3A	Econavi exclusive panel

Accessories

PAW-WTRAY	Tray for condenser water compatible with base ground support
PAW-GRDBSE20	Outdoor base ground support for noise and vibration absorption



NEW PACi Elite 4 Way 90x90 Cassette Inverter+ • R32 GAS

Tentative data

			Three Phase			
			7,10 kW	10,00 kW	12,50 kW	14,00 kW
Kit			KIT-71PU2ZH8	KIT-100PU2ZH8	KIT-125PU2ZH8	KIT-140PU2ZH8
Remote controller			CZ-RTCSB	CZ-RTCSB	CZ-RTCSB	CZ-RTCSB
Cooling capacity	Nominal (Min - Max)	kW	7,10 (2,20 ~ 9,00)	10,00 (3,10 ~ 12,50)	12,50 (3,20 ~ 14,00)	14,00 (3,30 ~ 16,00)
EER ¹⁾		W/W	4,06	4,41	3,80	3,41
SEER ²⁾		W/W	7,60 A++	7,60 A++	7,60	7,20
Pdesign		kW	7,10	10,00	12,50	14,00
Input power cooling		kW	1,75	2,27	3,29	4,11
Annual energy consumption ³⁾		kWh/a	—	—	—	—
Heating capacity	Nominal (Min - Max)	kW	8,00 (2,00 ~ 9,00)	11,20 (3,30 ~ 14,00)	14,00 (3,40 ~ 16,00)	16,00 (3,50 ~ 18,00)
Heating capacity at -7°C / -15°C ⁴⁾		kW	—	—	—	—
COP ¹⁾		W/W	4,30	5,00	4,61	4,30
SCOP ²⁾		W/W	4,80 A++	4,90 A++	4,70	4,60
Pdesign at -10°C		kW	5,20	8,00	9,50	10,60
Input power heating		kW	1,86	2,24	3,04	3,72
Annual energy consumption ³⁾		kWh/a	—	—	—	—
Indoor unit			S-71PU2E5B	S-100PU2E5B	S-125PU2E5B	S-140PU2E5B
Air volume	Hi / Med / Lo	m ³ /min	22,0/16,0/13,0	36,0/26,0/18,0	37,0/27,0/19,0	38,0/29,0/20,0
Sound pressure ⁵⁾	Hi / Med / Lo	dB(A)	37/31/28	45/38/32	46/39/33	47/40/34
Dimension	Indoor (H x W x D)	mm	256 x 840 x 840	319 x 840 x 840	319 x 840 x 840	319 x 840 x 840
	Panel (H x W x D)	mm	33,5 x 950 x 950	33,5 x 950 x 950	33,5 x 950 x 950	33,5 x 950 x 950
Net weight	Indoor / Panel	kg	20/5	25/5	25/5	25/5
Outdoor unit			U-71PZH2E8	U-100PZH2E8	U-125PZH2E8	U-140PZH2E8
Power source		V	380/400/415	380/400/415	380/400/415	380/400/415
Recommended fuse		A	—	—	—	—
Connection indoor / outdoor		mm ²	—	—	—	—
Current	Cool	A	—	—	—	—
	Heat	A	—	—	—	—
Air volume	Cool / Heat	m ³ /min	—	—	—	—
Sound pressure	Cool / Heat (Hi)	dB(A)	48/50	52/52	53/53	54/55
Sound power	Cool / Heat (Hi)	dB	65/67	69/69	70/70	71/71
Dimension	HxWxD	mm	996 x 940 x 340	1416 x 940 x 340	1416 x 940 x 340	1416 x 940 x 340
Net weight		kg	68	101	101	101
Piping connections	Liquid pipe	Inch (mm)	3/8 (9,52)	3/8 (9,52)	3/8 (9,52)	3/8 (9,52)
	Gas pipe	Inch (mm)	5/8 (15,88)	5/8 (15,88)	5/8 (15,88)	5/8 (15,88)
Pipe length range		m	5 ~ 50	5 ~ 75	5 ~ 75	5 ~ 75
Elevation difference (in/out) ⁶⁾		m	30	30	30	30
Pipe length for additional gas		m	30	30	30	30
Additional gas amount		g/m	—	—	—	—
Refrigerant (R32)		kg/TCO ₂ Eq.	—	—	—	—
Operating range	Cool Min ~ Max	°C	-15 ~ +46	-15 ~ +46	-15 ~ +46	-15 ~ +46
	Heat Min ~ Max	°C	-20 ~ +24	-20 ~ +24	-20 ~ +24	-20 ~ +24

1) EER and COP calculation is based in accordance to EN14511. 2) For models below 12 kW, the SEER and SCOP is calculated based on values of EU/626/2011. For models above 12 kW, the SEER and SCOP is calculated based on values of EU/2281/2016. 3) The annual energy consumption is calculated in accordance to EU/626/2011. 4) Heating capacity is calculated including defrost factor correction. 5) The sound pressure of the units shows the value measured of a position 1m in front of the main body and 1,5 m from the ground. The sound pressure is measured in accordance with Eurovent 6/C/006-97 specification. 6) When installing the outdoor unit at a higher position than the indoor unit.* Recommended fuse for the indoor 3A.



SEER and SCOP: For KIT-36PU2ZH5, ECONAVI and INTERNET CONTROL: Optional.
Compatible with all Panasonic connectivity solutions. For detailed information go to the Control Systems section.

Rating Conditions: Cooling Indoor 27 °C DB / 19 °C WB, Cooling Outdoor 35 °C DB / 24 °C WB, Heating Indoor 20 °C DB, Heating Outdoor 7 °C DB / 6 °C WB. (DB: Dry Bulb; WB: Wet Bulb)
Specifications subject to change without notice. For detailed information about ErP / Energy Labelling, please visit our websites www.aircon.panasonic.eu or www.ptc.panasonic.eu.

R32

Kits 1x1



NEW
18



Panel
CZ-KPU3 (standard panel)
CZ-KPU3A (Econavi exclusive panel)



Econavi panel:
CZ-KPU3A (CZ-RTCSB
is required).



Optional nanoe™ X kit:
CZ-CNEXU1 (CZ-RTCSB
is required)

NEW PACi Standard 4 Way 90x90 Cassette Inverter+ • R32 GAS

Tentative data

			Single Phase				
			6,00 kW	7,10 kW	10,00 kW	12,50 kW	14,00 kW
Kit			KIT-60PU2Z5	KIT-71PU2Z5	KIT-100PU2Z5	KIT-125PU2Z5	KIT-140PU2Z5
Remote controller			CZ-RTCSB	CZ-RTCSB	CZ-RTCSB	CZ-RTCSB	CZ-RTCSB
Cooling capacity	Nominal (Min - Max)	kW	6,00 (2,00 ~ 7,10)	7,10 (2,00 ~ 7,70)	10,00 (3,00 - 11,50)	12,50 (3,20 - 13,50)	14,00 (3,30 - 15,00)
EER ¹⁾	Nominal (Min - Max)	W/W	3,92	3,43	3,82 (5,36 - 2,88)	3,58 (5,33 - 2,81)	3,23 (5,32 - 2,73)
SEER ²⁾	W/W	7,10 A++	6,60 A++	6,80 A++	6,75	6,51	
Pdesign		kW	6,00	7,10	10,00	12,50	14,00
Input power cooling	Nominal (Min - Max)	kW	1,53	2,07	2,62 (0,56 - 4,00)	3,49 (0,60 - 4,80)	4,34 (0,62 - 5,50)
Annual energy consumption ³⁾		kWh/a	—	—	515	—	—
Heating capacity	Nominal (Min - Max)	kW	6,00 (1,80 ~ 7,00)	7,10 (1,80 ~ 8,10)	10,00 (3,00 - 14,00)	12,50 (3,30 - 15,00)	14,00 (3,40 - 16,00)
Heating capacity at -7°C / -15°C ⁴⁾		kW	—	—	—	—	—
COP ¹⁾	Nominal (Min - Max)	W/W	4,44	4,18	4,93 (3,59 - 5,36)	4,43 (3,57 - 5,50)	4,18 (3,33 - 5,48)
SCOP ²⁾	W/W	4,60 A++	4,60 A++	4,40 A+	4,01	3,89	
Pdesign at -10°C		kW	6,00	6,00	10,00	12,50	14,00
Input power heating	Nominal (Min - Max)	kW	1,35	1,70	2,03 (0,56 - 3,90)	2,82 (0,60 - 4,20)	3,35 (0,62 - 4,80)
Annual energy consumption ³⁾		kWh/a	—	—	3182	—	—
Indoor unit			S-60PU2E5B	S-71PU2E5B	S-100PU2E5B	S-125PU2E5B	S-140PU2E5B
Air volume	Hi / Med / Lo	m ³ /min	21,0/16,0/13,0	22,0/16,0/13,0	36,0/26,0/18,0	37,0/27,0/19,0	38,0/29,0/20,0
Moisture removal volume		L/h	1,7	2,5	2,7	4,8	6,0
Sound pressure ⁵⁾	Hi / Med / Lo	dB(A)	36/31/28	37/31/28	45/38/32	46/39/33	47/40/34
Sound power	Hi / Med / Lo	dB	51/46/43	52/46/43	60/53/47	61/54/48	62/55/49
Dimension	Indoor (H x W x D)	mm	256 x 840 x 840	256 x 840 x 840	319 x 840 x 840	319 x 840 x 840	319 x 840 x 840
	Panel (H x W x D)	mm	33,5 x 950 x 950	33,5 x 950 x 950	33,5 x 950 x 950	33,5 x 950 x 950	33,5 x 950 x 950
Net weight	Indoor / Panel	kg	20/5	20/5	25/5	25/5	25/5
Outdoor unit			U-60PZ2E5	U-71PZ2E5	U-100PZ2E5	U-125PZ2E5	U-140PZ2E5
Power source		V	220/230/240	220/230/240	220/230/240	220/230/240	220/230/240
Current	Cool	A	—	—	12,10/11,50/11,10	16,30/15,60/15,00	20,40/19,50/18,70
	Heat	A	—	—	9,25/8,85/8,50	13,10/12,60/12,00	15,60/15,00/14,30
Air volume	Cool / Heat	m ³ /min	—	—	76/70	86/78	89/83
Sound pressure	Cool / Heat (Hi)	dB(A)	46/48	49/49	52/52	55/55	56/56
Sound power	Cool / Heat (Hi)	dB	65/68	69/69	70/70	73/73	74/74
Dimension	H x W x D	mm	695 x 875 x 320	695 x 875 x 320	996 x 980 x 370	996 x 980 x 370	996 x 980 x 370
Net weight		kg	49	49	90	94	94
Piping connections	Liquid pipe	Inch (mm)	3/8 (9,52)	3/8 (9,52)	3/8 (9,52)	3/8 (9,52)	3/8 (9,52)
	Gas pipe	Inch (mm)	5/8 (15,88)	5/8 (15,88)	5/8 (15,88)	5/8 (15,88)	5/8 (15,88)
Pipe length range		m	3 ~ 40	3 ~ 40	5 ~ 50	5 ~ 50	5 ~ 50
Elevation difference (in/out) ⁶⁾		m	30	30	30	30	30
Pipe length for additional gas		m	30	30	30	30	30
Additional gas amount		g/m	—	—	45	45	45
Refrigerant (R32)		kg/TCO ₂ Eq.	—	—	2,60/1,755	2,98/2,0115	2,98/2,0115
Operating range	Cool Min ~ Max	°C	-10 ~ +43	-10 ~ +43	-10 ~ +43	-10 ~ +43	-10 ~ +43
	Heat Min ~ Max	°C	-15 ~ +24	-15 ~ +24	-15 ~ +24	-15 ~ +24	-15 ~ +24

Accessories

CZ-RTCSB	Wired remote controller with Econavi button and datanavi
CZ-RWS3 + CZ-RWRU3	Wireless remote controller
CZ-RE2C2	Simplified remote controller
CZ-CNEXU1	nanoe™ X air purifying system
CZ-KPU3A	Econavi exclusive panel

Accessories

PAW-WTRAY	Tray for condenser water compatible with base ground support
PAW-GRDBSE20	Outdoor base ground support for noise and vibration absorption

Kits 1x1

R32



NEW PACi Standard 4 Way 90x90 Cassette Inverter+ • R32 GAS

Tentative data

			Three Phase		
			10,00 kW	12,50 kW	14,00 kW
Kit			KIT-100PU2Z8	KIT-125PU2Z8	KIT-140PU2Z8
Remote controller			CZ-RTC5B	CZ-RTC5B	CZ-RTC5B
Cooling capacity	Nominal (Min - Max)	kW	10,00 (3,00 - 11,50)	12,50 (3,20 - 13,50)	14,00 (3,30 - 15,00)
EER ¹⁾	Nominal (Min - Max)	W/W	3,82 (5,36 - 2,88)	3,58 (5,33 - 2,81)	3,23 (5,32 - 2,73)
SEER ²⁾	W/W	6,70 A++	6,73	6,49	
Pdesign		kW	10,00	12,50	14,00
Input power cooling	Nominal (Min - Max)	kW	2,62 (0,56 - 4,00)	3,49 (0,60 - 4,80)	4,34 (0,62 - 5,50)
Annual energy consumption ³⁾		kWh/a	521	—	—
Heating capacity	Nominal (Min - Max)	kW	10,00 (3,00 - 14,00)	12,50 (3,30 - 15,00)	14,00 (3,40 - 16,00)
Heating capacity at -7°C / -15°C ⁴⁾		kW	—	—	—
COP ¹⁾	Nominal (Min - Max)	W/W	4,93 (3,59 - 5,36)	4,43 (3,57 - 5,50)	4,18 (3,33 - 5,48)
SCOP ²⁾	W/W	4,40 A+	4,01	3,89	
Pdesign at -10°C		kW	10,00	12,50	14,00
Input power heating	Nominal (Min - Max)	kW	2,03 (0,56 - 3,90)	2,82 (0,60 - 4,20)	3,35 (0,62 - 4,80)
Annual energy consumption ³⁾		kWh/a	3182	—	—
Indoor unit			S-100PU2E5B	S-125PU2E5B	S-140PU2E5B
Air volume	Hi / Med / Lo	m ³ /min	36,0/26,0/18,0	37,0/27,0/19,0	38,0/29,0/20,0
Moisture removal volume		L/h	2,7	4,8	6,0
Sound pressure ⁵⁾	Hi / Med / Lo	dB(A)	45/38/32	46/39/33	47/40/34
Sound power	Hi / Med / Lo	dB	60/53/47	61/54/48	62/55/49
Dimension	Indoor (H x W x D)	mm	319 x 840 x 840	319 x 840 x 840	319 x 840 x 840
	Panel (H x W x D)	mm	33,5 x 950 x 950	33,5 x 950 x 950	33,5 x 950 x 950
Net weight	Indoor / Panel	kg	25/5	25/5	25/5
Outdoor unit			U-100PZ2E8	U-125PZ2E8	U-140PZ2E8
Power source		V	380/400/415	380/400/415	380/400/415
Current	Cool	A	4,10/3,90/3,75	5,45/5,20/5,00	6,85/6,50/6,25
	Heat	A	3,15/3,00/2,90	4,40/4,15/4,00	5,25/4,95/4,80
Air volume	Cool / Heat	m ³ /min	76/70	86/78	89/83
Sound pressure	Cool / Heat (Hi)	dB(A)	52/52	55/55	56/56
Sound power	Cool / Heat (Hi)	dB	70/70	73/73	74/74
Dimension	HxWxD	mm	996 x 980 x 370	996 x 980 x 370	996 x 980 x 370
Net weight		kg	90	94	94
Piping connections	Liquid pipe	Inch (mm)	3/8 (9,52)	3/8 (9,52)	3/8 (9,52)
	Gas pipe	Inch (mm)	5/8 (15,88)	5/8 (15,88)	5/8 (15,88)
Pipe length range		m	5 - 50	5 - 50	5 - 50
Elevation difference (in/out) ⁶⁾		m	30	30	30
Pipe length for additional gas		m	30	30	30
Additional gas amount		g/m	45	45	45
Refrigerant (R32)		kg/TCO ₂ Eq.	2,60/1,755	2,98/2,0115	2,98/2,0115
Operating range	Cool Min ~ Max	°C	-10 ~ +43	-10 ~ +43	-10 ~ +43
	Heat Min ~ Max	°C	-15 ~ +24	-15 ~ +24	-15 ~ +24

1) EER and COP calculation is based in accordance to EN14511. 2) For models below 12 kW, the SEER and SCOP is calculated based on values of EU/626/2011. For models above 12 kW, the SEER and SCOP is calculated based on values of EU/2281/2016. 3) The annual energy consumption is calculated in accordance to EU/626/2011. 4) Heating capacity is calculated including defrost factor correction. 5) The sound pressure of the units shows the value measured of a position 1m in front of the main body and 1,5 m from the ground. The sound pressure is measured in accordance with Eurovent 6/C/006-97 specification. 6) When installing the outdoor unit at a higher position than the indoor unit.* Recommended fuse for the indoor 3A.

R32

7,10 SEER

4,68 SCOP

28%

-10°C

-15°C

99%

SEER and SCOP: For KIT-60PU2Z5. ECONAVI and INTERNET CONTROL: Optional.
Compatible with all Panasonic connectivity solutions. For detailed information go to the Control Systems section.

Rating Conditions: Cooling Indoor 27 °C DB / 19 °C WB. Cooling Outdoor 35 °C DB / 24 °C WB. Heating Indoor 20 °C DB. Heating Outdoor 7 °C DB / 6 °C WB. (DB: Dry Bulb; WB: Wet Bulb)
Specifications subject to change without notice. For detailed information about ErP / Energy Labelling, please visit our websites www.aircon.panasonic.eu or www.ptc.panasonic.eu.

R32

Kits 1x1



NEW
18

NEW PACi Elite Ceiling Inverter+ • R32 GAS

Tentative data

		Single Phase							
		3,60 kW	5,00 kW	6,00 kW	7,10 kW	10,00 kW	12,50 kW	14,00 kW	
Kit		KIT-36PT2ZH5	KIT-50PT2ZH5	KIT-60PT2ZH5	KIT-71PT2ZH5	KIT-100PT2ZH5	KIT-125PT2ZH5	KIT-140PT2ZH5	
Remote controller		CZ-RTC5B	CZ-RTC5B	CZ-RTC5B	CZ-RTC5B	CZ-RTC5B	CZ-RTC5B	CZ-RTC5B	
Cooling capacity	kW	3,60	5,00	6,00	7,10	10,00	12,50	14,00	
EER ¹⁾	W/W	5,14	4,07	3,92	3,76	4,03	3,41	3,08	
SEER ²⁾	W/W	6,90 A++	6,90 A++	6,80 A++	6,20 A++	6,70 A++	6,10	5,70	
Pdesign	kW	3,60	5,00	6,00	7,10	10,00	12,50	14,00	
Input power cooling	kW	0,70	1,23	1,53	1,89	2,48	3,67	4,55	
Annual energy consumption ³⁾	kWh/a	—	—	—	—	—	—	—	
Heating capacity	kW	4,00	5,60	7,00	8,00	11,20	14,00	16,00	
Heating capacity at -7°C / -15°C ⁴⁾	kW	—	—	—	—	—	—	—	
COP ¹⁾	W/W	5,26	4,34	4,24	4,15	4,31	3,99	3,67	
SCOP ²⁾	W/W	4,50 A+	4,30 A+	4,30 A+	4,20 A+	4,30 A+	4,10	4,00	
Pdesign at -10°C	kW	3,60	4,50	6,00	5,20	8,00	9,50	10,60	
Input power heating	kW	0,76	1,29	1,65	1,93	2,60	3,51	4,36	
Annual energy consumption ³⁾	kWh/a	—	—	—	—	—	—	—	
Indoor unit		S-36PT2E5B	S-50PT2E5B	S-60PT2E5B	S-71PT2E5B	S-100PT2E5B	S-125PT2E5B	S-140PT2E5B	
Air volume	Hi / Med / Lo	m ³ /min	14,0/12,0/10,5	15,0/12,5/10,5	20,0/17,0/14,5	21,0/18,0/15,5	30,0/25,0/23,0	34,0/28,0/24,0	35,0/29,0/25,0
Sound pressure ⁵⁾	Hi / Med / Lo	dB(A)	36/32/29	37/33/29	38/34/30	39/35/31	42/37/35	46/40/36	47/41/37
Dimension	H x W x D	mm	235 x 960 x 690	235 x 960 x 690	235 x 1275 x 690	235 x 1275 x 690	235 x 1590 x 690	235 x 1590 x 690	235 x 1590 x 690
Net weight	Indoor / Panel	kg	27	27	33	33	40	40	40
Outdoor unit		U-36PZH2E5	U-50PZH2E5	U-60PZH2E5	U-71PZH2E5	U-100PZH2E5	U-125PZH2E5	U-140PZH2E5	
Power source	V	220/230/240	220/230/240	220/230/240	220/230/240	220/230/240	220/230/240	220/230/240	
Recommended fuse	A	—	—	—	—	—	—	—	
Current	Cool	A	—	—	—	—	—	—	
	Heat	A	—	—	—	—	—	—	
Air volume	Cool / Heat	m ³ /min	—	—	—	—	—	—	
Sound pressure	Cool / Heat (Hi)	dB(A)	45/46	46/48	46/49	48/50	52/52	53/53	54/55
Sound power	Cool / Heat (Hi)	dB	64/66	65/68	65/69	65/67	69/69	70/70	71/71
Dimension	H x W x D	mm	695 x 875 x 320	695 x 875 x 320	695 x 875 x 320	996 x 940 x 340	1416 x 940 x 340	1416 x 940 x 340	1416 x 940 x 340
Net weight	kg	49	49	49	68	101	101	101	
Piping connections	Liquid pipe	Inch (mm)	1/4(6,35)	1/4(6,35)	3/8(9,52)	3/8(9,52)	3/8(9,52)	3/8(9,52)	3/8(9,52)
	Gas pipe	Inch (mm)	1/2(12,70)	1/2(12,70)	5/8(15,88)	5/8(15,88)	5/8(15,88)	5/8(15,88)	5/8(15,88)
Pipe length range	m	3 ~ 40	3 ~ 40	3 ~ 40	5 ~ 50	5 ~ 75	5 ~ 75	5 ~ 75	
Elevation difference (in/out) ⁶⁾	m	30	30	30	30	30	30	30	
Pipe length for additional gas	m	30	30	30	30	30	30	30	
Additional gas amount	g/m	—	—	—	—	—	—	—	
Refrigerant (R32)	kg/TCO ₂ Eq.	—	—	—	—	—	—	—	
Operating range	Cool Min ~ Max	°C	-15 ~ +46	-15 ~ +46	-15 ~ +46	-15 ~ +46	-15 ~ +46	-15 ~ +46	-15 ~ +46
	Heat Min ~ Max	°C	-20 ~ +24	-20 ~ +24	-20 ~ +24	-20 ~ +24	-20 ~ +24	-20 ~ +24	-20 ~ +24

Accessories

CZ-RTC5B	Wired remote controller with Econavi button and datanavi
CZ-RWS3 + CZ-RWRT3	Wireless remote controller
CZ-RE2C2	Simplified remote controller
PAW-WTRAY	Tray for condenser water compatible with base ground support

Accessories

PAW-GRDBSE20	Outdoor base ground support for noise and vibration absorption
PAW-GRDSTD40	Outdoor elevation platform 400 x 900 x 400mm



NEW PACi Elite Ceiling Inverter+ • R32 GAS

Tentative data

		Three Phase				
		7,10 kW	10,00 kW	12,50 kW	14,00 kW	
Kit		KIT-71PT2ZH8	KIT-100PT2ZH8	KIT-125PT2ZH8	KIT-140PT2ZH8	
Remote controller		CZ-RTC5B	CZ-RTC5B	CZ-RTC5B	CZ-RTC5B	
Cooling capacity	kW	7,10	10,00	12,50	14,00	
EER ¹⁾	W/W	3,76	4,03	3,41	3,08	
SEER ²⁾	W/W	6,00 A+	6,70 A++	6,10	5,70	
Pdesign	kW	7,10	10,00	12,50	14,00	
Input power cooling	kW	1,89	2,48	3,67	4,55	
Annual energy consumption ³⁾	kWh/a	—	—	—	—	
Heating capacity	kW	8,00	11,20	14,00	16,00	
Heating capacity at -7°C / -15°C ⁴⁾	kW	—	—	—	—	
COP ¹⁾	W/W	4,15	4,31	3,99	3,67	
SCOP ²⁾	W/W	4,20 A+	4,30 A+	4,10	4,00	
Pdesign at -10°C	kW	5,20	8,00	9,50	10,60	
Input power heating	kW	1,93	2,60	3,51	4,36	
Annual energy consumption ³⁾	kWh/a	—	—	—	—	
Indoor unit		S-71PT2E5B	S-100PT2E5B	S-125PT2E5B	S-140PT2E5B	
Air volume	Hi / Med / Lo	m ³ /min	21,0/18,0/15,5	30,0/25,0/23,0	34,0/28,0/24,0	35,0/29,0/25,0
Sound pressure ⁵⁾	Hi / Med / Lo	dB(A)	39/35/31	42/37/35	46/40/36	47/41/37
Dimension	H x W x D	mm	235 x 1275 x 690	235 x 1590 x 690	235 x 1590 x 690	235 x 1590 x 690
Net weight	Indoor / Panel	kg	33	40	40	40
Outdoor unit		U-71PZH2E8	U-100PZH2E8	U-125PZH2E8	U-140PZH2E8	
Power source	V	380/400/415	380/400/415	380/400/415	380/400/415	
Recommended fuse	A	—	—	—	—	
Current	Cool	A	—	—	—	
	Heat	A	—	—	—	
Air volume	Cool / Heat	m ³ /min	—	—	—	
Sound pressure	Cool / Heat (Hi)	dB(A)	48/50	52/52	53/53	54/55
Sound power	Cool / Heat (Hi)	dB	65/67	69/69	70/70	71/71
Dimension	H x W x D	mm	996 x 940 x 340	1416 x 940 x 340	1416 x 940 x 340	1416 x 940 x 340
Net weight	kg	68	101	101	101	
Piping connections	Liquid pipe	Inch (mm)	3/8(9,52)	3/8(9,52)	3/8(9,52)	3/8(9,52)
	Gas pipe	Inch (mm)	5/8(15,88)	5/8(15,88)	5/8(15,88)	5/8(15,88)
Pipe length range	m	5 ~ 50	5 ~ 75	5 ~ 75	5 ~ 75	
Elevation difference (in/out) ⁶⁾	m	30	30	30	30	
Pipe length for additional gas	m	30	30	30	30	
Additional gas amount	g/m	—	—	—	—	
Refrigerant (R32)	kg/TCO ₂ Eq.	—	—	—	—	
Operating range	Cool Min ~ Max	°C	-15 ~ +46	-15 ~ +46	-15 ~ +46	-15 ~ +46
	Heat Min ~ Max	°C	-20 ~ +24	-20 ~ +24	-20 ~ +24	-20 ~ +24

1) EER and COP calculation is based in accordance to EN14511. 2) For models below 12 kW, the SEER and SCOP is calculated based on values of EU/626/2011. For models above 12 kW, the SEER and SCOP is calculated based on values of EU/2281/2016. 3) The annual energy consumption is calculated in accordance to EU/626/2011. 4) Heating capacity is calculated including defrost factor correction. 5) The sound pressure of the units shows the value measured of a position 1m in front of the main body and 1,5 m from the ground. The sound pressure is measured in accordance with Eurovent 6/C/006-97 specification. 6) When installing the outdoor unit at a higher position than the indoor unit.* Recommended fuse for the indoor 3A.



SEER and SCOP: For KIT-36PT2ZH5. INTERNET CONTROL: Optional.
Compatible with all Panasonic connectivity solutions. For detailed information go to the Control Systems section.

Rating Conditions: Cooling Indoor 27 °C DB / 19 °C WB. Cooling Outdoor 35 °C DB / 24 °C WB. Heating Indoor 20 °C DB. Heating Outdoor 7 °C DB / 6 °C WB. (DB: Dry Bulb; WB: Wet Bulb)
Specifications subject to change without notice. For detailed information about ErP / Energy Labelling, please visit our websites www.aircon.panasonic.eu or www.ptc.panasonic.eu.

R32

Kits 1x1



NEW
18

NEW PACi Standard Ceiling Inverter+ • R32 GAS

Tentative data

			Single Phase				
			6,00 kW	7,10 kW	10,00 kW	12,50 kW	14,00 kW
Kit			KIT-60PT2Z5	KIT-71PT2Z5	KIT-100PT2Z5	KIT-125PT2Z5	KIT-140PT2Z5
Remote controller			CZ-RTC5B	CZ-RTC5B	CZ-RTC5B	CZ-RTC5B	CZ-RTC5B
Cooling capacity	Nominal (Min - Max)	kW	6,00	7,10	10,00 (3,00 - 11,50)	12,50 (3,20 - 13,50)	14,00 (3,30 - 15,00)
EER ¹⁾	Nominal (Min - Max)	W/W	3,82	3,33	3,64 (5,36 - 2,80)	3,32 (5,33 - 2,77)	2,98 (5,32 - 2,73)
SEER ²⁾	W/W	6,70A++	6,10A++	6,50A++	5,77	5,49	
Pdesign		kW	6,00	7,10	10,00	12,50	14,00
Input power cooling	Nominal (Min - Max)	kW	1,57	2,13	2,75 (0,56 - 4,10)	3,76 (0,60 - 4,88)	4,70 (0,62 - 5,50)
Annual energy consumption ³⁾		kWh/a	—	—	535	1300	1530
Heating capacity	Nominal (Min - Max)	kW	6,00	7,10	10,00 (3,00 - 14,00)	12,50 (3,30 - 15,00)	14,00 (3,40 - 16,00)
Heating capacity at -7°C / -15°C ⁴⁾		kW	—	—	8,85 / 6,40	11,00 / 8,00	12,00 / 8,40
COP ¹⁾	Nominal (Min - Max)	W/W	4,51	4,25	4,24 (5,36 - 3,50)	3,89 (4,52 - 3,41)	3,70 (5,48 - 3,08)
SCOP ²⁾	W/W	4,20A+	4,20A+	4,20A+	3,75	3,70	
Pdesign at -10°C		kW	6,00	6,00	10,00	12,50	13,60
Input power heating	Nominal (Min - Max)	kW	1,33	1,67	2,36 (0,56 - 4,00)	3,21 (0,73 - 4,40)	3,78 (0,62 - 5,20)
Annual energy consumption ³⁾		kWh/a	—	—	3324	4669	5153
Indoor unit			S-60PT2E5B	S-71PT2E5B	S-100PT2E5B	S-125PT2E5B	S-140PT2E5B
Air volume	Hi / Med / Lo	m ³ /min	20,0 / 17,0 / 14,5	21,0 / 18,0 / 15,5	30/25/23	34/28/24	35/29/25
Moisture removal volume		L/h	3,4	4,2	6,0	7,9	9,0
Sound pressure ⁵⁾	Hi / Med / Lo	dB(A)	38/34/30	39/35/31	42/37/35	46/40/36	47/41/37
Sound power	Hi / Med / Lo	dB	56/52/48	57/53/49	60/55/53	64/58/54	65/59/55
Dimension	HxWxD	mm	235 x 1275 x 690	235 x 1275 x 690	235 x 1590 x 690	235 x 1590 x 690	235 x 1590 x 690
Net weight		kg	33	33	40	40	40
Outdoor unit			U-60PZ2E5	U-71PZ2E5	U-100PZ2E5	U-125PZ2E5	U-140PZ2E5
Power source		V	220 / 230 / 240	220 / 230 / 240	220 / 230 / 240	220 / 230 / 240	220 / 230 / 240
Current	Cool	A	—	—	12,80 / 12,20 / 11,70	17,60 / 16,90 / 16,20	22,10 / 21,20 / 20,30
	Heat	A	—	—	10,90 / 10,40 / 10,00	15,00 / 14,30 / 13,70	17,70 / 16,90 / 16,20
Air volume	Cool / Heat	m ³ /min	—	—	76/70	86/78	89/83
Sound pressure	Cool / Heat (Hi)	dB(A)	46/48	49/49	52/52	55/55	56/56
Sound power	Cool / Heat (Hi)	dB	65/68	69/69	70/70	73/73	74/74
Dimension	HxWxD	mm	695 x 875 x 320	695 x 875 x 320	996 x 980 x 370	996 x 980 x 370	996 x 980 x 370
Net weight		kg	49	49	90	94	94
Piping connections	Liquid pipe	Inch (mm)	3/8 (9,52)	3/8 (9,52)	3/8 (9,52)	3/8 (9,52)	3/8 (9,52)
	Gas pipe	Inch (mm)	5/8 (15,88)	5/8 (15,88)	5/8 (15,88)	5/8 (15,88)	5/8 (15,88)
Pipe length range		m	3 ~ 40	3 ~ 40	5 ~ 50	5 ~ 50	5 ~ 50
Elevation difference (in/out) ⁶⁾		m	30	30	30	30	30
Pipe length for additional gas		m	30	30	30	30	30
Additional gas amount		g/m	—	—	45	45	45
Refrigerant (R32)		kg/TCO ₂ Eq.	—	—	2,60 / 1,755	2,98 / 2,0115	2,98 / 2,0115
Operating range	Cool Min ~ Max	°C	-10 ~ +43	-10 ~ +43	-10 ~ +43	-10 ~ +43	-10 ~ +43
	Heat Min ~ Max	°C	-15 ~ +24	-15 ~ +24	-15 ~ +24	-15 ~ +24	-15 ~ +24

Accessories

CZ-RTC5B	Wired remote controller with Econavi button and datanavi
CZ-RWS3 + CZ-RWRT3	Wireless remote controller
CZ-RE2C2	Simplified remote controller
PAW-WTRAY	Tray for condenser water compatible with base ground support

Accessories

PAW-GRDBSE20	Outdoor base ground support for noise and vibration absorption
PAW-GRDSTD40	Outdoor elevation platform 400 x 900 x 400mm

Kits 1x1

R32



NEW PACi Standard Ceiling Inverter+ • R32 GAS

Tentative data

			Three Phase		
			10,00 kW	12,50 kW	14,00 kW
Kit			KIT-100PT2Z8	KIT-125PT2Z8	KIT-140PT2Z8
Remote controller			CZ-RTC5B	CZ-RTC5B	CZ-RTC5B
Cooling capacity	Nominal (Min - Max)	kW	10,00 (3,00 - 11,50)	12,50 (3,20 - 13,50)	14,00 (3,30 - 15,00)
EER ¹⁾	Nominal (Min - Max)	W/W	3,64 (5,36 - 2,80)	3,32 (5,33 - 2,77)	2,98 (5,32 - 2,73)
SEER ²⁾	W/W	6,50 A++	5,75	5,48	
Pdesign		kW	10,00	12,50	14,00
Input power cooling	Nominal (Min - Max)	kW	2,75 (0,56 - 4,10)	3,76 (0,60 - 4,88)	4,70 (0,62 - 5,50)
Annual energy consumption ³⁾		kWh/a	538	1304	1534
Heating capacity	Nominal (Min - Max)	kW	10,00 (3,00 - 14,00)	12,50 (3,30 - 15,00)	14,00 (3,40 - 16,00)
Heating capacity at -7°C / -15°C ⁴⁾		kW	8,85 / 6,40	11,00 / 8,00	12,00 / 8,40
COP ¹⁾	Nominal (Min - Max)	W/W	4,24 (5,36 - 3,50)	3,89 (4,52 - 3,41)	3,70 (5,48 - 3,08)
SCOP ²⁾	W/W	4,20 A+	3,75	3,70	
Pdesign at -10°C		kW	10,00	12,50	13,60
Input power heating	Nominal (Min - Max)	kW	2,36 (0,56 - 4,00)	3,21 (0,73 - 4,40)	3,78 (0,62 - 5,20)
Annual energy consumption ³⁾		kWh/a	3324	4669	5153
Indoor unit			S-100PT2E5B	S-125PT2E5B	S-140PT2E5B
Air volume	Hi / Med / Lo	m ³ /min	30/25/23	34/28/24	35/29/25
Moisture removal volume		L/h	6,0	7,9	9,0
Sound pressure ⁵⁾	Hi / Med / Lo	dB(A)	42/37/35	46/40/36	47/41/37
Sound power	Hi / Med / Lo	dB	60/55/53	64/58/54	65/59/55
Dimension	H x W x D	mm	235 x 1590 x 690	235 x 1590 x 690	235 x 1590 x 690
Net weight		kg	40	40	40
Outdoor unit			U-100PZ2E8	U-125PZ2E8	U-140PZ2E8
Power source		V	380/400/415	380/400/415	380/400/415
Current	Cool	A	4,37/4,15/4,00	5,90/5,60/5,40	7,40/7,05/6,80
	Heat	A	3,72/3,55/3,40	5,00/4,75/4,60	5,90/5,60/5,40
Air volume	Cool / Heat	m ³ /min	76/70	86/78	89/83
Sound pressure	Cool / Heat (Hi)	dB(A)	52/52	55/55	56/56
Sound power	Cool / Heat (Hi)	dB	70/70	73/73	74/74
Dimension	H x W x D	mm	996 x 980 x 370	996 x 980 x 370	996 x 980 x 370
Net weight		kg	90	94	94
Piping connections	Liquid pipe	Inch (mm)	3/8 (9,52)	3/8 (9,52)	3/8 (9,52)
	Gas pipe	Inch (mm)	5/8 (15,88)	5/8 (15,88)	5/8 (15,88)
Pipe length range		m	5 - 50	5 - 50	5 - 50
Elevation difference (in/out) ⁶⁾		m	30	30	30
Pipe length for additional gas		m	30	30	30
Additional gas amount		g/m	45	45	45
Refrigerant (R32)		kg/TCO: Eq.	2,60/1,755	2,98/2,0115	2,98/2,0115
Operating range	Cool Min ~ Max	°C	-10 ~ +43	-10 ~ +43	-10 ~ +43
	Heat Min ~ Max	°C	-15 ~ +24	-15 ~ +24	-15 ~ +24

1) EER and COP calculation is based in accordance to EN14511. 2) For models below 12 kW, the SEER and SCOP is calculated based on values of EU/626/2011. For models above 12 kW, the SEER and SCOP is calculated based on values of EU/2281/2016. 3) The annual energy consumption is calculated in accordance to EU/626/2011. 4) Heating capacity is calculated including defrost factor correction. 5) The sound pressure of the units shows the value measured of a position 1m in front of the main body and 1,5 m from the ground. The sound pressure is measured in accordance with Eurovent 6/C/006-97 specification. 6) When installing the outdoor unit at a higher position than the indoor unit. * Recommended fuse for the indoor 3A.



SEER and SCOP: For KIT-60PT2Z5. INTERNET CONTROL: Optional.
Compatible with all Panasonic connectivity solutions. For detailed information go to the Control Systems section.

Rating Conditions: Cooling Indoor 27 °C DB / 19 °C WB, Cooling Outdoor 35 °C DB / 24 °C WB, Heating Indoor 20 °C DB, Heating Outdoor 7 °C DB / 6 °C WB. (DB: Dry Bulb; WB: Wet Bulb)
Specifications subject to change without notice. For detailed information about ErP / Energy Labelling, please visit our websites www.aircon.panasonic.eu or www.ptc.panasonic.eu.

R32

Kits 1x1



NEW PACi Elite High Static Pressure Hide Away Inverter+ • R32 GAS

Tentative data

			Single Phase						
			3,60 kW	5,00 kW	6,00 kW	7,10 kW	10,00 kW	12,50 kW	14,00 kW
Kit			KIT-36PF1ZH5	KIT-50PF1ZH5	KIT-60PF1ZH5	KIT-71PF1ZH5	KIT-100PF1ZH5	KIT-125PF1ZH5	KIT-140PF1ZH5
Remote controller			CZ-RTC5B	CZ-RTC5B	CZ-RTC5B	CZ-RTC5B	CZ-RTC5B	CZ-RTC5B	CZ-RTC5B
Cooling capacity	kW		3,60	5,00	6,00	7,10	10,00	12,50	14,00
EER ¹⁾	W/W		4,74	4,20	3,85	3,92	4,18	3,56	3,32
SEER ²⁾	W/W		5,90A+	6,00A+	6,10A++	6,40A++	5,80A+	5,90	5,80
Pdesign	kW		3,60	5,00	6,00	7,10	10,00	12,50	14,00
Input power cooling	kW		0,76	1,19	1,56	1,81	2,39	3,51	4,22
Annual energy consumption ³⁾	kWh/a		—	—	—	—	—	—	—
Heating capacity	kW		4,00	5,60	7,00	8,00	11,20	14,00	16,00
Heating capacity at -7°C / -15°C ⁴⁾	kW		—	—	—	—	—	—	—
COP ¹⁾	W/W		4,76	4,18	4,02	3,85	4,31	4,02	3,60
SCOP ²⁾	W/W		4,10A+	4,10A+	4,20A+	4,20A+	3,80A	4,00	3,90
Pdesign at -10°C	kW		3,60	4,00	6,00	5,20	8,00	9,50	10,60
Input power heating	kW		0,84	1,34	1,74	2,08	2,60	3,48	4,44
Annual energy consumption ³⁾	kWh/a		—	—	—	—	—	—	—
Indoor unit			S-36PF1E5B	S-50PF1E5B	S-60PF1E5B	S-71PF1E5B	S-100PF1E5B	S-125PF1E5B	S-140PF1E5B
External static pressure ⁵⁾ Nominal (Min - Max)	Pa		70(10 - 150)	70(10 - 150)	70(10 - 150)	70(10 - 150)	100(10 - 150)	100(10 - 150)	100(10 - 150)
Air volume	Hi / Med / Lo	m ³ /min	14,0/13,0/10,0	16,0/15,0/12,0	21,0/19,0/15,0	21,0/19,0/15,0	32,0/26,0/21,0	34,0/29,0/23,0	36,0/32,0/25,0
Sound pressure ⁵⁾	Hi / Med / Lo	dB(A)	33/29/25	34/30/26	35/32/26	35/32/26	38/34/31	39/35/32	40/36/33
Dimension	H x W x D	mm	290 x 800 x 700	290 x 800 x 700	290 x 1000 x 700	290 x 1000 x 700	290 x 1400 x 700	290 x 1400 x 700	290 x 1400 x 700
Net weight	Indoor / Panel	kg	28	28	33	33	45	45	45
Outdoor unit			U-36PZH2E5	U-50PZH2E5	U-60PZH2E5	U-71PZH2E5	U-100PZH2E5	U-125PZH2E5	U-140PZH2E5
Power source		V	220/230/240	220/230/240	220/230/240	220/230/240	220/230/240	220/230/240	220/230/240
Recommended fuse		A	—	—	—	—	—	—	—
Current	Cool	A	—	—	—	—	—	—	—
	Heat	A	—	—	—	—	—	—	—
Air volume	Cool / Heat	m ³ /min	—	—	—	—	—	—	—
Sound pressure	Cool / Heat (Hi)	dB(A)	45/46	46/48	46/49	48/50	52/52	53/53	54/55
Sound power	Cool / Heat (Hi)	dB	64/66	65/68	65/69	65/67	69/69	70/70	71/71
Dimension	H x W x D	mm	695 x 875 x 320	695 x 875 x 320	695 x 875 x 320	996 x 940 x 340	1416 x 940 x 340	1416 x 940 x 340	1416 x 940 x 340
Net weight		kg	49	49	49	68	101	101	101
Piping connections	Liquid pipe	Inch (mm)	1/4(6,35)	1/4(6,35)	3/8(9,52)	3/8(9,52)	3/8(9,52)	3/8(9,52)	3/8(9,52)
	Gas pipe	Inch (mm)	1/2(12,70)	1/2(12,70)	5/8(15,88)	5/8(15,88)	5/8(15,88)	5/8(15,88)	5/8(15,88)
Pipe length range		m	3~40	3~40	3~40	5~50	5~75	5~75	5~75
Elevation difference (in/out) ⁶⁾		m	30	30	30	30	30	30	30
Pipe length for additional gas		m	30	30	30	30	30	30	30
Additional gas amount		g/m	—	—	—	—	—	—	—
Refrigerant (R32)		kg/TCO ₂ Eq.	—	—	—	—	—	—	—
Operating range	Cool Min ~ Max	°C	-15 ~ +46	-15 ~ +46	-15 ~ +46	-15 ~ +46	-15 ~ +46	-15 ~ +46	-15 ~ +46
	Heat Min ~ Max	°C	-20 ~ +24	-20 ~ +24	-20 ~ +24	-20 ~ +24	-20 ~ +24	-20 ~ +24	-20 ~ +24

Accessories

CZ-RTC5B	Wired remote controller with Econavi button and datanavi
CZ-RWS3 + CZ-RWRC3	Wireless remote controller
CZ-RE2C2	Simplified remote controller
PAW-WTRAY	Tray for condenser water compatible with base ground support
PAW-GRDBSE20	Outdoor base ground support for noise and vibration absorption

Accessories

PAW-GRDSTD40	Outdoor elevation platform 400 x 900 x 400mm
CZ-56DAF2	Air Outlet Plenum S . .PF1E5B 36, 45 & 50
CZ-90DAF2	Air Outlet Plenum S . .PF1E5B 60 & 71
CZ-160DAF2	Air Outlet Plenum S . .PF1E5B 100, 125 & 140
CZ-DUMPA90MF2	Air Inlet Plenum S . .PF1E5B 60 & 71
CZ-DUMPA160MF2	Air Inlet Plenum S . .PF1E5B 100, 125 & 140



NEW PACi Elite High Static Pressure Hide Away Inverter+ • R32 GAS

Tentative data

			Three Phase			
			7,10 kW	10,00 kW	12,50 kW	14,00 kW
Kit			KIT-71PF1ZH8	KIT-100PF1ZH8	KIT-125PF1ZH8	KIT-140PF1ZH8
Remote controller			CZ-RTC5B	CZ-RTC5B	CZ-RTC5B	CZ-RTC5B
Cooling capacity	kW		7,10	10,00	12,50	14,00
EER ¹⁾	W/W		3,92	4,18	3,56	3,32
SEER ²⁾	W/W		6,10 A++	5,80 A+	5,90	5,80
Pdesign	kW		7,10	10,00	12,50	14,00
Input power cooling	kW		1,81	2,39	3,51	4,22
Annual energy consumption ³⁾	kWh/a		—	—	—	—
Heating capacity	kW		8,00	11,20	14,00	16,00
Heating capacity at -7°C / -15°C ⁴⁾	kW		—	—	—	—
COP ¹⁾	W/W		3,85	4,31	3,48	3,60
SCOP ²⁾	W/W		4,10 A+	3,80 A	4,00	3,90
Pdesign at -10°C	kW		5,20	8,00	9,50	10,60
Input power heating	kW		2,08	2,60	4,02	4,44
Annual energy consumption ³⁾	kWh/a		—	—	—	—
Indoor unit			S-71PF1E5B	S-100PF1E5B	S-125PF1E5B	S-140PF1E5B
External static pressure ⁵⁾	Nominal (Min - Max)	Pa	70 (10 - 150)	100 (10 - 150)	100 (10 - 150)	100 (10 - 150)
Air volume	Hi / Med / Lo	m ³ /min	21,0 / 19,0 / 15,0	32,0 / 26,0 / 21,0	34,0 / 29,0 / 23,0	36,0 / 32,0 / 25,0
Sound pressure ⁵⁾	Hi / Med / Lo	dB(A)	35 / 32 / 26	38 / 34 / 31	39 / 35 / 32	40 / 36 / 33
Dimension	H x W x D	mm	290 x 1000 x 700	290 x 1400 x 700	290 x 1400 x 700	290 x 1400 x 700
Net weight	Indoor / Panel	kg	33	45	45	45
Outdoor unit			U-71PZH2E8	U-100PZH2E8	U-125PZH2E8	U-140PZH2E8
Power source		V	380 / 400 / 415	380 / 400 / 415	380 / 400 / 415	380 / 400 / 415
Recommended fuse		A	—	—	—	—
Current	Cool	A	—	—	—	—
	Heat	A	—	—	—	—
Air volume	Cool / Heat	m ³ /min	—	—	—	—
Sound pressure	Cool / Heat (Hi)	dB(A)	48 / 50	52 / 52	53 / 53	54 / 55
Sound power	Cool / Heat (Hi)	dB	65 / 67	69 / 69	70 / 70	71 / 71
Dimension	H x W x D	mm	996 x 940 x 340	1416 x 940 x 340	1416 x 940 x 340	1416 x 940 x 340
Net weight		kg	68	101	101	101
Piping connections	Liquid pipe	Inch (mm)	3/8 (9,52)	3/8 (9,52)	3/8 (9,52)	3/8 (9,52)
	Gas pipe	Inch (mm)	5/8 (15,88)	5/8 (15,88)	5/8 (15,88)	5/8 (15,88)
Pipe length range		m	5 ~ 50	5 ~ 75	5 ~ 75	5 ~ 75
Elevation difference (in/out) ⁶⁾		m	30	30	30	30
Pipe length for additional gas		m	30	30	30	30
Additional gas amount		g/m	—	—	—	—
Refrigerant (R32)		kg / TCO ₂ Eq.	—	—	—	—
Operating range	Cool Min ~ Max	°C	-15 ~ +46	-15 ~ +46	-15 ~ +46	-15 ~ +46
	Heat Min ~ Max	°C	-20 ~ +24	-20 ~ +24	-20 ~ +24	-20 ~ +24

1) EER and COP calculation is based in accordance to EN14511. 2) For models below 12 kW, the SEER and SCOP is calculated based on values of EU/626/2011. For models above 12 kW, the SEER and SCOP is calculated based on values of EU/2281/2016. 3) The annual energy consumption is calculated in accordance to EU/626/2011. 4) Heating capacity is calculated including defrost factor correction. At -10°C only for 10,00 kW. 5) Medium External static pressure setting from factory. 6) The sound pressure of the units shows the value measured at a position 1m in front of the main body and 1,5 m from the ground. The sound pressure is measured in accordance with Eurovent 6/C/006-97 specification. 7) When installing the outdoor unit at a higher position than the indoor unit. * Recommended fuse for the indoor 3A.



SEER and SCOP: For KIT-71PF1ZH5. INTERNET CONTROL: Optional.
Compatible with all Panasonic connectivity solutions. For detailed information go to the Control Systems section.

Rating Conditions: Cooling Indoor 27 °C DB / 19 °C WB, Cooling Outdoor 35 °C DB / 24 °C WB, Heating Indoor 20 °C DB, Heating Outdoor 7 °C DB / 6 °C WB. (DB: Dry Bulb; WB: Wet Bulb)
Specifications subject to change without notice. For detailed information about ErP / Energy Labelling, please visit our websites www.aircon.panasonic.eu or www.ptc.panasonic.eu.

R32

Kits 1x1



NEW
18

NEW PACi Standard High Static Pressure Hide Away Inverter+ • R32 GAS

Tentative data

			Single Phase				
			6,00 kW	7,10 kW	10,00 kW	12,50 kW	14,00 kW
Kit			KIT-60PF2Z5	KIT-71PF2Z5	KIT-100PF1Z5	KIT-125PF1Z5	KIT-140PF1Z5
Remote controller			CZ-RTC5B	CZ-RTC5B	CZ-RTC5B	CZ-RTC5B	CZ-RTC5B
Cooling capacity	Nominal (Min - Max)	kW	6,00	7,10	10,00 (3,00 - 11,50)	12,50 (3,20 - 13,50)	14,00 (3,30 - 15,00)
EER ¹⁾	Nominal (Min - Max)	W/W	3,49	2,87	3,66 (5,36 - 2,81)	3,52 (5,33 - 2,80)	3,18 (5,32 - 2,70)
SEER ²⁾	W/W		5,50A	5,40A	5,60A+	5,56	5,38
Pdesign		kW	6,00	7,10	10,00	12,50	14,00
Input power cooling	Nominal (Min - Max)	kW	1,72	2,47	2,73 (0,56 - 4,09)	3,55 (0,60 - 4,82)	4,40 (0,62 - 5,56)
Annual energy consumption ³⁾		kWh/a	—	—	625	787	911
Heating capacity	Nominal (Min - Max)	kW	6,00	7,10	10,00 (3,00 - 14,00)	12,50 (3,30 - 15,00)	14,00 (3,40 - 16,00)
Heating capacity at -7°C / -15°C ⁴⁾		kW	—	—	— / —	11,00 / —	12,00 / —
COP ¹⁾	Nominal (Min - Max)	W/W	4,55	4,13	4,31 (5,36 - 3,51)	4,02 (5,50 - 3,45)	3,79 (5,48 - 3,13)
SCOP ²⁾	W/W		4,20A+	4,20A+	3,80A	3,61	3,54
Pdesign at -10°C		kW	6,00	6,00	10,00	12,50	13,60
Input power heating	Nominal (Min - Max)	kW	1,32	1,72	2,32 (0,56 - 3,99)	3,11 (0,60 - 4,35)	3,69 (0,62 - 5,12)
Annual energy consumption ³⁾		kWh/a	—	—	3684	4848	5379
Indoor unit			S-60PF1E5B	S-71PF1E5B	S-100PF1E5B	S-125PF1E5B	S-140PF1E5B
External static pressure ⁵⁾	Nominal (Min - Max)	Pa	70 (10 - 150)	70 (10 - 150)	100 (10 - 150)	100 (10 - 150)	100 (10 - 150)
Air volume	Hi / Med / Lo	m ³ /min	21,0/19,0/15,0	21,0/19,0/15,0	32/26/21	34/29/23	36/32/25
Moisture removal volume		L/h	3,4	4,2	6,0	7,9	9,0
Sound pressure ⁶⁾	Hi / Med / Lo	dB(A)	35/32/26	35/32/26	38/34/31	39/35/32	40/36/33
Sound power	Hi / Med / Lo	dB	57/54/48	57/54/48	60/56/53	61/57/54	62/58/55
Dimension	H x W x D	mm	290 x 1000 x 700	290 x 1000 x 700	290 x 1400 x 700	290 x 1400 x 700	290 x 1400 x 700
Net weight		kg	33	33	45	45	45
Outdoor unit			U-60PZ2E5	U-71PZ2E5	U-100PZ2E5	U-125PZ2E5	U-140PZ2E5
Power source		V	220/230/240	220/230/240	220/230/240	220/230/240	220/230/240
Current	Cool	A	—	—	12,10/11,60/11,10	16,10/15,50/14,80	20,20/19,30/18,60
	Heat	A	—	—	10,10/9,70/9,30	14,00/13,40/12,90	16,80/16,00/15,30
Air volume	Cool / Heat	m ³ /min	—	—	76/70	86/78	89/83
Sound pressure	Cool / Heat (Hi)	dB(A)	46/48	49/49	52/52	55/55	56/56
Sound power	Cool / Heat (Hi)	dB	65/68	69/69	70/70	73/73	74/74
Dimension	H x W x D	mm	695 x 875 x 320	695 x 875 x 320	996 x 980 x 370	996 x 980 x 370	996 x 980 x 370
Net weight		kg	49	49	90	94	94
Piping connections	Liquid pipe	Inch (mm)	3/8 (9,52)	3/8 (9,52)	3/8 (9,52)	3/8 (9,52)	3/8 (9,52)
	Gas pipe	Inch (mm)	5/8 (15,88)	5/8 (15,88)	5/8 (15,88)	5/8 (15,88)	5/8 (15,88)
Pipe length range		m	3~40	3~40	5~50	5~50	5~50
Elevation difference (in/out) ⁷⁾		m	30	30	30	30	30
Pipe length for additional gas		m	30	30	30	30	30
Additional gas amount		g/m	—	—	45	45	45
Refrigerant (R32)		kg/TCO ₂ Eq.	—	—	2,60/1,755	2,98/2,0115	2,98/2,0115
Operating range	Cool Min ~ Max	°C	-10 ~ +43	-10 ~ +43	-10 ~ +43	-10 ~ +43	-10 ~ +43
	Heat Min ~ Max	°C	-15 ~ +24	-15 ~ +24	-15 ~ +24	-15 ~ +24	-15 ~ +24

Accessories

CZ-RTC5B	Wired remote controller with Econavi button and datanavi
CZ-RWS3 + CZ-RWRC3	Wireless remote controller
CZ-RE2C2	Simplified remote controller
PAW-WTRAY	Tray for condenser water compatible with base ground support
PAW-GRDBSE20	Outdoor base ground support for noise and vibration absorption

Accessories

PAW-GRDSTD40	Outdoor elevation platform 400 x 900 x 400mm
CZ-56DAF2	Air Outlet Plenum S...PF1E5B 36, 45 & 50
CZ-90DAF2	Air Outlet Plenum S...PF1E5B 60 & 71
CZ-160DAF2	Air Outlet Plenum S...PF1E5B 100, 125 & 140
CZ-DUMPA90MF2	Air Inlet Plenum S...PF1E5B 60 & 71
CZ-DUMPA160MF2	Air Inlet Plenum S...PF1E5B 100, 125 & 140

Kits 1x1

R32



NEW PACi Standard High Static Pressure Hide Away Inverter+ • R32 GAS

Tentative data

			Three Phase		
			10,00 kW	12,50 kW	14,00 kW
Kit			KIT-100PF1Z8	KIT-125PF1Z8	KIT-140PF1Z8
Remote controller			CZ-RTC5B	CZ-RTC5B	CZ-RTC5B
Cooling capacity	Nominal (Min - Max)	kW	10,00 (3,00 - 11,50)	12,50 (3,20 - 13,50)	14,00 (3,30 - 15,00)
EER ¹⁾	Nominal (Min - Max)	W/W	3,66 (5,36 - 2,81)	3,52 (5,33 - 2,80)	3,18 (5,32 - 2,70)
SEER ²⁾		W/W	5,60 A+	5,54	5,37
Pdesign		kW	10,00	12,50	14,00
Input power cooling	Nominal (Min - Max)	kW	2,73 (0,56 - 4,09)	3,55 (0,60 - 4,82)	4,40 (0,62 - 5,56)
Annual energy consumption ³⁾		kWh/a	625	790	912
Heating capacity	Nominal (Min - Max)	kW	10,00 (3,00 - 14,00)	12,50 (3,30 - 15,00)	14,00 (3,40 - 16,00)
Heating capacity at -7°C / -15°C ⁴⁾		kW	— / —	11,00 / —	12,00 / —
COP ¹⁾	Nominal (Min - Max)	W/W	4,31 (5,36 - 3,51)	4,02 (5,50 - 3,45)	3,79 (5,48 - 3,13)
SCOP ²⁾		W/W	3,80 A	3,61	3,54
Pdesign at -10°C		kW	10,00	12,50	13,60
Input power heating	Nominal (Min - Max)	kW	2,32 (0,56 - 3,99)	3,11 (0,60 - 4,35)	3,69 (0,62 - 5,12)
Annual energy consumption ³⁾		kWh/a	3684	4848	5379
Indoor unit			S-100PF1E5B	S-125PF1E5B	S-140PF1E5B
External static pressure ⁵⁾	Nominal (Min - Max)	Pa	100 (10 - 150)	100 (10 - 150)	100 (10 - 150)
Air volume	Hi / Med / Lo	m ³ /min	32/26/21	34/29/23	36/32/25
Moisture removal volume		L/h	6,0	7,9	9,0
Sound pressure ⁶⁾	Hi / Med / Lo	dB(A)	38/34/31	39/35/32	40/36/33
Sound power	Hi / Med / Lo	dB	60/56/53	61/57/54	62/58/55
Dimension	H x W x D	mm	290 x 1400 x 700	290 x 1400 x 700	290 x 1400 x 700
Net weight		kg	45	45	45
Outdoor unit			U-100PZ2E8	U-125PZ2E8	U-140PZ2E8
Power source		V	380/400/415	380/400/415	380/400/415
Current	Cool	A	4,15/3,95/3,80	5,40/5,10/4,95	6,75/6,40/6,15
	Heat	A	3,45/3,30/3,20	4,70/4,45/4,30	5,60/5,30/5,15
Air volume	Cool / Heat	m ³ /min	76/70	86/78	89/83
Sound pressure	Cool / Heat (Hi)	dB(A)	52/52	55/55	56/56
Sound power	Cool / Heat (Hi)	dB	70/70	73/73	74/74
Dimension	H x W x D	mm	996 x 980 x 370	996 x 980 x 370	996 x 980 x 370
Net weight		kg	90	94	94
Piping connections	Liquid pipe	Inch (mm)	3/8 (9,52)	3/8 (9,52)	3/8 (9,52)
	Gas pipe	Inch (mm)	5/8 (15,88)	5/8 (15,88)	5/8 (15,88)
Pipe length range		m	5 - 50	5 - 50	5 - 50
Elevation difference (in/out) ⁷⁾		m	30	30	30
Pipe length for additional gas		m	30	30	30
Additional gas amount		g/m	45	45	45
Refrigerant (R32)		kg/TCO ₂ Eq.	2,60/1,755	2,98/2,0115	2,98/2,0115
Operating range	Cool Min ~ Max	°C	-10 ~ +43	-10 ~ +43	-10 ~ +43
	Heat Min ~ Max	°C	-15 ~ +24	-15 ~ +24	-15 ~ +24

1) EER and COP calculation is based in accordance to EN14511. 2) For models below 12 kW, the SEER and SCOP is calculated based on values of EU/626/2011. For models above 12 kW, the SEER and SCOP is calculated based on values of EU/2281/2016. 3) The annual energy consumption is calculated in accordance to EU/626/2011. 4) Heating capacity is calculated including defrost factor correction. At -10°C only for 10,00 kW. 5) Medium External static pressure setting from factory. 6) The sound pressure of the units shows the value measured of a position 1m in front of the main body and 1,5 m from the ground. The sound pressure is measured in accordance with Eurovent 6/C/006-97 specification. 7) When installing the outdoor unit at a higher position than the indoor unit.* Recommended fuse for the indoor 3A.



SEER: For KIT-100PF1Z5 and KIT-100PF1Z8. SCOP: For KIT-60PF2Z5 and KIT-71PF2Z5. INTERNET CONTROL: Optional. Compatible with all Panasonic connectivity solutions. For detailed information go to the Control Systems section.

Rating Conditions: Cooling Indoor 27 °C DB / 19 °C WB. Cooling Outdoor 35 °C DB / 24 °C WB. Heating Indoor 20 °C DB. Heating Outdoor 7 °C DB / 6 °C WB. (DB: Dry Bulb; WB: Wet Bulb) Specifications subject to change without notice. For detailed information about ErP / Energy Labelling, please visit our websites www.aircon.panasonic.eu or www.ptc.panasonic.eu.

R32

Kits 1x1



NEW PACi Elite Low Static Pressure Hide Away Inverter+ • R32 GAS

Tentative data

			Single Phase						
			3,60 kW	5,00 kW	6,00 kW	7,10 kW	10,00 kW	12,50 kW	14,00 kW
Kit			KIT-36PN1ZH5	KIT-50PN1ZH5	KIT-60PN1ZH5	KIT-71PN1ZH5	KIT-100PN1ZH5	KIT-125PN1ZH5	KIT-140PN1ZH5
Remote controller			CZ-RTC5B	CZ-RTC5B	CZ-RTC5B	CZ-RTC5B	CZ-RTC5B	CZ-RTC5B	CZ-RTC5B
Cooling capacity	kW		3,60	5,00	6,00	7,10	10,00	12,50	14,00
EER ¹⁾	W/W		3,85	3,35	3,40	3,40	3,95	3,35	3,15
SEER ²⁾	W/W		4,70 B	4,90 B	5,60 A	5,60 A	6,00 A+	5,90	5,80
Pdesign	kW		3,60	5,00	6,00	7,10	10,00	12,50	14,00
Input power cooling	kW		0,94	1,49	1,76	2,09	2,53	3,73	4,44
Annual energy consumption ³⁾	kWh/a		—	—	—	—	—	—	—
Heating capacity	kW		4,00	5,60	7,00	8,00	11,20	14,00	16,00
Heating capacity at -7°C / -15°C ⁴⁾	kW		—	—	—	—	—	—	—
COP ¹⁾	W/W		4,40	3,35	3,75	3,68	3,90	3,70	3,50
SCOP ²⁾	W/W		4,00 A+	4,00 A+	4,00 A+	4,00 A+	4,00 A+	3,90	3,80
Pdesign at -10°C	kW		3,60	3,80	5,60	5,20	8,00	9,50	10,60
Input power heating	kW		0,91	1,67	1,87	2,17	2,87	3,78	4,57
Annual energy consumption ³⁾	kWh/a		—	—	—	—	—	—	—
Indoor unit			U-36PN1E5B	U-50PN1E5B	U-60PN1E5B	U-71PN1E5B	U-100PN1E5B	U-125PN1E5B	U-140PN1E5B
External static pressure ⁵⁾ Nominal [Min - Max]	Pa		25(10 - 80)	25(10 - 80)	25(10 - 80)	25(10 - 80)	40(10 - 80)	50(10 - 80)	50(10 - 80)
Air volume	Hi / Med / Lo	m ³ /min	—	—	—	—	—	—	—
Sound pressure ⁵⁾	Hi / Med / Lo	dB(A)	35/33/30	36/34/30	38/36/31	38/36/31	39/37/32	40/38/33	41/39/34
Dimension	H x W x D	mm	250 x 780 x 650	250 x 780 x 650	250 x 1000 x 650	250 x 1000 x 650	250 x 1200 x 650	250 x 1200 x 650	250 x 1200 x 650
Net weight	Indoor / Panel	kg	29	29	32	32	41	41	41
Outdoor unit			S-36PZH2E5	S-50PZH2E5	S-60PZH2E5	S-71PZH2E5	S-100PZH2E5	S-125PZH2E5	S-140PZH2E5
Power source		V	220/230/240	220/230/240	220/230/240	220/230/240	220/230/240	220/230/240	220/230/240
Recommended fuse		A	—	—	—	—	—	—	—
Current	Cool	A	—	—	—	—	—	—	—
	Heat	A	—	—	—	—	—	—	—
Air volume	Cool / Heat	m ³ /min	—	—	—	—	—	—	—
Sound pressure	Cool / Heat [Hi]	dB(A)	45/46	46/48	46/49	48/50	52/52	53/53	54/55
Sound power	Cool / Heat [Hi]	dB	64/66	65/68	65/69	65/67	69/69	70/70	71/71
Dimension	H x W x D	mm	695 x 875 x 320	695 x 875 x 320	695 x 875 x 320	996 x 940 x 340	1416 x 940 x 340	1416 x 940 x 340	1416 x 940 x 340
Net weight		kg	49	49	49	68	101	101	101
Piping connections	Liquid pipe	Inch (mm)	1/4(6,35)	1/4(6,35)	3/8(9,52)	3/8(9,52)	3/8(9,52)	3/8(9,52)	3/8(9,52)
	Gas pipe	Inch (mm)	1/2(12,70)	1/2(12,70)	5/8(15,88)	5/8(15,88)	5/8(15,88)	5/8(15,88)	5/8(15,88)
Pipe length range		m	3 ~ 40	3 ~ 40	3 ~ 40	5 ~ 50	5 ~ 75	5 ~ 75	5 ~ 75
Elevation difference (in/out) ⁶⁾		m	30	30	30	30	30	30	30
Pipe length for additional gas		m	30	30	30	30	30	30	30
Additional gas amount		g/m	—	—	—	—	—	—	—
Refrigerant (R32)		kg/TCO ₂ Eq.	—	—	—	—	—	—	—
Operating range	Cool Min ~ Max	°C	-15 ~ +46	-15 ~ +46	-15 ~ +46	-15 ~ +46	-15 ~ +46	-15 ~ +46	-15 ~ +46
	Heat Min ~ Max	°C	-20 ~ +24	-20 ~ +24	-20 ~ +24	-20 ~ +24	-20 ~ +24	-20 ~ +24	-20 ~ +24

Accessories

CZ-RTC5B	Wired remote controller with Econavi button and datanavi
CZ-RWS3 + CZ-RWRC3	Wireless remote controller
CZ-RE2C2	Simplified remote controller
PAW-WTRAY	Tray for condenser water compatible with base ground support

Accessories

PAW-GRDBSE20	Outdoor base ground support for noise and vibration absorption
PAW-GRDSTD40	Outdoor elevation platform 400 x 900 x 400mm
PAW-WPH7	Wind protection shield for U-100/125/140PZH2E5/8
PAW-WPH9	Wind protection shield for U-71PZH2E5/8



NEW PACi Elite Low Static Pressure Hide Away Inverter+ • R32 GAS

Tentative data

			Three Phase			
			7,10 kW	10,00 kW	12,50 kW	14,00 kW
Kit			KIT-71PN1ZH8	KIT-100PN1ZH8	KIT-125PN1ZH8	KIT-140PN1ZH8
Remote controller			CZ-RTC5B	CZ-RTC5B	CZ-RTC5B	CZ-RTC5B
Cooling capacity	kW		7,10	10,00	12,50	14,00
EER ¹⁾	W/W		3,40	3,95	3,35	3,15
SEER ²⁾	W/W		5,40A+	5,80A+	5,80	5,70
Pdesign	kW		7,10	10,00	12,50	14,00
Input power cooling	kW		2,09	2,53	3,73	4,44
Annual energy consumption ³⁾	kWh/a		—	—	—	—
Heating capacity	kW		8,00	11,20	14,00	16,00
Heating capacity at -7°C / -15°C ⁴⁾	kW		—	—	—	—
COP ¹⁾	W/W		3,68	3,90	3,70	3,50
SCOP ²⁾	W/W		4,00A+	4,00A+	3,90	3,80
Pdesign at -10°C	kW		5,20	8,00	9,50	10,60
Input power heating	kW		2,17	2,87	3,78	4,57
Annual energy consumption ³⁾	kWh/a		—	—	—	—
Indoor unit			S-71PN1E5B	S-100PN1E5B	S-125PN1E5B	S-140PN1E5B
External static pressure ⁵⁾	Nominal (Min - Max)	Pa	25(10 - 80)	40(10 - 80)	50(10 - 80)	50(10 - 80)
Air volume	Hi / Med / Lo	m ³ /min	—	—	—	—
Sound pressure ⁵⁾	Hi / Med / Lo	dB(A)	38/36/31	39/37/32	40/38/33	41/39/34
Dimension	HxWxD	mm	250 x 1000 x 650	250 x 1200 x 650	250 x 1200 x 650	250 x 1200 x 650
Net weight	Indoor / Panel	kg	32	41	41	41
Outdoor unit			U-71PZH2E8	U-100PZH2E8	U-125PZH2E8	U-140PZH2E8
Power source		V	380/400/415	380/400/415	380/400/415	380/400/415
Recommended fuse		A	—	—	—	—
Current	Cool	A	—	—	—	—
	Heat	A	—	—	—	—
Air volume	Cool / Heat	m ³ /min	—	—	—	—
Sound pressure	Cool / Heat (Hi)	dB(A)	48/50	52/52	53/53	54/55
Sound power	Cool / Heat (Hi)	dB	65/67	69/69	70/70	71/71
Dimension	HxWxD	mm	996 x 940 x 340	1416 x 940 x 340	1416 x 940 x 340	1416 x 940 x 340
Net weight		kg	68	101	101	101
Piping connections	Liquid pipe	Inch (mm)	3/8(9,52)	3/8(9,52)	3/8(9,52)	3/8(9,52)
	Gas pipe	Inch (mm)	5/8(15,88)	5/8(15,88)	5/8(15,88)	5/8(15,88)
Pipe length range		m	5 ~ 50	5 ~ 75	5 ~ 75	5 ~ 75
Elevation difference (in/out) ⁶⁾		m	30	30	30	30
Pipe length for additional gas		m	30	30	30	30
Additional gas amount		g/m	—	—	—	—
Refrigerant (R32)		kg/TCO: Eq.	—	—	—	—
Operating range	Cool Min ~ Max	°C	-15 ~ +46	-15 ~ +46	-15 ~ +46	-15 ~ +46
	Heat Min ~ Max	°C	-20 ~ +24	-20 ~ +24	-20 ~ +24	-20 ~ +24

1) EER and COP calculation is based in accordance to EN14511. 2) For models below 12 kW, the SEER and SCOP is calculated based on values of EU/626/2011. For models above 12 kW, the SEER and SCOP is calculated based on values of EU/2281/2016. 3) The annual energy consumption is calculated in accordance to EU/626/2011. 4) Heating capacity is calculated including defrost factor correction. 5) Medium external static pressure setting from factory. 6) The sound pressure of the units shows the value measured of a position 1m in front of the main body and 1,5m from the ground. The sound pressure is measured in accordance with Eurovent 6/C/006-97 specification. 7) Add 100mm for piping port. 8) When installing the outdoor unit at a higher position than the indoor unit.* Recommended fuse for the indoor 3A.



SEER and SCOP: KIT-100PN1ZH5. INTERNET CONTROL: Optional.
Compatible with all Panasonic connectivity solutions. For detailed information go to the Control Systems section.

Rating Conditions: Cooling Indoor 27 °C DB / 19 °C WB, Cooling Outdoor 35 °C DB / 24 °C WB, Heating Indoor 20 °C DB, Heating Outdoor 7 °C DB / 6 °C WB. (DB: Dry Bulb; WB: Wet Bulb)
Specifications subject to change without notice. For detailed information about ErP / Energy Labelling, please visit our websites www.aircon.panasonic.eu or www.ptc.panasonic.eu.



NEW PACi Standard Low Static Pressure Hide Away Inverter+ • R32 GAS

Tentative data

			Single Phase				
			6,00 kW	7,10 kW	10,00 kW	12,50 kW	14,00 kW
Kit			KIT-60PN1Z5	KIT-71PN1Z5	KIT-100PN1Z5	KIT-125PN1Z5	KIT-140PN1Z5
Remote controller			CZ-RTC5B	CZ-RTC5B	CZ-RTC5B	CZ-RTC5B	CZ-RTC5B
Cooling capacity	kW		6,00	7,10	10,00	12,50	14,00
EER ¹⁾	W/W		3,20	2,95	3,10	3,00	2,90
SEER ²⁾	W/W		5,00 B	5,30 A	5,40 A	5,10	5,00
Pdesign	kW		6,00	7,10	10,00	12,50	14,00
Input power cooling	kW		1,88	2,41	3,23	4,17	4,83
Annual energy consumption ³⁾	kWh/a		—	—	—	—	—
Heating capacity	kW		6,00	7,10	10,00	12,50	14,00
Heating capacity at -7°C / -15°C ⁴⁾	kW		—	—	—	—	—
COP ¹⁾	W/W		3,80	3,60	3,70	3,60	3,55
SCOP ²⁾	W/W		4,00 A+	4,00 A+	3,90 A	3,60	3,40
Pdesign at -10°C	kW		5,60	5,60	7,60	12,50	14,00
Input power heating	kW		1,58	1,97	2,70	3,47	3,94
Annual energy consumption ³⁾	kWh/a		—	—	—	—	—
Indoor unit			S-60PN1E5B	S-71PN1E5B	S-100PN1E5B	S-125PN1E5B	S-140PN1E5B
External static pressure ⁵⁾	Nominal (Min - Max)	Pa	25(10 - 80)	25(10 - 80)	40(10 - 80)	50(10 - 80)	50(10 - 80)
Air volume	Hi / Med / Lo	m ³ /min	—	—	—	—	—
Sound pressure ⁶⁾	Hi / Med / Lo	dB(A)	38/36/31	38/36/31	39/37/32	40/38/33	41/39/34
Dimension	HxWxD	mm	250x1000x650	250x1000x650	250x1200x650	250x1200x650	250x1200x650
Net weight		kg	32	32	41	41	41
Outdoor unit			U-60PZ2E5	U-71PZ2E5	U-100PZ2E5	U-125PZ2E5	U-140PZ2E5
Power source		V	220/230/240	220/230/240	220/230/240	220/230/240	220/230/240
Current	Cool	A	—	—	12,10/11,60/11,10	16,10/15,50/14,80	20,20/19,30/18,60
	Heat	A	—	—	10,10/9,70/9,30	14,00/13,40/12,90	16,80/16,00/15,30
Air volume	Cool / Heat	m ³ /min	—	—	76/70	86/78	89/83
Sound pressure	Cool / Heat (Hi)	dB(A)	46/48	49/49	52/52	55/55	56/56
Sound power	Cool / Heat (Hi)	dB	65/68	69/69	70/70	73/73	74/74
Dimension	HxWxD	mm	695x875x320	695x875x320	996x980x370	996x980x370	996x980x370
Net weight		kg	49	49	90	94	94
Piping connections	Liquid pipe	Inch (mm)	3/8(9,52)	3/8(9,52)	3/8(9,52)	3/8(9,52)	3/8(9,52)
	Gas pipe	Inch (mm)	5/8(15,88)	5/8(15,88)	5/8(15,88)	5/8(15,88)	5/8(15,88)
Pipe length range		m	3 - 40	3 - 40	5 - 50	5 - 50	5 - 50
Elevation difference (in/out) ⁷⁾		m	30	30	30	30	30
Pipe length for additional gas		m	30	30	30	30	30
Additional gas amount		g/m	—	—	45	45	45
Refrigerant (R32)		kg/TCO ₂ Eq.	—	—	2,60/1,755	2,98/2,0115	2,98/2,0115
Operating range	Cool Min ~ Max	°C	-10 ~ +43	-10 ~ +43	-10 ~ +43	-10 ~ +43	-10 ~ +43
	Heat Min ~ Max	°C	-15 ~ +24	-15 ~ +24	-15 ~ +24	-15 ~ +24	-15 ~ +24

Accessories

CZ-RTC5B	Wired remote controller with Econavi button and datanavi
CZ-RWS3 + CZ-RWRC3	Wireless remote controller
CZ-RE2C2	Simplified remote controller
PAW-WTRAY	Tray for condenser water compatible with base ground support

Accessories

PAW-GRDBSE20	Outdoor base ground support for noise and vibration absorption
PAW-GRDSTD40	Outdoor elevation platform 400x900x400mm
PAW-WPH7	Wind protection shield for U-100/125/140PZH2E5/8
PAW-WPH9	Wind protection shield for U-71PZH2E5/8

Kits 1x1

R32



NEW PACi Standard Low Static Pressure Hide Away Inverter+ • R32 GAS

Tentative data

		Three Phase		
		10,00 kW	12,50 kW	14,00 kW
Kit		KIT-100PN1Z8	KIT-125PN1Z8	KIT-140PN1Z8
Remote controller		CZ-RTC5B	CZ-RTC5B	CZ-RTC5B
Cooling capacity	kW	10,00	12,50	14,00
EER ¹⁾	W/W	3,10	3,00	2,90
SEER ²⁾	W/W	5,30A	5,00	4,90
Pdesign	kW	10,00	12,50	14,00
Input power cooling	kW	3,23	4,17	4,83
Annual energy consumption ³⁾	kWh/a	—	—	—
Heating capacity	kW	10,00	12,50	14,00
Heating capacity at -7°C / -15°C ⁴⁾	kW	—	—	—
COP ¹⁾	W/W	3,70	3,60	3,55
SCOP ²⁾	W/W	3,90A	3,60	3,40
Pdesign at -10°C	kW	7,60	12,50	14,00
Input power heating	kW	2,70	3,47	3,94
Annual energy consumption ³⁾	kWh/a	—	—	—
Indoor unit		S-100PN1E5B	S-125PN1E5B	S-140PN1E5B
External static pressure ⁵⁾	Nominal (Min - Max) Pa	40(10 - 80)	50(10 - 80)	50(10 - 80)
Air volume	Hi / Med / Lo m ³ /min	—	—	—
Sound pressure ⁶⁾	Hi / Med / Lo dB(A)	39/37/32	40/38/33	41/39/34
Dimension	H x W x D mm	250 x 1200 x 650	250 x 1200 x 650	250 x 1200 x 650
Net weight	kg	41	41	41
Outdoor unit		U-100PZ2E8	U-125PZ2E8	U-140PZ2E8
Power source	V	380/400/415	380/400/415	380/400/415
Current	Cool A	4,15/3,95/3,80	5,40/5,10/4,95	6,75/6,40/6,15
	Heat A	3,45/3,30/3,20	4,70/4,45/4,30	5,60/5,30/5,15
Air volume	Cool / Heat m ³ /min	76/70	86/78	89/83
Sound pressure	Cool / Heat (Hi) dB(A)	52/52	55/55	56/56
Sound power	Cool / Heat (Hi) dB	70/70	73/73	74/74
Dimension	H x W x D mm	996 x 980 x 370	996 x 980 x 370	996 x 980 x 370
Net weight	kg	90	94	94
Piping connections	Liquid pipe Inch (mm)	3/8(9,52)	3/8(9,52)	3/8(9,52)
	Gas pipe Inch (mm)	5/8(15,88)	5/8(15,88)	5/8(15,88)
Pipe length range	m	5 - 50	5 - 50	5 - 50
Elevation difference (in/out) ⁷⁾	m	30	30	30
Pipe length for additional gas	m	30	30	30
Additional gas amount	g/m	45	45	45
Refrigerant (R32)	kg / TCO ₂ Eq.	2,60 / 1,755	2,98 / 2,0115	2,98 / 2,0115
Operating range	Cool Min ~ Max °C	-10 ~ +43	-10 ~ +43	-10 ~ +43
	Heat Min ~ Max °C	-15 ~ +24	-15 ~ +24	-15 ~ +24

1) EER and COP calculation is based in accordance to EN14511. 2) For models below 12 kW, the SEER and SCOP is calculated based on values of EU/626/2011. For models above 12 kW, the SEER and SCOP is calculated based on values of EU/2281/2016. 3) The annual energy consumption is calculated in accordance to EU/626/2011. 4) Heating capacity is calculated including defrost factor correction. 5) Medium external static pressure setting from factory. 6) The sound pressure of the units shows the value measured of a position 1m in front of the main body and 1,5m from the ground. The sound pressure is measured in accordance with Eurovent 6/C/006-97 specification. 7) Add 100mm for piping port. 8) When installing the outdoor unit at a higher position than the indoor unit.* Recommended fuse for the indoor 3A.



SEER: For KIT-100PN1Z5. SCOP: For KIT-60PN1Z5 and KIT-71PN1Z5. INTERNET CONTROL: Optional. Compatible with all Panasonic connectivity solutions. For detailed information go to the Control Systems section.

Rating Conditions: Cooling Indoor 27 °C DB / 19 °C WB. Cooling Outdoor 35 °C DB / 24 °C WB. Heating Indoor 20 °C DB. Heating Outdoor 7 °C DB / 6 °C WB. (DB: Dry Bulb; WB: Wet Bulb) Specifications subject to change without notice. For detailed information about ErP / Energy Labelling, please visit our websites www.aircon.panasonic.eu or www.ptc.panasonic.eu.

SOLUTIONS FOR INDUSTRIES, WAREHOUSES, GARAGES AND BUS DEPOTS

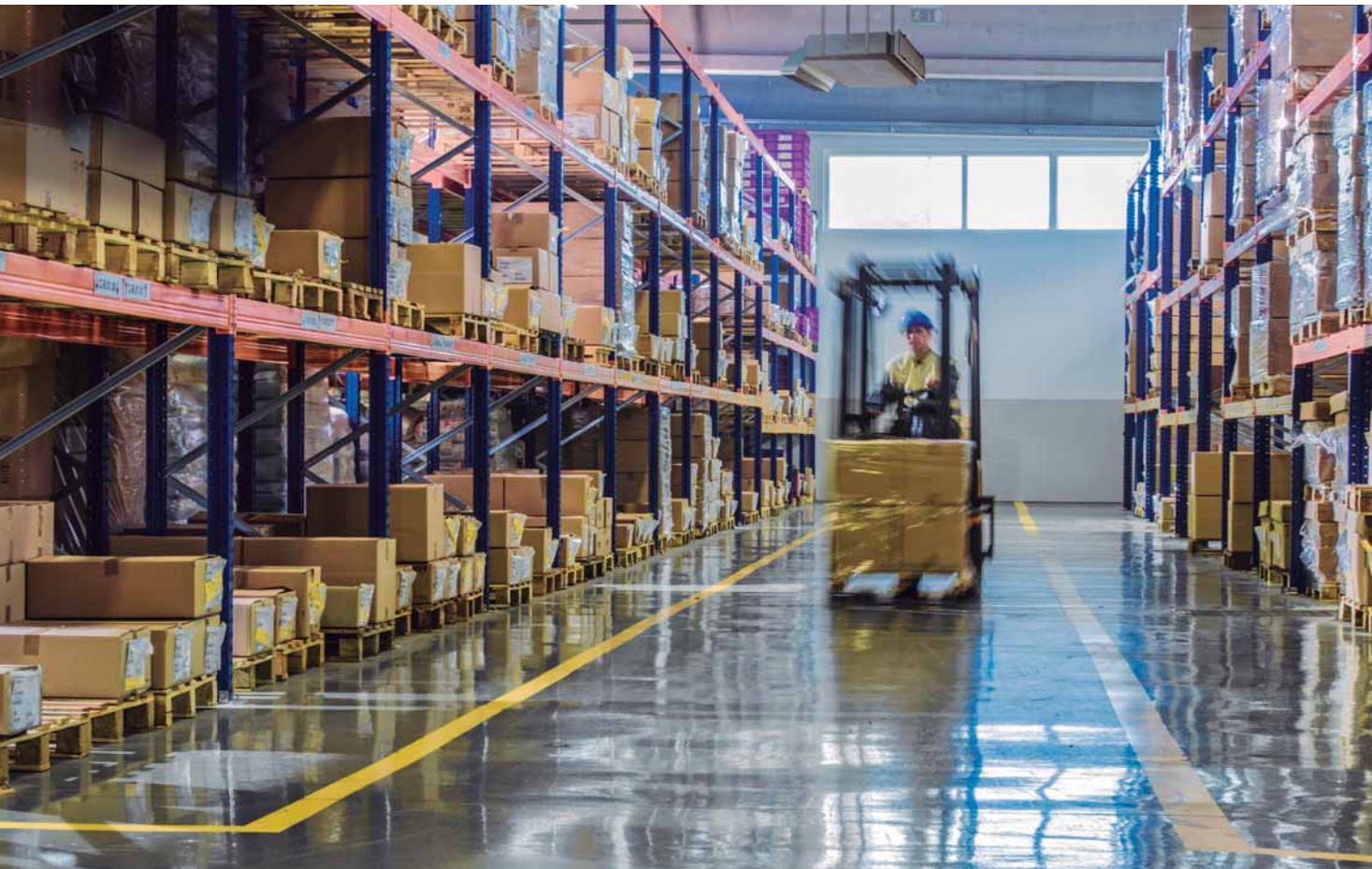

Solutions for industries, warehouses, garages and bus depots Ducted indoor unit 20-31,50 kW

- Downward air flow rate of up to 8m
- Super quiet (from 38 to 43dB)
- EC fan motor for extremely high efficiency
- Outlet plenum angled through 90 degrees (PAW-DUMPAPE2ME2)
- Air flow direction louvres help to disperse the air as required
- Easy to install

Panasonic has developed the new 90 degree plenum, which can be adjusted to S-200PE2E5 and S-250PE2E5 in order to drive the air downward and efficiently heat large premises.

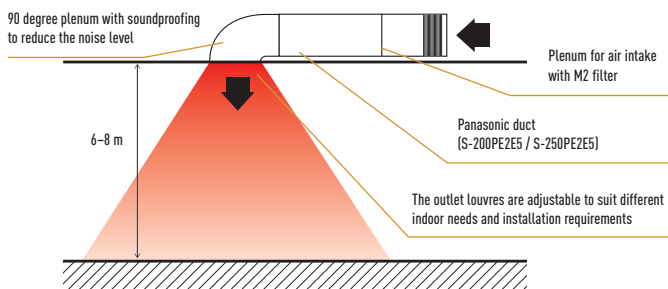

- Inverter system with high efficiency
- Maximum pipe length 100m (more than 40 % longer than other split systems)
- Multifunctional remote control with integrated temperature adjustment
- Fresh air supply (possible to connect fresh air from ventilation system)

System example.

An inspection door (minimum 450 x 450 mm) is required on the underside of the indoor unit. Air diffuser (to be acquired locally).



Plenum angled through 90 degrees

S-200PE2E5 / S-250PE2E5

Outlet plenum with M1 filter

Energy efficiency and ecology.

- Inverter system with highest efficiency
- Environmentally friendly refrigerant R410A

Comfort.

- Cooling operation even at low outdoor temperatures (down to -15 °C)
- Heating operation even at low outdoor temperatures
- For the thermal probe there is a placement choice of either the indoor unit or the wired remote control

Easy to use.

- Weekly program (six settings per day and 42 per week)
- Selection of wired, wireless and simplified remote control devices

Easy installation and maintenance service.

- Units with high static pressure are ideal for large premises

Big PACi Kits

R410A



Big PACi High Static Pressure Hide Away 20,00-25,00 kW Inverter+ • R410A GAS

			Three Phase	
			20,00 kW	25,00 kW
Kit			KIT-200PE2E5D	KIT-250PE2E5D
Remote controller			CZ-RTC5B	CZ-RTC5B
Cooling capacity	Nominal (Min - Max)	kW	19,50(5,40 - 22,40)	25,00(6,30 - 28,00)
EER ¹⁾		W/W	3,11	2,91
SEER ²⁾		W/W	5,34	4,83
Pdesign		kW	19,50	25,00
Input power cooling		kW	5,97	8,04
Heating capacity	Nominal (Min - Max)	kW	22,40(5,60 - 25,00)	28,00(7,10 - 31,50)
Heating capacity at -7°C / -15°C ³⁾		kW	20,00/17,00	25,20/21,42
COP ¹⁾		W/W	3,54	3,64
SCOP ²⁾		W/W	3,55	3,56
Pdesign at -10°C		kW	17,00	20,00
Input power heating		kW	6,02	7,14
Indoor unit			S-200PE2E5	S-250PE2E5
Power source		V / ph / Hz	220 - 230 - 240/1/50	220 - 230 - 240/1/50
External static pressure at shipment (with booster cable) ⁴⁾		Pa	60 - 140 - 270	72 - 140 - 270
Air volume	Hi / Med / Lo	m ³ /min	56/51/44	72/63/53
Sound pressure ⁵⁾	Hi / Med / Lo	dB(A)	43/41/38	47/45/42
Dimension	H x W x D	mm	479 x 1453 x 1205	479 x 1453 x 1205
Net weight		kg	100	104
Outdoor unit			U-200PE2E8A	U-250PE2E8A
Power source		V / ph / Hz	380 - 400 - 415/3/50	380 - 400 - 415/3/50
Recommended fuse		A	15	20
Air volume	Cool / Heat	m ³ /min	164	160
Sound pressure ⁵⁾	Cool / Heat (Hi)	dB(A)	60/62	61/63
Dimension ⁶⁾	H x W x D	mm	1500 x 980 x 370	1500 x 980 x 370
Net weight		kg	127	138
Piping connections	Liquid pipe	Inch (mm)	3/8(9,52)	1/2(12,70)
	Gas pipe	Inch (mm)	1(25,40)	1(25,40)
Pipe length range		m	5 - 120	5 - 120
Elevation difference (in/out) ⁷⁾		m	30	30
Pipe length for additional gas		m	30	30
Additional gas amount		g/m	50	80
Refrigerant (R410A)		kg/TCO ₂ Eq.	5,60/11,6928	6,40/13,3632
Operating range	Cool Min - Max	°C	-15 - +46	-15 - +46
	Heat Min - Max	°C	-20 - +24	-20 - +24

Accessories

CZ-RTC5B	Wired remote controller with Econavi button and datanavi
CZ-RWS3 + CZ-RWRC3	Wireless remote controller
CZ-RE2C2	Simplified remote controller
PAW-GRDSTD40	Outdoor elevation platform 400 x 900 x 400 mm

Accessories

CZ-TREMIESPW706	Air Outlet Plenum (suitable for rigid + flexible duct) for S-250PE2E5
CZ-TREMIESPW705	Air Outlet Plenum (suitable for rigid + flexible duct) for S-200PE2E5

1) EER and COP calculation is based in accordance to EN14511. 2) For models below 12 kW, the SEER and SCOP is calculated based on values of EU/626/2011. For models above 12 kW, the SEER and SCOP is calculated based on values of EU/2281/2016. 3) Heating capacity is calculated including defrost factor correction. 4) Medium external static pressure setting from factory. 5) The sound pressure of the units shows the value measured at a position 1 m in front of the main body and 1,5 m from the ground. The sound pressure is measured in accordance with Eurovent 6/C/006-97 specification. 6) Add 100 mm for indoor unit or 70 mm for outdoor unit for piping port. 7) When installing the outdoor unit at a higher position than the indoor unit. * No filter included.



INTERNET CONTROL: Optional.
Compatible with all Panasonic connectivity solutions. For detailed information go to the Control Systems section.

Rating Conditions: Cooling Indoor 27 °C DB / 19 °C WB, Cooling Outdoor 35 °C DB / 24 °C WB, Heating Indoor 20 °C DB, Heating Outdoor 7 °C DB / 6 °C WB. (DB: Dry Bulb; WB: Wet Bulb)
Specifications subject to change without notice. For detailed information about ErP / Energy Labelling, please visit our websites www.aircon.panasonic.eu or www.ptc.panasonic.eu.

ECONAVI SENSOR



Saving Energy for Offices with the Econavi sensor

Providing outstanding energy-saving performance, Panasonic's Inverter System can be connected to Econavi to detect when energy is being wasted. Econavi senses the presence or absence of people and the level of activity in each area of an office. When unnecessary heating or cooling is detected, indoor units are individually controlled to match office conditions for energy-saving operation.

Detection of the level of activity enables precise power saving.

Presence or absence of people at their desks and the level of activity in the office are detected in real time. Set temperature is automatically adjusted to optimise the lower power consumption.



Econavi Sensor.
CZ-CENSC1



Remote Econavi sensor allows optimum energy operation.

Pillars, walls, cabinets and other fittings obstruct the sensor, reducing the area of detection and lowering the energy-saving effect. Taking into consideration blind spots, Panasonic enables the optimum layout for sensors in any office.



In the morning.
Thorough cooling when there is a high level of activity.

In the afternoon.
Reduced cooling when there are fewer people.

At night.
Automatic Thermo Off depending on conditions at the end of the day.

REMOTE CONTROLLER WITH ECONAVI AND DATANAVI



Easy to use, attractive, clear design, with new demand control functions and energy consumption display! This useful feature makes this remote controller unique!

Key Functions

- Easy setup of the timer and settings of the indoor unit
- Energy consumption display
- Limitation of the energy consumption (Demand control) by timer.

Backup control by using CZ-RTC5B

Group wiring of 2 systems of PACi can do auto individual control.

- Rotation operation
- Backup operation
- Support operation

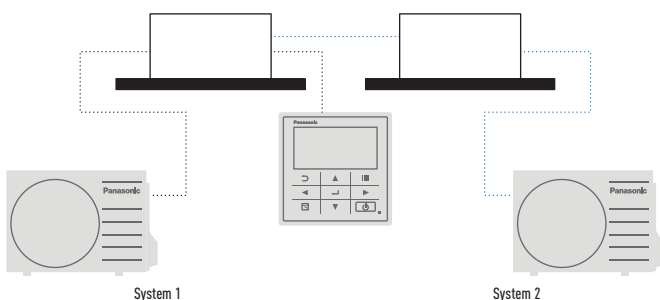

Basic function (Operation display & indication)

All functions are easily available on the remote controller.

1. Name of the room (Max.16 characters)
2. Time & Day of the week
3. Mode: Hot / Cool / Dry / Fan Auto
4. Status: Heating stand-by / Defrost operation / Stand-by (ECO G system)
5. Set temperature
6. Flap setting
7. Fan speed: H / M / L / Auto

Functions available on the CZ-RTC5B

Control item	Controllability	Indoor Units	
		PACi Standard	PACi Elite
Basic Operation	Operation, Mode, Temperature setting, Airflow volume, Airflow direction	✓	✓
	Time display	✓	✓
Timer function	Easy ON/OFF timer	✓	✓
	Weekly Program timer	✓	✓
	Outing function	✓	✓
	Temperature auto return	✓	✓
Energy saving	Temperature setting range limitation	✓	✓
	OFF remind	✓	✓
	Energy saving mode	✓	✓
Maintenance	Schedule demand control	—	✓
	Energy monitoring - R32	✓	✓
	System failure information	✓	✓
	Service contact registration	✓	✓
	Filter sign (rest time display) & Reset	✓	✓
	Auto-address, Test run	✓	✓
	Sensor value monitor	✓	✓
	Simple / Detail setting mode	✓	✓
	Key lock	✓	✓
	Ventilation fan control	✓	✓
Others	Display contrast adjustment	✓	✓
	Remote controller sensor	✓	✓
	Quiet operation mode	—	✓
	Prohibit setting control from Central controller	✓	✓

All specifications subject to change without notice.

PACi Elite Outdoor Units • R32 GAS

PACi Standard Outdoor Units • R32 GAS



NEW PACi Elite Outdoor Units • R32 GAS¹

			7,10 kW	10,00 kW	12,50 kW	14,00 kW
Outdoor unit Single Phase			U-71PZH2E5	U-100PZH2E5	U-125PZH2E5	U-140PZH2E5
Outdoor unit Three Phase			U-71PZH2E8	U-100PZH2E8	U-125PZH2E8	U-140PZH2E8
Cooling capacity	Nominal (Min - Max)	kW				
Heating capacity	Nominal (Min - Max)	kW				
Power source	Single Phase	V	220/230/240	220/230/240	220/230/240	220/230/240
	Three Phase	V	380/400/415	380/400/415	380/400/415	380/400/415
Connection indoor / outdoor		mm ²	—	—	—	—
Air volume	Cool / Heat	m ³ /min	—	—	—	—
Sound pressure	Cool / Heat (Hi)	dB(A)	48/50	52/52	53/53	54/55
Sound power	Cool / Heat (Hi)	dB	65/67	69/69	70/70	71/71
Dimension	HxWxD	mm	996 x 940 x 340	1416 x 940 x 340	1416 x 940 x 340	1416 x 940 x 340
Net weight		kg	68	101	101	101
Piping connections	Liquid pipe	Inch (mm)	3/8 (9,52)	3/8 (9,52)	3/8 (9,52)	3/8 (9,52)
	Gas pipe	Inch (mm)	5/8 (15,88)	5/8 (15,88)	5/8 (15,88)	5/8 (15,88)
Pipe length range	Min ~ Max	m	5 ~ 50	5 ~ 75	5 ~ 75	5 ~ 75
Elevation difference (in/out)	Max	m	30	30	30	30
Refrigerant (R32)		kg/TCO ₂ Eq.	—	—	—	—
Operating range	Cool Min ~ Max	°C	-15 ~ +46	-15 ~ +46	-15 ~ +46	-15 ~ +46
	Heat Min ~ Max	°C	-20 ~ +24	-20 ~ +24	-20 ~ +24	-20 ~ +24

1) These models will be available in Winter 2018.

NEW PACi Standard Outdoor Units • R32 GAS

			7,10 kW	10,00 kW	12,50 kW	14,00 kW
Outdoor unit Single Phase			U-71PZ2E5	U-100PZ2E5	U-125PZ2E5	U-140PZ2E5
Outdoor unit Three Phase			—	U-100PZ2E8	U-125PZ2E8	U-140PZ2E8
Cooling capacity	Nominal (Min - Max)	kW	7,10	10,00 (3,00 - 11,50)	12,50 (3,20 - 13,50)	14,00 (3,30 - 15,00)
Heating capacity	Nominal (Min - Max)	kW	7,10	10,00 (3,00 - 14,00)	12,50 (3,30 - 15,00)	14,00 (3,40 - 16,00)
Power source	Single Phase	V	220/230/240	220/230/240	220/230/240	220/230/240
	Three Phase	V	—	380/400/415	380/400/415	380/415
Connection indoor / outdoor		mm ²	—	—	—	—
Air volume	Cool / Heat	m ³ /min	—	76,00/70,00	86,00/78,00	89,00/83,00
Sound pressure	Cool / Heat (Hi)	dB(A)	49 / 49	52/52	55/55	56/56
Sound power	Cool / Heat (Hi)	dB	69 / 69	70/70	73/73	74/74
Dimension	HxWxD	mm	695 x 875 x 320	996 x 980 x 370	996 x 980 x 370	996 x 980 x 370
Net weight		kg	49	90	94	94
Piping connections	Liquid pipe	Inch (mm)	3/8 (9,52)	3/8 (9,52)	3/8 (9,52)	3/8 (9,52)
	Gas pipe	Inch (mm)	5/8 (15,88)	5/8 (15,88)	5/8 (15,88)	5/8 (15,88)
Pipe length range	Min ~ Max	m	3 ~ 40	5 ~ 50	5 ~ 50	5 ~ 50
Elevation difference (in/out)	Max	m	30	30	30	30
Refrigerant (R32)		kg/TCO ₂ Eq.	—	2,60 / 1,755	3,00 / 2,025	3,00 / 2,025
Operating range	Cool Min ~ Max	°C	-10 ~ +43	-10 ~ +43	-10 ~ +43	-10 ~ +43
	Heat Min ~ Max	°C	-15 ~ +24	-15 ~ +24	-15 ~ +24	-15 ~ +24

PACi Single, Twin, Triple and Double-Twin System

R32



NEW Wall	Indoor	Cooling capacity	Heating capacity	Dimension	Sound pressure	Air volume
				HxWxD	Hi / Med / Lo	Hi / Med / Lo
				mm	dB(A)	m³/min
3,60 kW	S-36PK2E5B	3,60	4,20	302x1120x236	35/31/27	11,00/9,50/7,50
4,50 kW	S-45PK2E5B	4,50	5,20	302x1120x236	38/34/30	12,00/10,50/8,50
5,00 kW	S-50PK2E5B	5,00	5,60	302x1120x236	40/36/32	14,00/12,00/10,50
6,00 kW	S-60PK2E5B	6,00	7,00	302x1120x236	47/44/40	18,00/14,50/11,50
7,10 kW	S-71PK2E5B	7,10	8,00	302x1120x236	47/44/40	18,00/14,50/11,50
10,00 kW	S-100PK2E5B	10,00	11,20	302x1120x236	47/44/40	19,00/16,50/13,00

4 Way 60x60 Cassette	Indoor	Panel	Cooling capacity	Heating capacity	Dimension: Indoor / CZ-KPY3AW / CZ-KPY3BW	Sound pressure	Air volume
					HxWxD	Hi / Med / Lo	Hi / Lo
					mm	dB(A)	m³/min
3,60 kW	S-36PY2E5B	CZ-KPY3AW/CZ-KPY3BW	3,60	4,20	288x583x583 / 31x700x700 / 31x625x625	36/32/26	9,70/9,90
4,50 kW	S-45PY2E5B	CZ-KPY3AW/CZ-KPY3BW	4,50	5,20	288x583x583 / 31x700x700 / 31x625x625	38/34/28	10,00/10,30
5,00 kW	S-50PY2E5B	CZ-KPY3AW/CZ-KPY3BW	5,00	5,60	288x583x583 / 31x700x700 / 31x625x625	40/37/33	11,10/11,10

4 Way 90x90 Cassette	Indoor	Panel	Cooling capacity	Heating capacity	Dimension Indoor	Dimension Panel	Sound pressure	Air volume
					HxWxD	HxWxD	Hi / Med / Lo	Hi / Med / Lo
					mm	mm	dB(A)	m³/min
3,60 kW	S-36PU2E5B	CZ-KPU3/CZ-KPU3A	3,60	4,20	256x840x840	33,5x950x950	30/28/27	14,50/13,00/11,50
4,50 kW	S-45PU2E5B	CZ-KPU3/CZ-KPU3A	4,50	5,20	256x840x840	33,5x950x950	31/28/27	15,50/13,00/11,50
5,00 kW	S-50PU2E5B	CZ-KPU3/CZ-KPU3A	5,00	5,60	256x840x840	33,5x950x950	32/29/27	16,50/13,50/11,50
6,00 kW	S-60PU2E5B	CZ-KPU3/CZ-KPU3A	6,00	7,00	256x840x840	33,5x950x950	38/31/28	21,00/16,00/13,00
7,10 kW	S-71PU2E5B	CZ-KPU3/CZ-KPU3A	7,10	8,00	256x840x840	33,5x950x950	37/31/28	22,00/16,00/13,00
10,00 kW	S-100PU2E5B	CZ-KPU3/CZ-KPU3A	10,00	11,20	319x840x840	33,5x950x950	45/38/32	36,00/26,00/18,00
12,50 kW	S-125PU2E5B	CZ-KPU3/CZ-KPU3A	12,50	14,00	319x840x840	33,5x950x950	46/39/33	37,00/27,00/19,00
14,00 kW	S-140PU2E5B	CZ-KPU3/CZ-KPU3A	14,00	14,00	319x840x840	33,5x950x950	47/40/34	38,00/29,00/20,00

Ceiling	Indoor	Cooling capacity	Heating capacity	Dimension	Sound pressure	Air volume
				HxWxD	Hi / Med / Lo	Hi / Med / Lo
				mm	dB(A)	m³/min
3,60 kW	S-36PT2E5B	3,60	4,20	235x960x690	35/32/30	14,00/12,00/10,50
4,50 kW	S-45PT2E5B	4,50	5,20	235x960x690	38/33/30	15,00/12,50/10,50
5,00 kW	S-50PT2E5B	5,00	5,60	235x960x690	38/33/30	15,00/12,50/10,50
6,00 kW	S-60PT2E5B	6,00	7,00	235x1275x690	39/36/33	20,00/17,00/14,50
7,10 kW	S-71PT2E5B	7,10	8,00	235x1275x690	39/36/33	21,00/18,00/15,50
10,00 kW	S-100PT2E5B	10,00	11,20	235x1590x690	42/38/35	30,00/25,00/23,00
12,50 kW	S-125PT2E5B	12,50	14,00	235x1590x690	45/40/37	34,00/28,00/24,00
14,00 kW	S-140PT2E5B	14,00	14,00	235x1590x690	47/41/37	35,00/29,00/25,00

High Static Pressure Hide Away	Indoor	Cooling capacity	Heating capacity	Dimension	External static pressure	Sound pressure	Air volume
				HxWxD	Hi / Med / Lo	Hi / Med / Lo	Hi / Med / Lo
				mm	Pa	dB(A)	m³/min
3,60 kW	S-36PF1E5B	3,60	4,20	290x800x700	150/70/10	33/29/25	14,00/13,00/10,00
4,50 kW	S-45PF1E5B	4,50	5,20	290x800x700	150/70/10	34/30/26	14,00/13,00/10,00
5,00 kW	S-50PF1E5B	5,00	5,60	290x800x700	150/70/10	34/30/26	16,00/15,00/12,00
6,00 kW	S-60PF1E5B	6,00	7,00	290x1000x700	150/70/10	35/32/26	21,00/19,00/15,00
7,10 kW	S-71PF1E5B	7,10	8,00	290x1000x700	150/70/10	35/32/26	21,00/19,00/15,00
10,00 kW	S-100PF1E5B	10,00	11,20	290x1400x700	150/100/10	38/34/31	32,00/26,00/21,00
12,50 kW	S-125PF1E5B	12,50	14,00	290x1400x700	150/100/10	39/35/32	34,00/29,00/23,00
14,00 kW	S-140PF1E5B	14,00	14,00	290x1400x700	150/100/10	40/36/33	36,00/32,00/25,00

Low Static Pressure Hide Away	Indoor	Cooling capacity	Heating capacity	Dimension	External static pressure	Sound pressure	Air volume
				HxWxD	Hi / Med / Lo	Hi / Med / Lo	Hi / Med / Lo
				mm	Pa	dB(A)	m³/min
3,60 kW	S-36PN1E5B	3,60	4,20	250x780x650	80/50/10	40/38/35	14,00/12,00/10,00
4,50 kW	S-45PN1E5B	4,50	5,20	250x780x650	80/50/10	41/39/35	16,00/13,00/11,00
5,00 kW	S-50PN1E5B	5,00	5,60	250x780x650	80/50/10	41/39/35	16,00/13,00/11,00
6,00 kW	S-60PN1E5B	6,00	7,00	250x1000x650	80/50/10	43/41/36	22,00/20,00/16,00
7,10 kW	S-71PN1E5B	7,10	8,00	250x1000x650	80/50/10	43/41/36	22,00/20,00/16,00
10,00 kW	S-100PN1E5B	10,00	11,20	250x1200x650	80/50/10	44/42/37	36,00/33,00/26,00
12,50 kW	S-125PN1E5B	12,50	14,00	250x1200x650	80/50/10	46/44/39	38,00/35,00/28,00
14,00 kW	S-140PN1E5B	14,00	14,00	250x1200x650	80/50/10	46/44/39	40,00/37,00/30,00

Rating Conditions: Cooling Indoor 27 °C DB / 19 °C WB, Cooling Outdoor 35 °C DB / 24 °C WB, Heating Indoor 20 °C DB, Heating Outdoor 7 °C DB / 6 °C WB, (DB: Dry Bulb; WB: Wet Bulb)
 Specifications subject to change without notice. For detailed information about ErP / Energy Labelling, please visit our websites www.aircon.panasonic.eu or www.ptc.panasonic.eu.

CONNECTION TO AIR HANDLING SYSTEM



With an AHU kit, the PACi/ECOi outdoor unit is connected to air handling units of 5-189 kW

With the new AHU kit it is easy to connect Panasonic PACi and VRF outdoor units to air handling units with a refrigeration circuit without water or glycol. The flexible connectivity options mean that a Panasonic AHU kit can easily integrate and interact with the overall control system. Applications: Hotels, offices, computer server rooms or other spacious buildings where there is a need to control air quality, humidity and fresh air.



3 types of AHU Kit: Deluxe, Medium and Light.

Model code	IP 65	0-10 V demand control*	Outdoor temperature shift compensation. Cold draft prevention
PACi	PAW-280PAH2	Yes	Yes
	PAW-280PAH2M	Yes	No
	PAW-280PAH2L	Yes	No
VRF	PAW-160MAH2 / PAW-280MAH2 / PAW-560MAH2	Yes	Yes
	PAW-160MAH2M / PAW-280MAH2M / PAW-560MAH2M	Yes	No
	PAW-160MAH2L / PAW-280MAH2L / PAW-560MAH2L	Yes	No

* With CZ-CAPBC2.

PAW-280PAH2M // PAW-160MAH2M // PAW-280MAH2M // PAW-560MAH2M

- The system is controlled by the intake air (or return air from the room) temperature as well as by the control function: Automatic/Cooling/Heating
- The temperature of the outgoing air is also checked, to prevent excessively high or low temperature during cooling operation or cold air dumping during heating operation (applies to VRF system)
- External control with thermostat
- Signal for frost protection, thermostat ON/OFF outputs
- External control with 0-10V signal
- Can be connected to an overall control system
Pay special attention to the electrical noise depending on the relevant system.
- The control signal to the fan from the AHU kit can be used to control the air flow rate (high/medium/low)
External relay.

Panasonic AHU kit, 5-189 kW connected to PACi or ECOi outdoor unit

Complete control box with each control device.

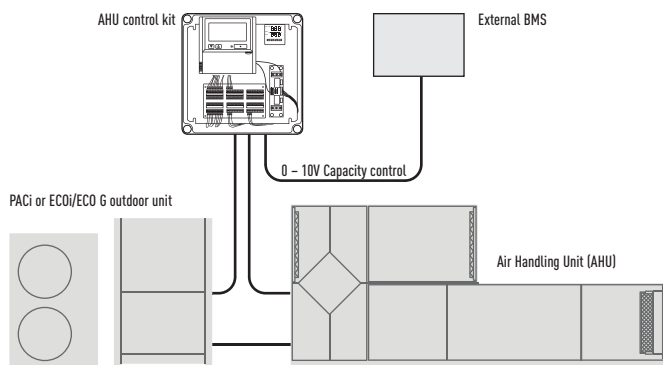

Demand control on the outdoor unit managed by external 0-10 V signal.

Technical focus

- Maximum capacity/system: 60 HP (168 kW)
- Maximum piping length: 100 m (120 m equivalent)
- Elevation difference (indoor unit / indoor unit): 4 m
- In/Out capacity ratio: 50~100 %
- Maximum indoor unit number: 3 units*
- Outdoor temperature range in heating: -20 ~ +15 °C
- Available temperature range for the suction air at AHU Kit:
cool: +18 ~ +32 °C / heat: +16 ~ +30 °C

* To be simultaneous operation controlled by one remote controller sensor.

Main parts in a mechanical ventilation system

The main parts in a mechanical ventilation system are the following:
Air handling unit (AHU), air ducts and components for air distribution.

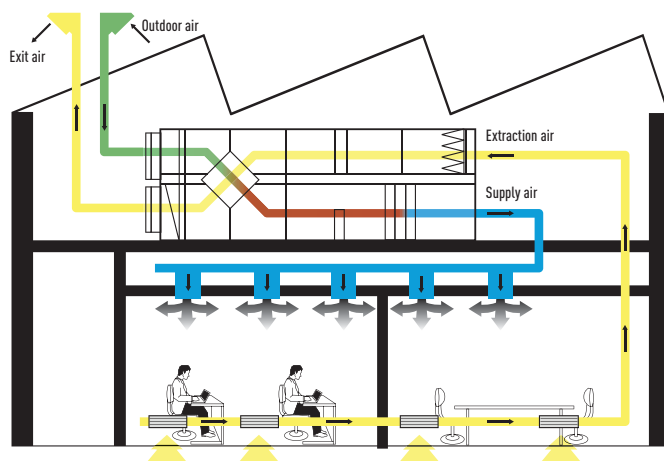

System and regulation. System summary of PACi and ECOi

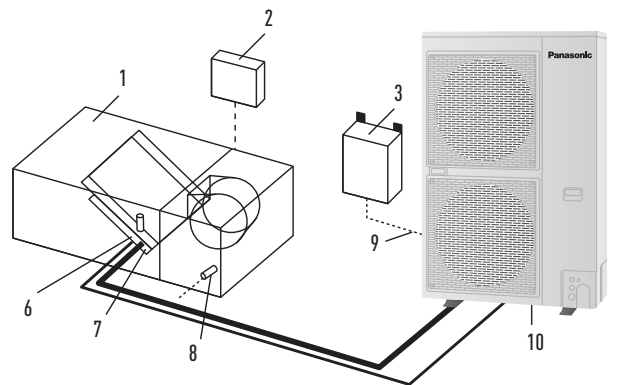

- 1. AHU (field supply)
- 2. Control device integrated in AHU kit
- 3. The AHU kit (complete)
- 4. Thermistor - supply air*
- 5. Electronic expansion valve*
- 6. Thermistor - gas pipe (E2 for PACi / E3 for ECOi)

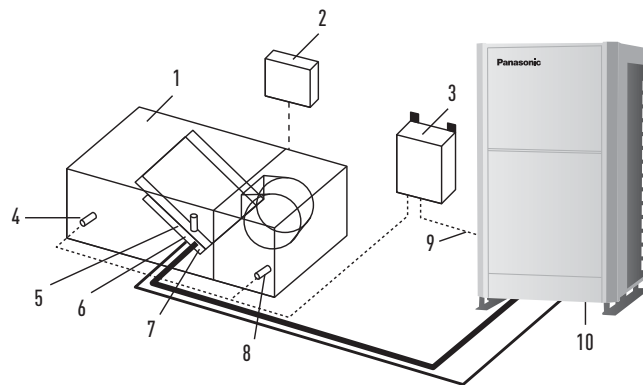

- 7. Thermistor - liquid pipe (E1)
 - 8. Thermistor - air intake
 - 9. Electric cables between units
 - 10. Outdoor unit
- * Component 4 and 5 are not included with PACi



AHU kit, 5-25 kW for PACi in heating and cooling operation

AHU kit PACi Elite	Cooling capacity	Heating capacity	Air flow rate, cooling operation	Dimensions	Pipe length	Difference in height at installation
	Nominal kW	Nominal kW	Min / Max m³/min	H x W x D mm	Min / Max m	Min / Max m
	PAW-280PAH2M	6 to 25	7 to 28	480 / 4,440	404 x 425 x 78	5 to 30
PAW-280PAH2M+PAW-280PAH2M	50,0	56,0	2,280 / 8,880	404 x 425 x 78	5 to 30	10

Air handling units / system combinations			Pipe length Min/Max	Height elevation	Airflow cooling Low / High		
Capacity cooling	Combination outdoor units	AHU-kit	m	m	m³/h	l/sec	m³/sec
3,60 kW	U-36PE2E5A	PAW-280PAH2M	5 to 30	10	430/650	119/180	
5,00 kW	U-50PE2E5	PAW-280PAH2M	5 to 30	10	480/780	133/217	
6,00 kW	U-60PE2E5A	PAW-280PAH2M	5 to 30	10	540/960	150/267	
7,50 kW	U-71PE1E5 / U-71PE1E8A	PAW-280PAH2M	5 to 30	10	720/1500	200/417	0,20/0,42
10,00 kW	U-100PE1E8A	PAW-280PAH2M	5 to 30	10	840/1980	233/550	0,23/0,55
12,50 kW	U-125PE1E8A	PAW-280PAH2M	5 to 30	10	1140/2100	317/583	0,32/0,58
14,00 kW	U-140PE1E8A	PAW-280PAH2M	5 to 30	10			
20,00 kW	U-200PE2E8A	PAW-280PAH2M	5 to 30	10	1680/3960	467/1100	0,47/1,10
25,00 kW	U-250PE2E8A	PAW-280PAH2M	5 to 30	10	2280/4440	633/1233	0,63/1,23
50,00 kW	U-250PE2E8A + U-250PE2E8A	PAW-280PAH2M + PAW-280PAH2M	5 to 30	10	2280/8880	633/2470	0,63/2,47

AHU Connection Kit



AHU kit.
PCB, power transformer, terminal block



Expansion valve



Thermistor x2
(Refrigerant: E1, E3)



Thermistor x2
(Air: Tf, Tb)



Remote control.
Wired remote control. Included

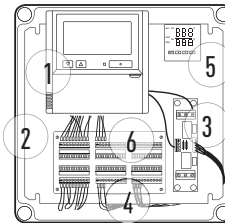

1. Remote control CZ-RTC4
2. New plastic IP 65 Box
3. PAW-T10 PCB for dry contact
4. 0-10V demand control PCB
5. Intelligent thermostat for:
 - Cold draft prevention
 - Outdoor temperature shift compensation
6. Terminal base for sensors and power supply

Accessories



PAW-RC2-MBS-1
Interface for connection to Modbus. For control of one unit via AHU kit with Modbus. 0-10V control is included.



PAW-RC2-MBS-4
Interface for connection to Modbus. For control of four units via AHU kit with Modbus. 0-10V control distributed per AHU control included.



PAW-RC-KNX-1i
Interface for connection to KNX. For control of one unit via AHU kit with KNX.



PAW-WTRAY
Condensation water drip tray by Mangelis for PAW-GRDSTD40 ground stand with 4 m heating cable including 3 °C thermostat.



PAW-GRDSTD40
Ground stand for PACi; height 400 mm, length 900 mm, width 400 mm.



PAW-GRDBSE20
2 Ground elevation of SBE; height 200 mm, length 600 mm.



PAW-WPH9
Wind protection shield for U-71PZH2E5/8.



PAW-WPH7
Wind protection shield for U-100/125/140PZH2E5/8.

Weather/snow hoods for PACi and ECOi outdoor units are necessary in order to achieve high performance in heating and cooling in severe climates. Weather/snow hoods are obligatory under heating and cooling operation with AHU. Weather/snow hoods are made of DX51D galvanized steel with RAL9002, easy to install thanks to preinstalled cage nuts. Anti-vibration rubber on contact surfaces. Laser cut, with rounded edges for easier installation and cleaning.

AIR CURTAINS



NEW
18

NEW Electric Air Curtain

			FY-3009U1	FY-3012U1	FY-3015U1
Width		mm	900	1200	1500
Voltage		V	220	220	220
Air volume	Hi / Lo	m ³ /h	1100/920	1400/1270	2000/1800
Consumption	Hi / Lo	W	76/70	94/85	131/110
Current	Hi / Lo	A	0,35/0,32	0,43/0,40	0,59/0,50
Air speed	Hi / Lo	m/s	10,50/8,50	9,50/8,00	10,50/9,50
Dimension	H x W x D	mm	900 x 231,5 x 212	1200 x 231,5 x 212	1500 x 231,5 x 212
Weight		kg	12,0	14,5	18,0
Sound pressure		dB(A)	48,5/45,0	48,5/44,5	51,5/48,0



Air Curtain with DX Coil

HP	4 HP			6 HP		8 HP						
Air Curtain	PAW-10PAIRC-MJ		PAW-15PAIRC-MJ		PAW-20PAIRC-MJ		PAW-10PAIRC-MS		PAW-20PAIRC-MS			
Air Flow type	Jet-Flow						Standard					
Air Flow length [A]		m	1,0		1,5		2,0		1,0		2,0	
Air volume	High / Medium / Low	m ³ /min	30,00/25,00/20,00		45,00/38,30/31,70		60,00/50,00/41,70		30,00/25,00/20,00		45,00/38,30/31,70	
Cooling capacity ¹		kW	9,20		17,50		23,10		9,20		17,50	
Heating capacity with air in 20 °C, air out 40 / 35 / 30 °C		kW	11,90/8,90/5,90		17,90/13,40/8,90		23,90/17,90/11,90		11,90/8,90/5,90		17,90/13,40/8,90	
Max installation height	Good / Normal / Bad	m	3,50/3,10/2,70		3,50/3,10/2,70		3,50/3,10/2,70		3,00/2,70/2,40		3,00/2,70/2,40	
Refrigerant			R410A		R410A		R410A		R410A		R410A	
Liquid pipe		Inch (mm)	3/8(9,52)		3/8(9,52)		3/8(9,52)		3/8(9,52)		3/8(9,52)	
Gas pipe		Inch (mm)	5/8(15,88)		3/4(19,05)		7/8(22,22)		5/8(15,88)		7/8(22,22)	
Fan			230V/50Hz/1/N/PE		230V/50Hz/1/N/PE		230V/50Hz/1/N/PE		230V/50Hz/1/N/PE		230V/50Hz/1/N/PE	
Fan type			EC		EC		EC		EC		EC	
Currency	High / Med / Low	A	2,10/0,80/0,30		2,80/1,10/0,40		4,20/1,60/0,60		2,10/0,80/0,30		4,20/1,60/0,60	
Electrical Consumption	High / Med / Low	kW	0,44/0,17/0,06		0,59/0,23/0,08		0,89/0,34/0,12		0,44/0,17/0,06		0,89/0,34/0,12	
Protecting Fuse		A	M16A		M16A		M16A		M16A		M16A	
Noise		dB(A)	40-55		40-56		40-57		40-55		40-57	
Dimension / Net weight	H x W x D	mm / kg	260 x 1210 x 590 / 70		260 x 1710 x 590 / 100		260 x 2210 x 590 / 138		260 x 1210 x 490 / 60		260 x 2210 x 490 / 128	

PACi Elite with air out 40 °C	10,00 kW	14,00 kW	20,00 kW	10,00 kW	14,00 kW
PACi Standard with air out 40 °C	10,00 kW	—	—	10,00 kW	—
PACi Elite with air out 35 °C	7,10 kW	10,00 kW	14,00 kW	7,10 kW	10,00 kW
PACi Standard with air out 35 °C	10,00 kW	10,00 kW	—	10,00 kW	10,00 kW
PACi Elite with air out 30 °C	5,00 kW	10,00 kW	10,00 kW	5,00 kW	10,00 kW
PACi Standard with air out 30 °C	6,00 kW	10,00 kW	10,00 kW	6,00 kW	10,00 kW

All combinations under rated conditions: Heating Outdoor +7 °C DB/+6 °C WB Indoor +20 °C DB. In case of lower outdoor temperatures a higher capacity outdoor unit model may be necessary. 1) Rated Conditions Cooling Outdoor +35 °C DB Indoor +27 °C DB/+19 °C WB. Discharge temperature ³ 16 °C.

PANASONIC PACi ELITE CAN COOL ROOMS DOWN TO 8 °C



Solutions for refrigeration rooms. Set the room temperature to 8 °C

There is a complete range, from 3,60 to 23,20 kW. This unique solution is perfect for:

Wine cellars, ice cream factories, flower shops, supermarkets, grain stores, food storage, food processing, food distribution, lunchrooms, vegetable processing... Just like all the indoor units in the PACi range, these units can be monitored via the Internet, generating an alarm if there is a breakdown.





Alternative controller.
Wired remote control.
CZ-RTC5B

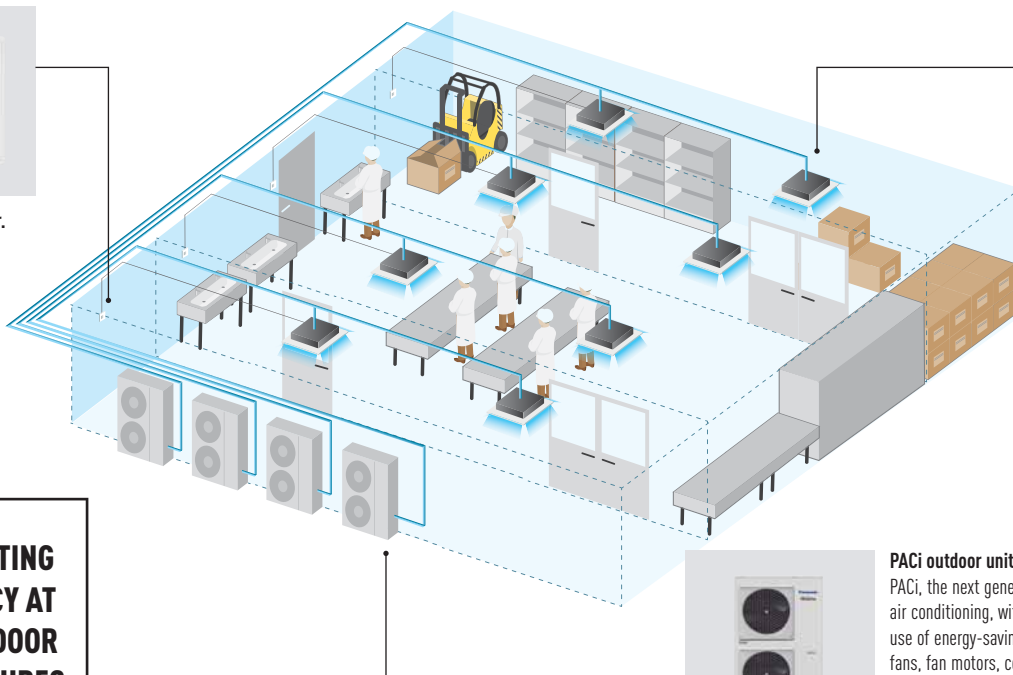

Wide range of indoor units.
To meet your company's needs

HIGH HEATING EFFICIENCY AT LOW OUTDOOR TEMPERATURES



PACi outdoor unit.
PACi, the next generation of developed commercial air conditioning, with an energy-saving concept. The use of energy-saving designs in the construction of fans, fan motors, compressors and heat exchangers has resulted in a high COP value.

Wine cellars and special low temperature rooms

One of the main features of the PACi series is the possibility of adjusting the product for special applications, not just for regular heating and cooling applications. The purpose of this product information is to explain in detail these special applications that need a cooling operation to maintain the room temperature at +8 ~ +24 °C WB (or +10 ~ +30 °C DB). In order to do this in terms of enthalpy, the indoor unit needs to be oversized and certain parameters need to be adjustable.

Temperature range – temperature range for wine cellar

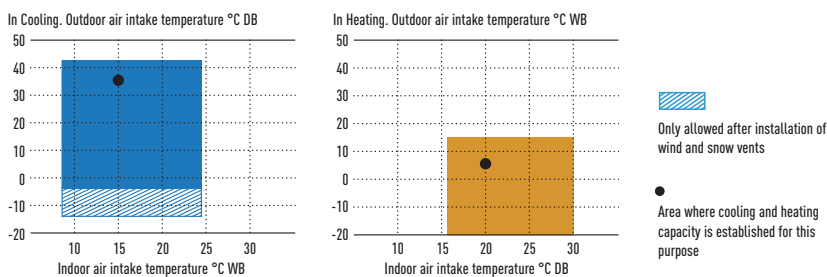

Temperature range for wine cellar

	Indoor	Outdoor
Cooling operation	+8 ~ +24 °C WB	-5 (-15) ~ 43 °C DB

Examples of installations:

To avoid the growth of bacteria and to increase food safety: Wine cellars, ice cream factories, flower shops, broiler factories, pantries in hotels, supermarkets, grain stores, food storage, food processing, food distribution, lunchrooms, salad processing ...

Application	Single						Twin		
	3,50 kW	4,90 kW	5,80 kW	6,90 kW	9,30 kW	11,60 kW	13,60 kW	18,50 kW	23,20 kW
Cooling capacity	U-36PE2E5A	U-50PE2E5A	U-60PE2E5A	U-71PE1E5A U-71PE1E8A	U-100PE1E5A U-100PE1E8A	U-125PE1E5A U-125PE1E8A	U-140PE1E5A U-140PE1E8A	U-200PE2E8A	U-250PE2E8A
PACi outdoor units									
PACi indoor units									
	S-60PT2E5B	S-71PT2E5B	S-100PT2E5B	S-125PT2E5B	S-140PT2E5B	S-140PT2E5B	S-100PT2E5B + S-100PT2E5B	S-125PT2E5B + S-125PT2E5B	S-140PT2E5B + S-140PT2E5B
	S-60PF1E5B	S-71PF1E5B	S-100PF1E5B	S-125PF1E5B	S-140PF1E5B	S-140PF1E5B	S-100PF1E5B + S-100PF1E5B	S-125PF1E5B + S-125PF1E5B	S-140PF1E5B + S-140PF1E5B
	S-60PN1E5B	S-71PN1E5B	S-100PN1E5B	S-125PN1E5B	S-140PN1E5B	S-140PN1E5B	S-100PN1E5B + S-100PN1E5B	S-125PN1E5B + S-125PN1E5B	S-140PN1E5B + S-140PN1E5B

* Above combinations require a special field setting. Please contact authorized Panasonic dealer.

PANASONIC AC SMART CLOUD

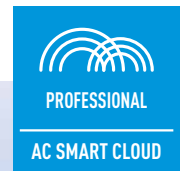

Flexible solution and scalable solution

- Energy saving
- Zero downtime
- Site(s) management

Centralize control of your business premises, from wherever you are, 24/7/365. It doesn't matter how many sites you have, or where they are! The AC Smart Cloud system from Panasonic allows you to have complete control of all your installations, from your tablet or from your computer. In a simple click, all your units from several locations, receive status updates in real-time of all your installations, preventing breakdowns and optimizing costs.

Flexible solution for your business.



Every time



Everywhere



Multiplatform



Internet browser

Scalable solution for your business.



Small to large



1 to multi sites



Upgrade features*



PACi / ECOi / ECO G

*Customized to meet user demand / Upgraded new functions / Upgraded by new products / IT smart management.

Panasonic AC Smart Cloud offers continuous improvement always thinking about users

New update from July 2018.

Home Screen.



- 3 blocks can be set with preferred information by users on home screen
- Home screen meets your needs well and this screen keeps as customized for you

Schedule function.



- Simple and intuitive page transition to make schedule setting easier
- Quick user guide for quick understanding

Location map display.

Site location with online map service.

Floor map edit.

Uploading new floor map. Edit floor maps.

Selectable zone. 3 preferred elements can be selected in 7 options.

1. IDU Operating Status
2. Energy Consumption graph
3. Weather information
4. Power usage vs target
5. Consumption figure vs yesterday
6. Efficiency
7. ECO-friendly Building Graph

With Panasonic AC Smart Cloud, have your business under control, and start saving!

Key functions and uniqueness

Multi site monitoring.

- It doesn't matter how many sites you have, easy to manage, operate, compare per sites, locations, rooms.



Powerful statistics for energy savings.

- Power consumption, capacity, efficiency level can be compared per different parameters (Yearly / monthly / weekly/ daily bases)



Schedule setting.

- Weekly / holiday timer setting as you want
- One setting can be copied to other sites
- Quick manual is available



Maintenance notification.

- Error notification by email and with floor layout
- Maintenance notification of ECOi / ECO G outdoor units
- **NEW!** Remote service checker function



User customization.

Site administrator can create users as desired and assign customized profiles.

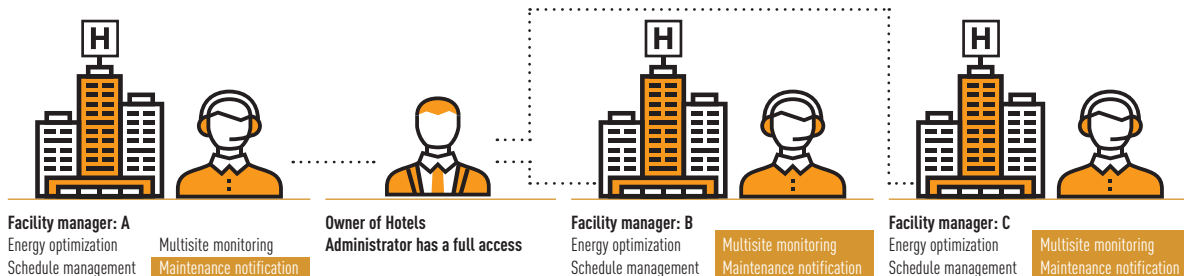

One of our uniqueness is “Stable and secured communication package”

- Connectivity is included in the service. Customers do not have to take time to find and prepare suitable connectivity.
- With an all inclusive service offering, the customer has peace of mind and a one stop shop for all AC Smart Cloud issues they may face including connectivity



New remote service checker function



Zero down time.

- Quick analysis & response
- Time & Cost saving for service maintenance task

Recording service checker parameters from wherever you are!

- Data duration: Max. 120 minutes
- Data frequency: 10 – 90 seconds
- Mode selection: With test run or Without test run
- Count down schedule setting available

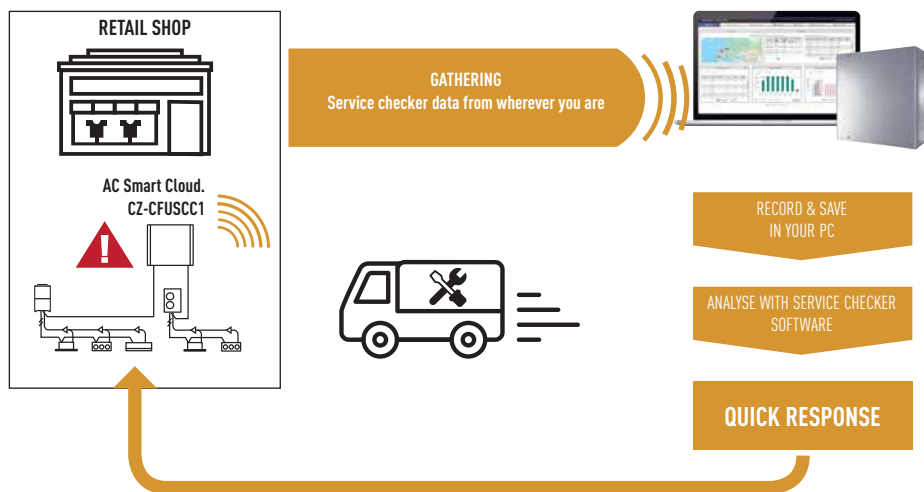

Panasonic AC Smart Cloud parts lists

* Cloud service fee is additionally required. Please contact an authorized Panasonic dealer.

CZ-CFUSCC1	AC Smart Cloud communication adaptor. Up to 128 groups. 128 units control
PAW-MVNOAC-V	3G communication package (SIM Card included). V, K: Depending on countries ¹⁾
PAW-MVNOAC-K	

1) Please contact an authorized Panasonic dealer.

ACCESSORIES & CONTROL

Panels



CZ-BT20EW
NEW RAL9010 panel for 4 Way 60x60 Cassette.



CZ-KPY3AW
Panel for 4 Way 60x60 Cassette size 700x700 mm.



CZ-KPY3BW
Panel for 4 Way 60x60 Cassette size 625x625mm.



CZ-KPU3
Normal panel for 4 Way 90x90 Cassette.



CZ-KPU3A
Econavi panel for 4 Way 90x90 Cassette.

Other Accessory



CZ-CNEXU1
nanoe™ X air purifying system for 4 Way 90x90 Cassette.



CZ-CENSC1
Econavi energy savings sensor.

Outdoor accessories



PAW-WTRAY
Tray for condenser water compatible with base ground support.



PAW-GRDSTD40
Outdoor elevation platform 400x900x400 mm.



PAW-GRDBSE20
Outdoor base ground support for noise and vibration absorption (600 x 95 x 130 mm, 500kg).



PAW-WPH9
Wind protection shield for U-71PZH2E5/8.



PAW-WPH7
Wind protection shield for U-100/125/140PZH2E5/8.

Branch Pipes, Header

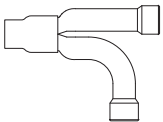

CZ-P155BK1
Branch pipe (capacity after distribution is 16,00 kW or less).

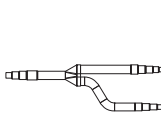

CZ-P224BK2BM
Branch pipe (capacity after distribution is 22,40 kW or less).

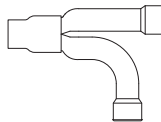

CZ-P680BK2BM
Branch pipe (from 22,40 kW to 68,00 kW).

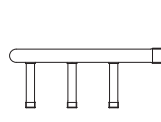

CZ-P3HPC2BM
Header.

Plenums



CZ-DUMPA160MF2
Air Inlet Plenum S . .PF1E5B 100, 125 & 140.

CZ-56DAF2
Air Outlet Plenum S . .PF1E5B 36, 45 & 50.

CZ-DUMPA90MF2
Air Inlet Plenum S . .PF1E5B 60 & 71.

CZ-90DAF2
Air Outlet Plenum S . .PF1E5B 60 & 71.

CZ-160DAF2
Air Outlet Plenum S . .PF1E5B 100, 125 & 140.

CZ-TREMIESPW705
Air Outlet Plenum S-200PE2E5.

CZ-TREMIESPW706
Air Outlet Plenum S-250PE2E5.

Individual Controls



CZ-RTC5B
Design wired remote controller with Econavi button and datanavi.



CZ-RTC4
Remote controller for maintenance setting.



CZ-RWS3 + CZ-RWRU3
Wireless remote control for 4 Way 90x90 Cassette.



CZ-RWS3
Wireless remote control for Wall Mounted and 4 Way 60x60 (with CZ-KPY3AW).

Controller for Hotels with Dry Contacts



PAW-RE2C3-WH
Stand-Alone with I/O White frame.

PAW-RE2C3-MOD-WH
Modbus RS-485 with I/O White frame.

PAW-RE2C3-LON-WH
LonWorks TP/FT-10 with I/O White frame.

PAW-RE2C3-GR
Stand-Alone with I/O Grey Frame.

PAW-RE2C3-MOD-GR
Modbus RS-485 with I/O Grey frame.

PAW-RE2C3-LON-GR
LonWorks TP/FT-10 with I/O Grey frame.



CZ-RWS3 + CZ-RWRT3
Wireless remote control for Ceiling.



CZ-RWS3 + CZ-RWRC3
Wireless remote control for all indoor units.



CZ-RE2C2
Simplified remote control.



CZ-CSRC3
Temperature Remote sensor.

Centralised Controls



CZ-64ESMC3
System Controller with Schedule timer. Operation with various function from center station.



CZ-ANC3
Central On/Off controller, up to 16 groups, 64 indoor units.



CZ-256ESMC3
Simplified load distribution ratio (LDR) for each tenant. Intelligent Controller (Touch screen panel).

Centralised Controls. BMS System. PC Base



CZ-CSWKC2
PAIMS Basic software.



CZ-CSWAC2
PAIMS Consumption calculation control.

CZ-CSWGC2
PAIMS - Layout display.



CZ-CAPDC
Serial parallel device controlling outdoor units, up to 4 units.



CZ-CAPC3
Adaptor for On/off control of external devices.



CZ-CAPBC2
Mini series parallel device controlling indoor units, maximum 1 group and 8 indoor unit.



CZ-CFUNC2
Communication Adaptor. Up to 128 groups. Controls 128 units.

CZ-CFUNC2
Communication adaptor.

CZ-CSWBC2
PAIMS - BACnet interface.

CZ-CSWWC2
PAIMS - Web application.

VRF Smart Connectivity



SER8150R0B1194
Remote Controller Panasonic Net Con, RH, No PIR, R1/R2.



SER8150R5B1194
Remote Controller Panasonic Net Con, RH, PIR, R1/R2.

VCM8000V5094P
Wireless Zigbee Pro module / Green Com card.



SED-WDC-G-5045
Door / window wireless sensor.



SED-MTH-G-5045
Wall / ceiling (motion) wireless sensor.

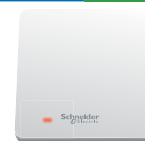

SED-CO2-G-5045
CO₂ sensor.

Accessories Interfaces



PAW-RC2-WIFI-1
Interface for Intesishome for PACi & ECOi.



PAW-RC2-KNX-1i
KNX Interface.



PAW-RC2-MBS-4
Modbus interface to control 4 indoor/groups.



PAW-RC2-MBS-1
Modbus Interface.



CZ-CFUSCC1
Panasonic AC Smart Cloud. Cloud internet control. Up to 128 groups. Controls 128 units.

PAW-MVNOAC-V
PAW-MVNOAC-K
3G communication package (SIM Card included). V, K: Depending on countries.



PAW-MBS-TCP2RTU
ModBus RTU Slave devices.



PAW-RC2-BAC-1
BACnet Interface.



CZ-CAPRA1
RAC interface adapter for integration into P Link.

Panasonic AC Smart Cloud

Accessories PCB



PAW-T10V
All T10 functions + powermonitoring.

PAW-T10H
ON/OFF; Prohibit 5VDC & 230VAC.



PAW-PACR3
Redundancy of 2 or 3 systems; for PACi and ECOi.



PAW-SERVER-PKEA
Redundancy of 2 units TKEA.

PAW-T10
All T10 functions.

PAW-T10HW
ON/OFF; Prohibit 5VDC.

Accessories Cables



CZ-T10
Cable for all the T10 functions.



PAW-FDC
Cable to operate external EC fan.



PAW-OCT
Cable for all option monitoring signals.



CZ-CAPE2
Option monitoring signals wo. Fan.

PAW-EXCT
Cable with force Thermo OFF/leakage Detection.

INDUSTRIAL VRF SYSTEMS



Professional solutions for all types of projects.

The new Panasonic VRF System is specifically designed for energy saving, easy installation and high efficiency performance, with a wide choice of outdoor and indoor unit models and unique features which are designed for the most demanding offices and big buildings.

ECO *i* EX

ECO *i*

ECO G

VRF Systems ECOi EX.

A VRF System delivering energy-saving performance, powerful operation, reliability and comfort surpassing anything previously possible. It represents a true paradigm shift in air conditioning solutions.



Mini ECOi LE Series.

The Mini ECOi combines smartly compact body with high specifications. It delivers high levels of energy-saving, powerful operation, reliability and comfort.

The Panasonic solution for chilled and hot water production!

For hydronic Applications. Energy-efficient capacity control. Stainless steel plate heat exchanger with anti-freeze protection control. Change over between heating and cooling operation.



VRF Smart Connectivity.

Panasonic's VRF Smart Connectivity is a completely new, state-of-the-art solution providing energy saving and comfort as well as simple installation, operation and running.

Panasonic AC Smart Cloud.

Centralised control of your business premises, from wherever 24/7. Smartly control, maintain, optimise and save.



RANGE OF VRF OUTDOOR UNITS

Page Outdoor units 4 HP 5 HP 6 HP 8 HP

P. 142 Mini ECOi LE2 / LE1 Series



U-4LE2E5 / U-4LE2E8

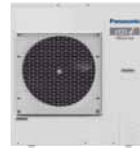

U-5LE2E5 / U-5LE2E8

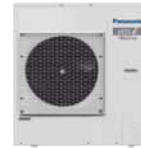

U-6LE2E5 / U-6LE2E8



U-8LE1E8

P. 144 2-Pipe ECOi EX ME2 Series High Efficiency Model



U-8ME2E8

P. 148 2-Pipe ECOi EX ME2 Series Space Saving Model



U-8ME2E8

P. 152 **NEW** 3-Pipe ECOi EX MF3 Series



U-8MF3E8

10 HP

12 HP

14 HP

16 HP

18 HP

20 HP



U-10LE1E8



U-10ME2E8



U-12ME2E8



U-14ME2E8



U-16ME2E8



U-10ME2E8



U-12ME2E8



U-14ME2E8



U-16ME2E8



U-18ME2E8



U-20ME2E8



U-10MF3E8



U-12MF3E8



U-14MF3E8



U-16MF3E8

MINI ECOi LE SERIES



**COMPACT
DESIGN**

Mini ECOi LE Series for commercial & residential use

Advantages of Mini ECOi LE Series used for medium sized buildings.

- 1. Installation.** Improvements including compact outdoor unit design, long piping and high pressure of 35Pa allow easier installation of units in condominiums and medium sized buildings with limited spaces.
- 2. Energy Control.** The use of R410A refrigerant, the Inverter compressor, and the design of the outdoor unit fan and heat exchanger contributes to high efficiency resulting to lower energy consumption.
- 3. Reliability.** Panasonic air conditioners are built to operate in wide temperature range (-20 to 46 °C). Using the Bluefin treatment and condenser, outdoor units are also durable against harsh environments like rain and sea breeze.

7,85 | 4,87*
SEER | SCOP
INDUSTRY LEADING
EFFICIENCY



LE2 Series - 4 / 5 / 6 HP

6,37*
SEER
4,31
SCOP



LE1 Series - 8 / 10 HP

Compact design: LE2 Series - 4 / 5 / 6 HP

- Extraordinary energy saving: 7,85 SEER and 4,87 SCOP (4 HP)*
- 50 m piping length without additional refrigerant charge
- Quiet operation mode with 4 levels
- High COP mode option

LE1 Series - 8 / 10 HP

- 60 % smaller than ECOi ME2 8 / 10 HP with vertical flow type
- Flexible piping length (Total : 300m, Furthest : 150m)
- Maximum number of connectable indoor units: 15

Key features for LE2 / LE1

- High external static pressure 35Pa
- Full range of ECOi indoor units and controllers
- Variable evaporation temperature control as standard
- Connectable maximum indoor / outdoor capacity ratio up to 130 %
- Auto restart from outdoor units
- Demand response (Peak cut) by optional parts
- Suitable for R22 renewable projects

* SEER/SCOP is calculated based on the seasonal space cooling/heating efficiency "η₁" values of the COMMISSION REGULATION (EU) 2016/2281. SEER, SCOP = (η₁ + Correction) × PEF.



Mini ECOi LE Series High Efficiency

HP			4 HP	5 HP	6 HP	4 HP	5 HP	6 HP	8 HP	10 HP
Outdoor units			U-4LE2E5	U-5LE2E5	U-6LE2E5	U-4LE2E8	U-5LE2E8	U-6LE2E8	U-8LE1E8	U-10LE1E8
Power supply	Voltage	V	220/230/240	220/230/240	220/230/240	380/400/415	380/400/415	380/400/415	380/400/415	380/400/415
	Phase		Single Phase	Single Phase	Single Phase	Three Phase	Three Phase	Three Phase	Three Phase	Three Phase
	Frequency	Hz	50	50	50	50	50	50	50	50
Cooling capacity	kW		12,10	14,00	15,50	12,10	14,00	15,50	22,40	28,00
EER ¹⁾	W/W		4,50	4,06	3,73	4,50	4,06	3,73	3,80	3,11
SEER ²⁾	W/W		7,85	7,48	7,25	7,85	7,48	7,25	6,27	6,37
Running current cooling	A		13,30/12,70/12,20	16,30/15,60/17,00	20,30/19,40/18,60	4,39/4,17/4,02	5,58/5,30/5,11	6,71/6,37/6,14	9,60/9,15/8,80	14,70/14,00/13,50
Input power cooling	kW		2,69	3,45	4,15	2,69	3,45	4,15	5,89	9,00
Heating capacity	kW		12,50	16,00	16,5	12,50	16,00	16,50	25,00	28,00
COP ¹⁾	W/W		5,19	4,60	4,27	5,19	4,60	4,27	4,02	3,93
SCOP ²⁾	W/W		4,87	4,40	4,24	4,87	4,40	4,24	4,24	4,31
Running current heating	A		12,20/11,60/11,20	17,60/16,80/16,10	19,10/18,20/17,50	3,98/3,78/3,64	5,62/5,34/5,14	6,24/5,93/5,71	10,20/9,65/9,30	11,60/11,10/10,70
Input power heating	kW		2,41	3,48	3,86	2,41	3,48	3,86	6,22	7,13
Starting current	A		1,00	1,00	1,00	1,00	1,00	1,00	1,00	1,00
Maximum current	A		17,30	24,30	27,40	7,90	10,10	10,70	13,70	19,60
Maximum input power	kW		3,50/3,66/3,82	4,92/5,14/5,37	5,61/5,86/6,12	4,34/5,09/5,28	6,25/6,55/6,82	6,62/6,97/7,23	9,16	13,10
Maximum number of connectable indoor units			7 [10] ³⁾	8 [10] ³⁾	9 [12] ³⁾	7 [10] ³⁾	8 [10] ³⁾	9 [12] ³⁾	15 ⁴⁾	15 ⁴⁾
External static pressure	Pa		0~35	0~35	0~35	0~35	0~35	0~35	0~35	0~35
Air volume	m ³ /min		69	72	74	69	72	74	150	160
Sound pressure	Cool	dB(A)	52	53	54	52	53	53	60	63
	Cool (Silent 1/2/3/4)	dB(A)	50,5/49/47/45	51,5/50/48/46	52,5/51/48/46	50,5/49/49/47	48,5/50/48/46	48,5/50/48/46	57/55/53	60/58/56
	Heat	dB(A)	54	56	56	54	56	56	64	65
Sound power	Cool / Heat	dB	69/72	71/75	73/75	69/72	71/75	73/75	81/85	84/86
Dimension	H x W x D	mm	996 x 980 x 370	996 x 980 x 370	996 x 980 x 370	996 x 980 x 370	996 x 980 x 370	996 x 980 x 370	1500 x 980 x 370	1500 x 980 x 370
Net weight	kg		106	106	106	106	106	106	132	133
Piping connections	Liquid pipe	Inch (mm)	3/8(9,52)	3/8(9,52)	3/8(9,52)	3/8(9,52)	3/8(9,52)	3/8(9,52)	3/8(9,52) ⁵⁾ 1/2(12,70) ⁶⁾	3/8(9,52) ⁵⁾ 1/2(12,70) ⁶⁾
	Gas pipe	Inch (mm)	5/8(15,88)	5/8(15,88)	5/8(15,88)	5/8(15,88)	5/8(15,88)	5/8(15,88)	7/8(22,22) ⁵⁾ 1(25,40) ⁶⁾	7/8(22,22) ⁵⁾ 1(25,40) ⁶⁾
Maximum piping length (total)	m		150(180)	150(180)	150(180)	150(180)	150(180)	150(180)	7,5~150 (7,5~300)	7,5~150 (7,5~300)
Elevation difference (in/out)	m		50(Outdoor unit upper)/ 40(Outdoor unit lower)	50(Outdoor unit upper)/ 40(Outdoor unit lower)	50(Outdoor unit upper)/ 40(Outdoor unit lower)	50(Outdoor unit upper)/ 40(Outdoor unit lower)	50(Outdoor unit upper)/ 40(Outdoor unit lower)	50(Outdoor unit upper)/ 40(Outdoor unit lower)	50(Outdoor unit upper)/ 40(Outdoor unit lower)	50(Outdoor unit upper)/ 40(Outdoor unit lower)
Refrigerant (R410A)	kg/TCO ₂ Eq.		6,70(14,40)/ 13,9896	6,70(14,40)/ 13,9896	6,70(14,40)/ 13,9896	6,70(14,40)/ 13,9896	6,70(14,40)/ 13,9896	6,70(14,40)/ 13,9896	6,30(24,00)/ 13,1544	6,60(24,00)/ 13,7808
Maximum allowable indoor / outdoor capacity ratio	%		50~130	50~130	50~130	50~130	50~130	50~130	50~130	50~130
Operating range	Cool Min ~ Max	°C	-10~+46	-10~+46	-10~+46	-10~+46	-10~+46	-10~+46	-10~+46	-10~+46
	Heat Min ~ Max	°C	-20~+18	-20~+18	-20~+18	-20~+18	-20~+18	-20~+18	-20~+18	-20~+18

1) EER and COP calculation is based in accordance to EN14511. 2) SEER/SCOP is calculated based on the seasonal space cooling/heating efficiency "η₁" values of the COMMISSION REGULATION (EU) 2016/2281. SEER, SCOP = (η₁ + Correction) × PEF. 3) In case of 1,50 kW indoor unit's connection, able to connect maximum 12 indoor units. 4) If the heating utilized, it is necessary to increase 1 size with respect to the main liquid pipe, depending on the combination of the indoor unit. 5) Under 90m for ultimate indoor unit. 6) Over 90m for ultimate indoor unit. If the longest piping equivalent length exceeds 90m, increase the sizes of the main tubes by 1 rank for gas and liquid pipes.



INTERNET CONTROL: Optional.

2-PIPE ECOi EX THE GAME CHANGER



Energy-saving performance, powerful operation, reliability and comfort surpassing anything previously possible.

High performance at extreme conditions

ECOi EX is highly reliable, with strong cooling & heating power, even when operating at extreme ambient temperatures. The units can operate at 100 % of capacity at 43 °C, reaching a great cooling operation up to 52 °C and in heating -25 °C.

Also, the ECOi EX features include Bluefin in newly designed heat exchanger improving efficiency as well in marine ambient. A silicone coated PCB (Printed Circuit Board) protects the unit from being damaged by environmental factors such as moisture and dust.

Superior flexibility

With its up to 1000 meters of pipeline, its maximum 30 meters height difference between indoor units and its 200 meters length, the design possibilities have grown exponentially making the new ECOi EX the ideal air conditioning option for long haul buildings, such as train stations, airports, schools or hospitals. These advantages are enhanced with the wide range of indoor unit models and capacities facilitating the perfect adaptation to all kind of projects. The careful selection of controls and peripherals such as the Pump Down, the AHU or/and the chiller, enables an optimum system use.

Connectable maximum allowable indoor / outdoor capacity ratio up to 200 %.

Outstanding efficiency and comfort

The new ECOi EX system is designed to increase energy efficiency by delivering high SEER rating, as well as high efficiency for part-load operations.

The system has reduced energy costs thanks to "All-Inverter Compressors", with independent control to deliver highly flexible performance. Also, the ECOi EX features an enlarged heat exchanger with triple surfaces that allow for improved heat transfer and a newly designed curved air discharge bell-mouth for better aerodynamics. The three-stage oil recovery design makes it able to minimise the frequency of forced oil recovery, leading to reduced energy costs and sustained comfort.

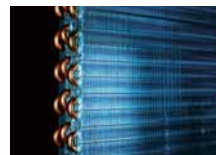

Enlarged heat exchanger surface area with triple surface.

* For 8 & 10 HP unit, the heat exchanger is 2 row design.



Multiple large-capacity all inverter compressors (more than 14 HP).



Newly designed curved air discharge bell mouth for better aerodynamics.

VRF with outstanding energy-saving performance and powerful operation SEER 7,56 (18 HP model).



2-Pipe ECOi EX ME2 Series High Efficiency Model

			8 HP	10 HP	12 HP	14 HP	16 HP
Outdoor units			U-8ME2E8	U-10ME2E8	U-12ME2E8	U-14ME2E8	U-16ME2E8
Power supply	Voltage	V	380/400/415	380/400/415	380/400/415	380/400/415	380/400/415
	Phase		Three Phase	Three Phase	Three Phase	Three Phase	Three Phase
	Frequency	Hz	50	50	50	50	50
Cooling capacity	kW		22,40	28,00	33,50	40,00	45,00
EER ¹⁾	W/W		4,70	4,37	3,96	3,88	3,52
ESEER	W/W		9,33	8,67	7,94	7,73	7,19
SEER ²⁾	W/W		7,43	6,83	6,65	7,23	6,43
Running current cooling	A		7,40/7,14	10,20/9,80	13,00/12,50	16,50/15,90	20,10/19,40
Input power cooling	kW		4,77	6,41	8,47	10,30	12,80
Heating capacity	kW		25,00	31,50	37,50	45,00	50,00
COP ¹⁾	W/W		5,13	4,76	4,73	4,56	4,42
SCOP ²⁾	W/W		4,79	4,26	4,72	4,28	4,05
Running current heating	A		7,56/7,29	10,50/10,10	12,30/11,80	15,80/15,20	17,90/17,30
Input power heating	kW		4,87	6,62	7,92	9,86	11,30
Starting current	A		1,00	1,00	1,00	2,00	2,00
External static pressure (Max)	Pa		80	80	80	80	80
Air volume	m ³ /min		224	224	232	232	232
Sound pressure	Normal mode	dB(A)	54	56	59	60	61
	Silent mode	dB(A)	51	53	56	57	58
Sound power	Normal mode	dB	75	77	80	81	82
Dimension	HxWxD	mm	1842x770x1000	1842x770x1000	1842x1180x1000	1842x1180x1000	1842x1180x1000
Net weight	kg		210	210	270	315	315
Piping connections ³⁾	Liquid pipe	Inch (mm)	3/8(9,52)/ 1/2(12,70)	3/8(9,52)/ 1/2(12,70)	1/2(12,70)/ 5/8(15,88)	1/2(12,70)/ 5/8(15,88)	1/2(12,70)/ 5/8(15,88)
	Gas pipe	Inch (mm)	3/4(19,05)/ 7/8(22,22)	7/8(22,22)/ 1(25,40)	1(25,40)/ 1-1/8(28,58)	1(25,40)/ 1-1/8(28,58)	1-1/8(28,58)/ 1-1/4(31,75)
	Balance pipe	Inch (mm)	1/4(6,35)	1/4(6,35)	1/4(6,35)	1/4(6,35)	1/4(6,35)
Refrigerant (R410A)	kg/TCO ₂ Eq.		5,60/11,6928	5,60/11,6928	8,30/17,3304	8,30/17,3304	8,30/17,3304
Maximum allowable indoor / outdoor capacity ratio % ⁴⁾			50 ~ 130(200)	50 ~ 130(200)	50 ~ 130(200)	50 ~ 130(200)	50 ~ 130(200)
Operating range	Cool Min ~ Max	°C	-10 ~ +52	-10 ~ +52	-10 ~ +52	-10 ~ +52	-10 ~ +52
	Heat Min ~ Max	°C	-25 ~ +18	-25 ~ +18	-25 ~ +18	-25 ~ +18	-25 ~ +18

1) EER and COP calculation is based in accordance to EN14511. 2) SEER/SCOP is calculated based on the seasonal space cooling/heating efficiency "η" values of the COMMISSION REGULATION (EU) 2016/2281. SEER, SCOP = (η + Correction) × PEf. 3) Pipe diameter under 90m for ultimate indoor unit / over 90m for ultimate indoor unit (if the longest piping equivalent length exceeds 90m, increase the sizes of the main tubes by 1 rank for gas tubes and liquid tubes). 4) If the following conditions are satisfied, the effective range is above 130 % and below 200 %: A. Obey the limited number of connectable indoor units. B. The lower limit of operating range for heating outdoor temperature is limited to -10 °C WB (standard -25 °C WB). C. Simultaneous operation is limited to less than 130 % of connectable indoor units.



2-Pipe ECOi EX ME2 Series High Efficiency Model Combination from 18 to 28 HP

			18 HP	20 HP	22 HP	24 HP	26 HP	28 HP
			U-8ME2E8	U-10ME2E8	U-10ME2E8	U-12ME2E8	U-10ME2E8	U-12ME2E8
			U-10ME2E8	U-10ME2E8	U-12ME2E8	U-12ME2E8	U-16ME2E8	U-16ME2E8
Power supply	Voltage	V	380/400/415	380/400/415	380/400/415	380/400/415	380/400/415	380/400/415
	Phase		Three Phase	Three Phase	Three Phase	Three Phase	Three Phase	Three Phase
	Frequency	Hz	50	50	50	50	50	50
Cooling capacity		kW	50,00	56,00	61,50	68,00	73,00	78,50
EER ¹⁾		W/W	4,55	4,38	4,13	3,93	3,80	3,69
Running current cooling		A	17,30/16,60	20,30/19,60	23,10/22,30	26,60/25,60	30,10/29,00	33,10/31,90
Input power cooling		kW	11,00	12,80	14,90	17,30	19,20	21,30
Heating capacity		kW	56,00	63,00	69,00	76,50	81,50	87,50
COP ¹⁾		W/W	4,96	4,77	4,76	4,69	4,55	4,56
Running current heating		A	17,70/17,10	20,90/20,20	22,70/21,90	25,30/24,40	28,40/27,40	30,10/29,00
Input power heating		kW	11,30	13,20	14,50	16,30	17,90	19,20
Starting current		A	2,00	2,00	2,00	2,00	3,00	3,00
External static pressure (Max)		Pa	80	80	80	80	80	80
Air volume		m ³ /min	448	448	456	464	456	464
Sound pressure	Normal / Silent mode	dB(A)	58,50/55,50	59,00/56,00	61,00/58,00	62,00/59,00	62,50/59,50	63,50/60,50
Sound power	Normal mode	dB	79,50	80,00	82,00	83,00	83,50	84,50
Dimension / Net weight	H x W x D	mm / kg	1842 x 1600 x 1000 / 420	1842 x 1600 x 1000 / 420	1842 x 2010 x 1000 / 480	1842 x 2420 x 1000 / 540	1842 x 2010 x 1000 / 535	1842 x 2420 x 1000 / 585
	Piping connections ²⁾							
Piping connections ²⁾	Liquid pipe	Inch (mm)	5/8(15,88)/3/4(19,05)	5/8(15,88)/3/4(19,05)	5/8(15,88)/3/4(19,05)	5/8(15,88)/3/4(19,05)	3/4(19,05)/7/8(22,22)	3/4(19,05)/7/8(22,22)
	Gas pipe	Inch (mm)	1-1/8(28,58)/1-1/4(31,75)	1-1/8(28,58)/1-1/4(31,75)	1-1/8(28,58)/1-1/4(31,75)	1-1/8(28,58)/1-1/4(31,75)	1-1/4(31,75)/1-1/2(38,10)	1-1/4(31,75)/1-1/2(38,10)
	Balance pipe	Inch (mm)	1/4(6,35)	1/4(6,35)	1/4(6,35)	1/4(6,35)	1/4(6,35)	1/4(6,35)
Refrigerant (R410A)		kg/TCO ₂ Eq.	11,20/23,3856	11,20/23,3856	13,90/29,0232	16,60/34,6608	13,90/29,0232	16,60/34,6608
Maximum allowable indoor / outdoor capacity ratio % ³⁾			50 ~ 130(200)	50 ~ 130(200)	50 ~ 130(200)	50 ~ 130(200)	50 ~ 130(200)	50 ~ 130(200)
Operating range	Cool Min ~ Max	°C	-10 ~ +52	-10 ~ +52	-10 ~ +52	-10 ~ +52	-10 ~ +52	-10 ~ +52
	Heat Min ~ Max	°C	-25 ~ +18	-25 ~ +18	-25 ~ +18	-25 ~ +18	-25 ~ +18	-25 ~ +18

2-Pipe ECOi EX ME2 Series High Efficiency Model Combination from 30 to 40 HP

			30 HP	32 HP	34 HP	36 HP	38 HP	40 HP
			U-14ME2E8	U-16ME2E8	U-10ME2E8	U-12ME2E8	U-10ME2E8	U-12ME2E8
			U-16ME2E8	U-16ME2E8	U-12ME2E8	U-12ME2E8	U-12ME2E8	U-12ME2E8
Power supply	Voltage	V	380/400/415	380/400/415	380/400/415	380/400/415	380/400/415	380/400/415
	Phase		Three Phase	Three Phase	Three Phase	Three Phase	Three Phase	Three Phase
	Frequency	Hz	50	50	50	50	50	50
Cooling capacity		kW	85,00	90,00	96,00	101,00	107,00	113,00
EER ¹⁾		W/W	3,68	3,52	4,05	3,95	3,84	3,75
Running current cooling		A	36,60/35,30	40,20/38,70	36,80/35,50	39,30/37,90	43,80/42,20	46,70/45,00
Input power cooling		kW	23,10	25,60	23,70	25,60	27,90	30,10
Heating capacity		kW	95,00	100,00	108,00	113,00	119,00	127,00
COP ¹⁾		W/W	4,48	4,42	4,72	4,73	4,61	4,57
Running current heating		A	33,60/32,40	35,80/34,60	35,90/34,60	37,10/35,80	40,50/39,00	43,60/42,00
Input power heating		kW	21,20	22,60	22,90	23,90	25,80	27,80
Starting current		A	4,00	4,00	3,00	3,00	4,00	4,00
External static pressure (Max)		Pa	80	80	80	80	80	80
Air volume		m ³ /min	464	464	688	696	688	696
Sound pressure	Normal / Silent mode	dB(A)	63,50/60,50	64,00/61,00	63,00/60,00	64,00/61,00	64,00/61,00	64,50/61,50
Sound power	Normal mode	dB	84,50	85,00	84,00	85,00	85,00	85,50
Dimension / Net weight	H x W x D	mm / kg	1842 x 2420 x 1000 / 630	1842 x 2420 x 1000 / 630	1842 x 3250 x 1000 / 750	1842 x 3660 x 1000 / 810	1842 x 3250 x 1000 / 795	1842 x 3660 x 1000 / 855
	Piping connections ²⁾							
Piping connections ²⁾	Liquid pipe	Inch (mm)	3/4(19,05)/7/8(22,22)	3/4(19,05)/7/8(22,22)	3/4(19,05)/7/8(22,22)	3/4(19,05)/7/8(22,22)	3/4(19,05)/7/8(22,22)	3/4(19,05)/7/8(22,22)
	Gas pipe	Inch (mm)	1-1/4(31,75)/1-1/2(38,10)	1-1/4(31,75)/1-1/2(38,10)	1-1/4(31,75)/1-1/2(38,10)	1-1/2(38,10)/1-5/8(41,28)	1-1/2(38,10)/1-5/8(41,28)	1-1/2(38,10)/1-5/8(41,28)
	Balance pipe	Inch (mm)	1/4(6,35)	1/4(6,35)	1/4(6,35)	1/4(6,35)	1/4(6,35)	1/4(6,35)
Refrigerant (R410A)		kg/TCO ₂ Eq.	16,60/34,6608	16,60/34,6608	22,20/46,3536	24,90/51,9912	22,20/46,3536	24,90/46,3536
Maximum allowable indoor / outdoor capacity ratio % ³⁾			50 ~ 130(200)	50 ~ 130(200)	50 ~ 130(200)	50 ~ 130(200)	50 ~ 130(200)	50 ~ 130(200)
Operating range	Cool Min ~ Max	°C	-10 ~ +52	-10 ~ +52	-10 ~ +52	-10 ~ +52	-10 ~ +52	-10 ~ +52
	Heat Min ~ Max	°C	-25 ~ +18	-25 ~ +18	-25 ~ +18	-25 ~ +18	-25 ~ +18	-25 ~ +18

Data is for reference. 1) EER and COP calculation is based in accordance to EN14511. 2) Pipe diameter under 90m for ultimate indoor unit / over 90m for ultimate outdoor unit (if the longest piping equivalent length exceeds 90m, increase the sizes of the main tubes by 1 rank for gas tubes and liquid tubes). 3) If the following conditions are satisfied, the effective range is above 130% and below 200%: A. Obey the limited number of connectable indoor units. B. The lower limit of operating range for heating outdoor temperature is limited to -10 °C WB (standard -25 °C WB). C. Simultaneous operation is limited to less than 130% of connectable indoor units.

2-Pipe ECOi EX ME2 Series High Efficiency Model Combination from 42 to 52 HP

			42 HP	44 HP	46 HP	48 HP	50 HP	52 HP
			U-10ME2E8	U-12ME2E8	U-14ME2E8	U-16ME2E8	U-10ME2E8	U-12ME2E8
			U-16ME2E8	U-16ME2E8	U-16ME2E8	U-16ME2E8	U-12ME2E8	U-12ME2E8
			U-16ME2E8	U-16ME2E8	U-16ME2E8	U-16ME2E8	U-12ME2E8	U-16ME2E8
Model name	U-10ME2E8							
	U-16ME2E8							
	U-16ME2E8							
Power supply	Voltage	V	380/400/415	380/400/415	380/400/415	380/400/415	380/400/415	380/400/415
	Phase		Three Phase	Three Phase	Three Phase	Three Phase	Three Phase	Three Phase
	Frequency	Hz	50	50	50	50	50	50
Cooling capacity		kW	118,00	124,00	130,00	135,00	140,00	145,00
EER ¹⁾		W/W	3,69	3,62	3,62	3,52	3,87	3,82
Running current cooling		A	50,20/48,40	53,20/51,30	56,90/54,90	60,20/58,10	56,20/54,20	59,00/56,80
Input power cooling		kW	32,00	34,30	35,90	38,40	36,20	38,00
Heating capacity		kW	132,00	138,00	145,00	150,00	155,00	160,00
COP ¹⁾		W/W	4,49	4,50	4,46	4,42	4,65	4,66
Running current heating		A	46,60/44,90	48,20/46,40	51,50/49,70	53,80/51,80	52,20/50,40	53,80/51,90
Input power heating		kW	29,40	30,70	32,50	33,90	33,30	34,30
Starting current		A	5,00	5,00	6,00	6,00	5,00	5,00
External static pressure (Max)		Pa	80	80	80	80	80	80
Air volume		m ³ /min	688	696	696	696	920	928
Sound pressure	Normal / Silent mode	dB(A)	65,00/62,00	65,50/62,50	65,50/62,50	66,00/63,00	65,50/62,50	66,00/63,00
Sound power	Normal mode	dB	86,00	86,50	86,50	87,00	86,50	87,00
Dimension / Net weight	H x W x D	mm / kg	1842 x 3250 x 1000/840	1842 x 3660 x 1000/900	1842 x 3660 x 1000/945	1842 x 3660 x 1000/945	1842 x 4490 x 1000/1065	1842 x 4900 x 1000/1125
Piping connections ²⁾	Liquid pipe	Inch (mm)	3/4(19,05)/7/8(22,22)	3/4(19,05)/7/8(22,22)	3/4(19,05)/7/8(22,22)	3/4(19,05)/7/8(22,22)	3/4(19,05)/7/8(22,22)	3/4(19,05)/7/8(22,22)
	Gas pipe	Inch (mm)	1-1/2(38,10)/1-5/8(41,28)	1-1/2(38,10)/1-5/8(41,28)	1-1/2(38,10)/1-5/8(41,28)	1-1/2(38,10)/1-5/8(41,28)	1-1/2(38,10)/1-5/8(41,28)	1-1/2(38,10)/1-5/8(41,28)
	Balance pipe	Inch (mm)	1/4(6,35)	1/4(6,35)	1/4(6,35)	1/4(6,35)	1/4(6,35)	1/4(6,35)
Refrigerant (R410A)		kg/TCO ₂ Eq.	22,20/51,9912	24,90/51,9912	24,90/51,9912	24,90/51,9912	30,50/63,6840	33,20/69,3216
Maximum allowable indoor / outdoor capacity ratio % ³⁾			50 ~ 130(200)	50 ~ 130(200)	50 ~ 130(200)	50 ~ 130(200)	50 ~ 130(200)	50 ~ 130(200)
Operating range	Cool Min ~ Max	°C	-10 ~ +52	-10 ~ +52	-10 ~ +52	-10 ~ +52	-10 ~ +52	-10 ~ +52
	Heat Min ~ Max	°C	-25 ~ +18	-25 ~ +18	-25 ~ +18	-25 ~ +18	-25 ~ +18	-25 ~ +18

2-Pipe ECOi EX ME2 Series High Efficiency Model Combination from 54 to 64 HP

			54 HP	56 HP	58 HP	60 HP	62 HP	64 HP
			U-10ME2E8	U-12ME2E8	U-10ME2E8	U-12ME2E8	U-14ME2E8	U-16ME2E8
			U-12ME2E8	U-12ME2E8	U-16ME2E8	U-16ME2E8	U-16ME2E8	U-16ME2E8
			U-16ME2E8	U-16ME2E8	U-16ME2E8	U-16ME2E8	U-16ME2E8	U-16ME2E8
			U-16ME2E8	U-16ME2E8	U-16ME2E8	U-16ME2E8	U-16ME2E8	U-16ME2E8
Model name	U-10ME2E8							
	U-12ME2E8							
	U-16ME2E8							
Power supply	Voltage	V	380/400/415	380/400/415	380/400/415	380/400/415	380/400/415	380/400/415
	Phase		Three Phase	Three Phase	Three Phase	Three Phase	Three Phase	Three Phase
	Frequency	Hz	50	50	50	50	50	50
Cooling capacity		kW	151,00	156,00	162,00	168,00	174,00	180,00
EER ¹⁾		W/W	3,75	3,71	3,65	3,60	3,60	3,52
Running current cooling		A	63,20/60,90	65,30/63,00	69,70/67,10	73,30/70,60	75,80/73,00	80,30/77,40
Input power cooling		kW	40,30	42,10	44,40	46,70	48,30	51,20
Heating capacity		kW	169,00	175,00	182,00	189,00	195,00	201,00
COP ¹⁾		W/W	4,56	4,56	4,47	4,47	4,45	4,42
Running current heating		A	58,80/56,70	60,20/58,10	64,60/62,20	67,10/64,70	69,50/67,00	72,20/69,60
Input power heating		kW	37,10	38,40	40,70	42,30	43,80	45,50
Starting current		A	6,00	6,00	7,00	7,00	8,00	8,00
External static pressure (Max)		Pa	80	80	80	80	80	80
Air volume		m ³ /min	920	928	920	928	928	928
Sound pressure	Normal / Silent mode	dB(A)	66,00/63,00	66,50/63,50	66,50/63,50	67,00/64,00	67,00/64,00	67,00/64,00
Sound power	Normal mode	dB	87,00	87,50	87,50	88,00	88,00	88,00
Dimension / Net weight	H x W x D	mm / kg	1842 x 4490 x 1000/1110	1842 x 4900 x 1000/1170	1842 x 4490 x 1000/1155	1842 x 4900 x 1000/1215	1842 x 4900 x 1000/1260	1842 x 4900 x 1000/1260
Piping connections ²⁾	Liquid pipe	Inch (mm)	3/4(19,05)/7/8(22,22)	3/4(19,05)/7/8(22,22)	3/4(19,05)/7/8(22,22)	3/4(19,05)/7/8(22,22)	3/4(19,05)/7/8(22,22)	3/4(19,05)/7/8(22,22)
	Gas pipe	Inch (mm)	1-1/2(38,10)/1-5/8(41,28)	1-1/2(38,10)/1-5/8(41,28)	1-1/2(38,10)/1-5/8(41,28)	1-1/2(38,10)/1-5/8(41,28)	1-5/8(41,28)/1-3/4(44,45)	1-5/8(41,28)/1-3/4(44,45)
	Balance pipe	Inch (mm)	1/4(6,35)	1/4(6,35)	1/4(6,35)	1/4(6,35)	1/4(6,35)	1/4(6,35)
Refrigerant (R410A)		kg/TCO ₂ Eq.	30,50/63,6840	33,20/69,3216	30,50/63,6840	33,20/69,3216	33,20/69,3216	33,20/69,3216
Maximum allowable indoor / outdoor capacity ratio % ³⁾			50 ~ 130(200)	50 ~ 130(200)	50 ~ 130(200)	50 ~ 130(200)	50 ~ 130(200)	50 ~ 130(200)
Operating range	Cool Min ~ Max	°C	-10 ~ +52	-10 ~ +52	-10 ~ +52	-10 ~ +52	-10 ~ +52	-10 ~ +52
	Heat Min ~ Max	°C	-25 ~ +18	-25 ~ +18	-25 ~ +18	-25 ~ +18	-25 ~ +18	-25 ~ +18

Data is for reference. 1) EER and COP calculation is based in accordance to EN14511. 2) Pipe diameter under 90m for ultimate indoor unit / over 90m for ultimate indoor unit (if the longest piping equivalent length exceeds 90m, increase the sizes of the main tubes by 1 rank for gas tubes and liquid tubes). 3) If the following conditions are satisfied, the effective range is above 130 % and below 200 %: A. Obey the limited number of connectable indoor units. B. The lower limit of operating range for heating outdoor temperature is limited to -10 °C WB (standard -25 °C WB). C. Simultaneous operation is limited to less than 130 % of connectable indoor units.

SUPERIOR EFFICIENCY ECOi SERIES BY PANASONIC



The ever-evolving Panasonic ECOi Series

The ECOi Series is designed for energy savings, easy installation, and high efficiency. Always continuing to evolve, Panasonic uses advanced technologies to meet the requirements of diverse situations and contribute to the creation of comfortable living spaces. A game-changing VRF System delivering energy-saving performance, powerful operation, reliability and comfort surpassing anything previously possible.

Mini ECOi LE Series.

The new Mini ECOi system delivering energy-saving performance, powerful operation, reliability and comfort surpassing anything previously possible. Mini ECOi with extraordinary energy-saving performance and high external static pressure (35Pa).

2-Pipe ECOi EX ME2 Series.

More flexible piping length. Newly designed; compressor, oil recovery system, outdoor heat exchanger, allow system to increase piping length. The ECOi EX can still operate at 100 % capacity when the outside temperature is as high as 43 °C. This high power capability enables reliable operation even under extremely high temperature conditions.

New 3-Pipe ECOi EX MF3 Series.

3-Pipe ECOi EX has been newly developed by utilizing advanced technology of ECOi EX. Offering not only high-efficiency and great performance for simultaneous heating and cooling, but also HT (High Temperature) and LT (Low Temperature) water solution from heat recovery.

Mini ECOi LE Series



2-Pipe ECOi EX ME2 Series

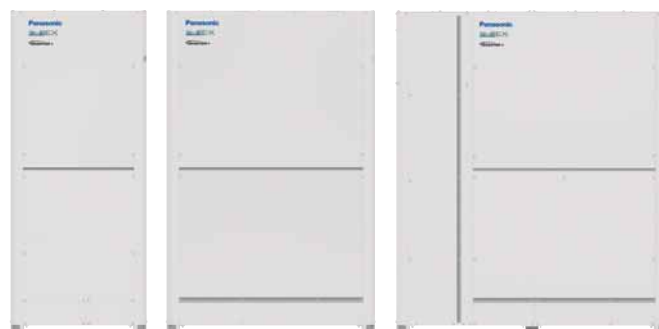

New 3-Pipe ECOi EX MF3 Series



NEW
18



2-Pipe ECOi EX ME2 Series Space Saving Model

			8 HP	10 HP	12 HP	14 HP	16 HP	18 HP	20 HP
Outdoor units			U-8ME2E8	U-10ME2E8	U-12ME2E8	U-14ME2E8	U-16ME2E8	U-18ME2E8	U-20ME2E8
Power supply	Voltage	V	380/400/415	380/400/415	380/400/415	380/400/415	380/400/415	380/400/415	380/400/415
	Phase		Three Phase	Three Phase	Three Phase	Three Phase	Three Phase	Three Phase	Three Phase
	Frequency	Hz	50	50	50	50	50	50	50
Cooling capacity	kW		22,40	28,00	33,50	40,00	45,00	50,00	56,00
EER ¹⁾	W/W		4,70	4,37	3,96	3,88	3,52	3,52	3,35
ESEER	W/W		9,33	8,67	7,94	7,73	7,19	6,95	6,18
SEER ²⁾	W/W		7,43	6,83	6,65	7,23	6,43	7,56	7,03
Running current cooling	A		7,40/7,14	10,20/9,80	13,00/12,50	16,50/15,90	20,10/19,40	22,00/21,20	25,40/24,50
Input power cooling	kW		4,77	6,41	8,47	10,30	12,80	14,20	16,70
Heating capacity	kW		25,00	31,50	37,50	45,00	50,00	56,00	63,00
COP ¹⁾	W/W		5,13	4,76	4,73	4,56	4,42	4,38	3,94
SCOP ²⁾	W/W		4,79	4,26	4,72	4,28	4,05	4,29	4,09
Running current heating	A		7,56/7,29	10,50/11,10	12,30/11,80	15,80/15,20	17,90/17,30	20,10/19,40	24,60/23,70
Input power heating	kW		4,87	6,62	7,92	9,86	11,30	12,80	16,00
Starting current	A		1,00	1,00	1,00	2,00	2,00	2,00	2,00
External static pressure (Max)	Pa		80	80	80	80	80	80	80
Air volume	m ³ /min		224	224	232	232	232	405	405
Sound pressure	Normal mode	dB(A)	54	56	59	60	61	59	60
	Silent mode	dB(A)	51	53	56	57	58	56	57
Sound power	Normal mode	dB	75	77	80	81	82	80	81
Dimension	HxWxD	mm	1842x770 x1000	1842x770 x1000	1842x1180 x1000	1842x1180 x1000	1842x1180 x1000	1842x1540 x1000	1842x1540 x1000
Net weight		kg	210	210	270	315	315	375	375
Piping connections ³⁾	Liquid pipe	Inch (mm)	3/8(9,52)/ 1/2(12,70)	3/8(9,52)/ 1/2(12,70)	1/2(12,70)/ 5/8(15,88)	1/2(12,70)/ 5/8(15,88)	1/2(12,70)/ 5/8(15,88)	5/8(15,88)/ 3/4(19,05)	5/8(15,88)/ 3/4(19,05)
	Gas pipe	Inch (mm)	3/4(19,05)/ 7/8(22,22)	7/8(22,22)/ 1(25,40)	1(25,40)/ 1-1/8(28,58)	1(25,40)/ 1-1/8(28,58)	1-1/8(28,58)/ 1-1/4(31,75)	1-1/8(28,58)/ 1-1/4(31,75)	1-1/8(28,58)/ 1-1/4(31,75)
	Balance pipe	Inch (mm)	1/4(6,35)	1/4(6,35)	1/4(6,35)	1/4(6,35)	1/4(6,35)	1/4(6,35)	1/4(6,35)
Refrigerant (R410A)	kg/TCO ₂ Eq.		5,60/11,6928	5,60/11,6928	8,30/17,3304	8,30/17,3304	8,30/17,3304	9,50/19,836	9,50/19,836
Maximum allowable indoor / outdoor capacity ratio % ⁴⁾			50 ~ 130 (200)	50 ~ 130 (200)	50 ~ 130 (200)	50 ~ 130 (200)	50 ~ 130 (200)	50 ~ 130 (200)	50 ~ 130 (200)
Operating range	Cool Min ~ Max	°C	-10 ~ +52	-10 ~ +52	-10 ~ +52	-10 ~ +52	-10 ~ +52	-10 ~ +52	-10 ~ +52
	Heat Min ~ Max	°C	-25 ~ +18	-25 ~ +18	-25 ~ +18	-25 ~ +18	-25 ~ +18	-25 ~ +18	-25 ~ +18

1) EER and COP calculation is based in accordance to EN14511. 2) SEER/SCOP is calculated based on the seasonal space cooling/heating efficiency "η" values of the COMMISSION REGULATION (EU) 2016/2281. SEER, SCOP = (η + Correction) × PEF. 3) Pipe diameter under 90m for ultimate indoor unit / over 90m for ultimate outdoor unit (if the longest piping equivalent length exceeds 90m, increase the sizes of the main tubes by 1 rank for gas tubes and liquid tubes). 4) If the following conditions are satisfied, the effective range is above 130 % and below 200 %: A. Obey the limited number of connectable indoor units. B. The lower limit of operating range for heating outdoor temperature is limited to -10 °C WB (standard -25 °C WB). C. Simultaneous operation is limited to less than 130 % of connectable indoor units.



2-Pipe ECOi EX ME2 Series Space Saving Model Combination from 22 to 34 HP

Model name			22 HP	24 HP	26 HP	28 HP	30 HP	32 HP	34 HP	
			U-10ME2E8	U-12ME2E8	U-10ME2E8	U-12ME2E8	U-14ME2E8	U-16ME2E8	U-16ME2E8	U-14ME2E8
			U-12ME2E8	U-12ME2E8	U-16ME2E8	U-16ME2E8	U-16ME2E8	U-16ME2E8	U-16ME2E8	U-20ME2E8
Power supply	Voltage	V	380/400/415	380/400/415	380/400/415	380/400/415	380/400/415	380/400/415	380/400/415	
	Phase		Three Phase	Three Phase	Three Phase	Three Phase	Three Phase	Three Phase	Three Phase	
	Frequency	Hz	50	50	50	50	50	50	50	
Cooling capacity	kW	61,50	68,00	73,00	78,50	85,00	90,00	96,00		
EER ¹⁾	W/W	4,13	3,93	3,80	3,69	3,68	3,52	3,56		
Running current cooling	A	23,10/22,30	26,60/25,60	30,10/29,00	33,10/31,90	36,60/35,30	40,20/38,70	41,90/40,40		
Input power cooling	kW	14,90	17,30	19,20	21,30	23,10	25,60	27,00		
Heating capacity	kW	69,00	76,50	81,50	87,50	95,00	100,00	108,00		
COP ¹⁾	W/W	4,76	4,69	4,55	4,56	4,48	4,42	4,17		
Running current heating	A	22,70/21,90	25,30/24,40	28,40/27,40	30,10/29,00	33,60/32,40	35,80/34,60	40,60/39,20		
Input power heating	kW	14,50	16,30	17,90	19,20	21,20	22,60	25,90		
Starting current	A	2,00	2,00	3,00	3,00	4,00	4,00	4,00		
External static pressure (Max)	Pa	80	80	80	80	80	80	80		
Air volume	m ³ /min	456	464	456	464	464	464	637		
Sound pressure	Normal / Silent mode	dB(A)	61,00/58,00	62,00/59,00	62,50/59,50	63,50/60,50	63,50/60,50	64,00/61,00	63,00/60,00	
Sound power	Normal mode	dB	82,00	83,00	83,50	84,50	84,50	85,00	84,00	
Dimension / Net weight	H x W x D	mm / kg	1842 x 2010 x 1000/480	1842 x 2420 x 1000/540	1842 x 2010 x 1000/525	1842 x 2420 x 1000/585	1842 x 2420 x 1000/630	1842 x 2420 x 1000/630	1842 x 2780 x 1000/690	
Piping connections ²⁾	Liquid pipe	Inch (mm)	5/8(15,88)/3/4(19,05)	5/8(15,88)/3/4(19,05)	3/4(19,05)/7/8(22,22)	3/4(19,05)/7/8(22,22)	3/4(19,05)/7/8(22,22)	3/4(19,05)/7/8(22,22)	3/4(19,05)/7/8(22,22)	
	Gas pipe	Inch (mm)	1-1/8(28,58)/1-1/4(31,75)	1-1/8(28,58)/1-1/4(31,75)	1-1/4(31,75)/1-1/2(38,10)	1-1/4(31,75)/1-1/2(38,10)	1-1/4(31,75)/1-1/2(38,10)	1-1/4(31,75)/1-1/2(38,10)	1-1/4(31,75)/1-1/2(38,10)	
	Balance pipe	Inch (mm)	1/4(6,35)	1/4(6,35)	1/4(6,35)	1/4(6,35)	1/4(6,35)	1/4(6,35)	1/4(6,35)	
Refrigerant (R410A)	kg/TCO ₂ Eq.	13,90/23,3856	16,60/34,6608	13,90/29,0232	16,60/34,6608	16,60/34,6608	16,60/34,6608	17,80/37,1664		
Maximum allowable indoor / outdoor capacity ratio % ³⁾		50 ~ 130(200)	50 ~ 130(200)	50 ~ 130(200)	50 ~ 130(200)	50 ~ 130(200)	50 ~ 130(200)	50 ~ 130(200)		
Operating range	Cool Min ~ Max	°C	-10 ~ +52	-10 ~ +52	-10 ~ +52	-10 ~ +52	-10 ~ +52	-10 ~ +52	-10 ~ +52	
	Heat Min ~ Max	°C	-25 ~ +18	-25 ~ +18	-25 ~ +18	-25 ~ +18	-25 ~ +18	-25 ~ +18	-25 ~ +18	

2-Pipe ECOi EX ME2 Series Space Saving Model Combination from 36 to 48 HP

Model name			36 HP	38 HP	40 HP	42 HP	44 HP	46 HP	48 HP
			U-16ME2E8	U-18ME2E8	U-20ME2E8	U-10ME2E8	U-12ME2E8	U-14ME2E8	U-16ME2E8
			U-20ME2E8	U-20ME2E8	U-20ME2E8	U-16ME2E8	U-16ME2E8	U-16ME2E8	U-16ME2E8
Power supply	Voltage	V	380/400/415	380/400/415	380/400/415	380/400/415	380/400/415	380/400/415	380/400/415
	Phase		Three Phase	Three Phase	Three Phase	Three Phase	Three Phase	Three Phase	Three Phase
	Frequency	Hz	50	50	50	50	50	50	50
Cooling capacity	kW	101,00	107,00	113,00	118,00	124,00	130,00	135,00	
EER ¹⁾	W/W	3,42	3,42	3,34	3,69	3,62	3,62	3,52	
Running current cooling	A	45,30/43,70	48,10/46,30	51,40/49,50	50,20/48,40	53,20/51,30	56,90/54,90	60,20/58,10	
Input power cooling	kW	25,9	31,3	33,8	32,0	34,3	35,9	38,4	
Heating capacity	kW	113,00	119,00	127,00	132,00	138,00	145,00	150,00	
COP ¹⁾	W/W	4,14	4,13	3,92	4,49	4,50	4,46	4,42	
Running current heating	A	42,40/40,80	44,70/43,10	49,80/48,00	46,60/44,90	48,20/46,40	51,50/49,70	53,80/51,80	
Input power heating	kW	27,30	28,80	32,40	29,40	30,70	32,50	33,90	
Starting current	A	4,00	4,00	4,00	5,00	5,00	6,00	6,00	
External static pressure (Max)	Pa	80	80	80	80	80	80	80	
Air volume	m ³ /min	637	810	810	688	696	696	696	
Sound pressure	Normal / Silent mode	dB(A)	63,50/60,50	62,50/59,50	63,00/60,00	65,00/62,00	65,50/62,50	65,50/62,50	66,00/63,00
Sound power	Normal mode	dB	84,50	83,50	84,00	86,00	86,50	86,50	87,00
Dimension / Net weight	H x W x D	mm / kg	1842 x 2780 x 1000/690	1842 x 3140 x 1000/750	1842 x 3140 x 1000/750	1842 x 3250 x 1000/840	1842 x 3660 x 1000/900	1842 x 3660 x 1000/945	1842 x 3660 x 1000/945
Piping connections ²⁾	Liquid pipe	Inch (mm)	3/4(19,05)/7/8(22,22)	3/4(19,05)/7/8(22,22)	3/4(19,05)/7/8(22,22)	3/4(19,05)/7/8(22,22)	3/4(19,05)/7/8(22,22)	3/4(19,05)/7/8(22,22)	3/4(19,05)/7/8(22,22)
	Gas pipe	Inch (mm)	1-1/2(38,10)/1-5/8(41,28)	1-1/2(38,10)/1-5/8(41,28)	1-1/2(38,10)/1-5/8(41,28)	1-1/2(38,10)/1-5/8(41,28)	1-1/2(38,10)/1-5/8(41,28)	1-1/2(38,10)/1-5/8(41,28)	1-1/2(38,10)/1-5/8(41,28)
	Balance pipe	Inch (mm)	1/4(6,35)	1/4(6,35)	1/4(6,35)	1/4(6,35)	1/4(6,35)	1/4(6,35)	1/4(6,35)
Refrigerant (R410A)	kg/TCO ₂ Eq.	17,80/37,1664	19,00/39,672	19,00/39,672	22,20/46,3536	24,90/51,9912	24,90/51,9912	24,90/51,9912	
Maximum allowable indoor / outdoor capacity ratio % ³⁾		50 ~ 130(200)	50 ~ 130(200)	50 ~ 130(200)	50 ~ 130(200)	50 ~ 130(200)	50 ~ 130(200)	50 ~ 130(200)	
Operating range	Cool Min ~ Max	°C	-10 ~ +52	-10 ~ +52	-10 ~ +52	-10 ~ +52	-10 ~ +52	-10 ~ +52	-10 ~ +52
	Heat Min ~ Max	°C	-25 ~ +18	-25 ~ +18	-25 ~ +18	-25 ~ +18	-25 ~ +18	-25 ~ +18	-25 ~ +18

1) EER and COP calculation is based in accordance to EN14511. 2) Pipe diameter under 90m for ultimate indoor unit / over 90m for ultimate indoor unit (if the longest piping equivalent length exceeds 90m, increase the sizes of the main tubes by 1 rank for gas tubes and liquid tubes). 3) If the following conditions are satisfied, the effective range is above 130 % and below 200 %: A. Obey the limited number of connectable indoor units. B. The lower limit of operating range for heating outdoor temperature is limited to -10 °C WB (standard -25 °C WB). C. Simultaneous operation is limited to less than 130 % of connectable indoor units.

2-Pipe ECOi EX ME2 Series Space Saving Model Combination from 50 to 64 HP

			50 HP	52 HP	54 HP	56 HP	58 HP	60 HP	62 HP	64 HP
			U-14ME2E8	U-16ME2E8	U-14ME2E8	U-16ME2E8	U-18ME2E8	U-20ME2E8	U-14ME2E8	U-16ME2E8
Model name			U-16ME2E8	U-16ME2E8	U-20ME2E8	U-20ME2E8	U-20ME2E8	U-20ME2E8	U-16ME2E8	U-16ME2E8
			U-20ME2E8	U-20ME2E8	U-20ME2E8	U-20ME2E8	U-20ME2E8	U-20ME2E8	U-16ME2E8	U-16ME2E8
Power supply	Voltage	V	380/400/415	380/400/415	380/400/415	380/400/415	380/400/415	380/400/415	380/400/415	380/400/415
	Phase		Three Phase	Three Phase	Three Phase	Three Phase	Three Phase	Three Phase	Three Phase	Three Phase
	Frequency	Hz	50	50	50	50	50	50	50	50
Cooling capacity		kW	140,00	145,00	151,00	156,00	162,00	168,00	174,00	180,00
EER ¹⁾		W/W	3,55	3,46	3,49	3,41	3,40	3,35	3,60	3,52
Running current cooling		A	61,10/58,90	65,00/62,70	66,50/64,10	70,30/67,80	73,10/70,40	76,10/73,40	75,80/73,00	80,30/77,40
Input power cooling		kW	39,40	41,90	43,30	45,80	47,60	50,10	48,30	51,20
Heating capacity		kW	155,00	160,00	169,00	175,00	182,00	189,00	195,00	201,00
COP ¹⁾		W/W	4,29	4,27	4,11	4,08	4,06	3,94	4,45	4,42
Running current heating		A	56,60/54,60	58,80/56,70	63,80/61,50	66,60/64,20	69,50/67,00	73,70/71,00	69,50/67,00	72,20/69,60
Input power heating		kW	36,10	37,50	41,10	42,90	44,80	48,00	43,80	45,50
Starting current		A	6,00	6,00	6,00	6,00	6,00	6,00	8,00	8,00
External static pressure (Max)		Pa	80	80	80	80	80	80	80	80
Air volume		m ³ /min	869	869	1042	1042	1215	1215	928	928
Sound pressure	Normal / Silent mode	dB(A)	65,50/62,50	65,50/62,50	65,00/62,00	65,50/62,50	64,50/61,50	65,00/62,00	67,00/64,00	67,00/64,00
Sound power	Normal mode	dB	86,50	86,50	86,00	86,50	85,50	86,00	88,00	88,00
Dimension / Net weight	HxWxD	mm / kg	1842x4020x1000/1005	1842x4020x1000/1005	1842x4380x1000/1065	1842x4380x1000/1065	1842x4740x1000/1125	1842x4740x1000/1125	1842x4900x1000/1260	1842x4900x1000/1260
	Liquid pipe	Inch (mm)	3/4(19,05)/7/8(22,22)	3/4(19,05)/7/8(22,22)	3/4(19,05)/7/8(22,22)	3/4(19,05)/7/8(22,22)	3/4(19,05)/7/8(22,22)	3/4(19,05)/7/8(22,22)	3/4(19,05)/7/8(22,22)	3/4(19,05)/7/8(22,22)
Piping connections ²⁾	Gas pipe	Inch (mm)	1-1/2(38,10)/1-5/8(41,28)	1-1/2(38,10)/1-5/8(41,28)	1-1/2(38,10)/1-5/8(41,28)	1-1/2(38,10)/1-5/8(41,28)	1-1/2(38,10)/1-5/8(41,28)	1-1/2(38,10)/1-5/8(41,28)	1-5/8(41,28)/1-3/4(44,45)	1-5/8(41,28)/1-3/4(44,45)
	Balance pipe	Inch (mm)	1/4(6,35)	1/4(6,35)	1/4(6,35)	1/4(6,35)	1/4(6,35)	1/4(6,35)	1/4(6,35)	1/4(6,35)
Refrigerant (R410A)		kg/TCO ₂ Eq.	26,10/54,4968	26,10/54,4968	27,30/57,0024	27,30/57,0024	28,50/59,508	28,50/59,508	33,20/69,3216	33,20/69,3216
Maximum allowable indoor / outdoor capacity ratio % ³⁾			50 ~ 130(200)	50 ~ 130(200)	50 ~ 130(200)	50 ~ 130(200)	50 ~ 130(200)	50 ~ 130(200)	50 ~ 130(200)	50 ~ 130(200)
Operating range	Cool Min ~ Max	°C	-10 ~ +52	-10 ~ +52	-10 ~ +52	-10 ~ +52	-10 ~ +52	-10 ~ +52	-10 ~ +52	-10 ~ +52
	Heat Min ~ Max	°C	-25 ~ +18	-25 ~ +18	-25 ~ +18	-25 ~ +18	-25 ~ +18	-25 ~ +18	-25 ~ +18	-25 ~ +18

2-Pipe ECOi EX ME2 Series Space Saving Model Combination from 66 to 80 HP

			66 HP	68 HP	70 HP	72 HP	74 HP	76 HP	78 HP	80 HP
			U-10ME2E8	U-12ME2E8	U-10ME2E8	U-16ME2E8	U-16ME2E8	U-16ME2E8	U-18ME2E8	U-20ME2E8
Model name			U-16ME2E8	U-16ME2E8	U-20ME2E8	U-16ME2E8	U-18ME2E8	U-20ME2E8	U-20ME2E8	U-20ME2E8
			U-20ME2E8	U-20ME2E8	U-20ME2E8	U-20ME2E8	U-20ME2E8	U-20ME2E8	U-20ME2E8	U-20ME2E8
			U-20ME2E8	U-20ME2E8	U-20ME2E8	U-20ME2E8	U-20ME2E8	U-20ME2E8	U-20ME2E8	U-20ME2E8
Power supply	Voltage	V	380/400/415	380/400/415	380/400/415	380/400/415	380/400/415	380/400/415	380/400/415	380/400/415
	Phase		Three Phase	Three Phase	Three Phase	Three Phase	Three Phase	Three Phase	Three Phase	Three Phase
	Frequency	Hz	50	50	50	50	50	50	50	50
Cooling capacity		kW	185,00	190,00	196,00	202,00	208,00	213,00	219,00	224,00
EER ¹⁾		W/W	3,52	3,49	3,47	3,42	3,42	3,39	3,38	3,35
Running current cooling		A	80,80/77,80	83,70/80,70	86,80/83,60	90,60/87,30	93,40/90,00	96,60/93,10	98,30/94,70	101,50/97,80
Input power cooling		kW	52,60	54,50	56,50	59,00	60,80	62,90	64,70	66,80
Heating capacity		kW	207,00	213,00	219,00	226,00	233,00	239,00	245,00	252,00
COP ¹⁾		W/W	4,16	4,18	4,05	4,14	4,12	4,03	4,03	3,94
Running current heating		A	77,10/74,30	79,20/76,30	83,10/80,10	84,70/81,70	87,70/84,50	92,00/88,70	93,40/90,00	98,30/94,70
Input power heating		kW	49,70	51,00	54,10	54,60	56,50	59,30	60,80	64,00
Starting current		A	7,00	7,00	7,00	8,00	8,00	8,00	8,00	8,00
External static pressure (Max)		Pa	80	80	80	80	80	80	80	80
Air volume		m ³ /min	1266	1274	1439	1274	1447	1447	1620	1620
Sound pressure	Normal / Silent mode	dB(A)	66,00/63,00	66,50/63,50	65,50/62,50	66,50/63,50	66,50/63,50	66,50/63,50	66,00/63,00	66,00/63,00
Sound power	Normal mode	dB	87,00	87,50	86,50	87,50	87,50	87,50	87,00	87,00
Dimension / Net weight	HxWxD	mm / kg	1842x5210x1000/1275	1842x5620x1000/1335	1842x5570x1000/1335	1842x5620x1000/1380	1842x5980x1000/1440	1842x5980x1000/1440	1842x6340x1000/1500	1842x6340x1000/1500
	Liquid pipe	Inch (mm)	3/4(19,05)/7/8(22,22)	7/8(22,22)/1(25,04)	7/8(22,22)/1(25,04)	7/8(22,22)/1(25,04)	7/8(22,22)/1(25,04)	7/8(22,22)/1(25,04)	7/8(22,22)/1(25,04)	7/8(22,22)/1(25,04)
Piping connections ²⁾	Gas pipe	Inch (mm)	1-5/8(41,28)/1-3/4(44,45)	1-5/8(41,28)/1-3/4(44,45)	1-5/8(41,28)/1-3/4(44,45)	1-3/4(44,45)/2(50,80)	1-3/4(44,45)/2(50,80)	1-3/4(44,45)/2(50,80)	1-3/4(44,45)/2(50,80)	1-3/4(44,45)/2(50,80)
	Balance pipe	Inch (mm)	1/4(6,35)	1/4(6,35)	1/4(6,35)	1/4(6,35)	1/4(6,35)	1/4(6,35)	1/4(6,35)	1/4(6,35)
Refrigerant (R410A)		kg/TCO ₂ Eq.	32,90/68,6952	35,60/74,3328	34,10/19,836	35,80/68,6952	36,80/19,836	36,80/76,8384	38,00/79,344	38,00/79,344
Maximum allowable indoor / outdoor capacity ratio % ³⁾			50 ~ 130(200)	50 ~ 130(200)	50 ~ 130(200)	50 ~ 130(200)	50 ~ 130(200)	50 ~ 130(200)	50 ~ 130(200)	50 ~ 130(200)
Operating range	Cool Min ~ Max	°C	-10 ~ +52	-10 ~ +52	-10 ~ +52	-10 ~ +52	-10 ~ +52	-10 ~ +52	-10 ~ +52	-10 ~ +52
	Heat Min ~ Max	°C	-25 ~ +18	-25 ~ +18	-25 ~ +18	-25 ~ +18	-25 ~ +18	-25 ~ +18	-25 ~ +18	-25 ~ +18

1) EER and COP calculation is based in accordance to EN14511. 2) Pipe diameter under 90m for ultimate indoor unit / over 90m for ultimate indoor unit (if the longest piping equivalent length exceeds 90m, increase the sizes of the main tubes by 1 rank for gas tubes and liquid tubes). 3) If the following conditions are satisfied, the effective range is above 130 % and below 200 %: A. Obey the limited number of connectable indoor units. B. The lower limit of operating range for heating outdoor temperature is limited to -10 °C WB (standard -25 °C WB). C. Simultaneous operation is limited to less than 130 % of connectable indoor units.

NEW 3-PIPE ECOi EX MF3 SERIES



Simultaneous heating and cooling VRF System

The New Panasonic 3-Pipe MF3 series offers the ideal solution to meet customer's demand.

Upgraded energy efficiency utilized ECOi EX technology.

- SEER / SCOP improved in full capacities from 8 to 16 HP
- SEER / SCOP follows LOT21 started from January 2018
- EER / COP is certified in Eurovent

Design flexibility.

- High reliability even under tough temperature condition
- Maximum 52 indoor units connectable
- Slim heat recovery box with just 200 height
- Farthest piping length between indoor units and outdoor units: 200m

Excellent seasonal energy saving.

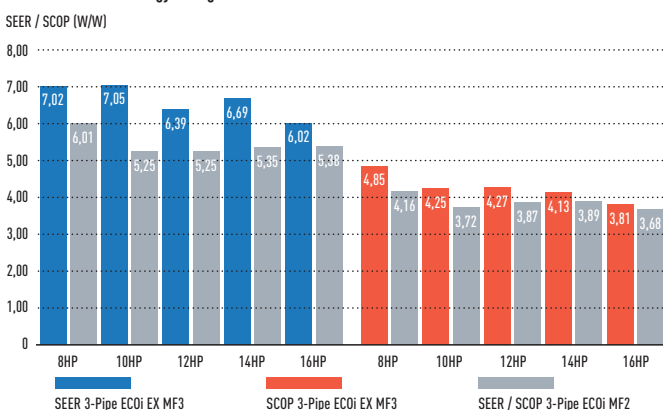

Extended design operation conditions

Cooling design operation conditions: The cooling operation range has been extended to -10 °C ~ 52 °C by changing the outdoor fan to an Inverter type.

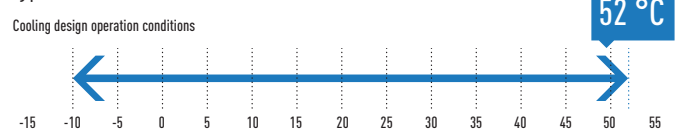

Cooling: Outside air temperature °C DB. Heating: Outside air temperature °C (WB).

Heating design operation conditions: Stable heating operation even with an outside air temperature of -20 °C. The heating operation range has been extended to -20 °C by use of a compressor with a high-pressure vessel.

Wide temperature setting range

Wired remote control heating temperature setting range is 16 to 30 °C.

NEW
184,85
SCOP

NEW 3-Pipe ECOi EX MF3 Series

			8 HP	10 HP	12 HP	14 HP	16 HP
Outdoor Units			U-8MF3E8	U-10MF3E8	U-12MF3E8	U-14MF3E8	U-16MF3E8
Power supply	Voltage	V	380/400/415	380/400/415	380/400/415	380/400/415	380/400/415
	Phase		Three Phase	Three Phase	Three Phase	Three Phase	Three Phase
	Frequency	Hz	50	50	50	50	50
Cooling capacity		kW	22,40	28,00	33,50	40,00	45,00
EER ¹⁾		W/W	5,11	4,72	3,91	3,70	3,49
SEER ²⁾		W/W	7,02	7,05	6,39	6,69	6,02
Running current cooling		A	7,16/6,80/6,55	9,90/9,41/9,07	3,19/13,20/12,70	18,20/17,30/16,70	21,30/20,20/19,50
Input power cooling		kW	4,38	5,93	8,57	10,80	12,90
Heating capacity		kW	25,00	31,50	37,50	45,00	50,00
COP ¹⁾		W/W	5,25	5,17	4,51	4,21	4,17
SCOP ²⁾		W/W	4,85	4,25	4,27	4,13	3,81
Running current heating		A	7,78/7,39/7,12	10,20/9,66/9,31	13,40/12,80/12,30	18,10/17,20/16,50	20,00/19,00/18,30
Input power heating		kW	4,76	6,09	8,32	10,70	12,00
Starting current		A	1,00	1,00	1,00	2,00	2,00
External static pressure (Max)		Pa	80	80	80	80	80
Air volume		m/min	210	220	232	232	232
Sound pressure	Normal mode	dB(A)	54,00	57,00	60,00	61,00	62,00
	Silent mode 1 / 2	dB(A)	51,00/49,00	54,00/52,00	57,00/55,00	58,00/56,00	59,00/57,00
Sound power	Normal mode	dB	76,00	78,00	81,00	82,00	82,00
Dimension	H x W x D	mm	1842 x 1180 x 1000	1842 x 1180 x 1000	1842 x 1180 x 1000	1842 x 1180 x 1000	1842 x 1180 x 1000
Net weight		kg	261	262	286	334	334
Piping connections ³⁾	Liquid pipe	Inch (mm)	3/8(9,52)/1/2(12,70)	3/8(9,52)/1/2(12,70)	1/2(12,70)/5/8(15,88)	1/2(12,70)/5/8(15,88)	1/2(12,70)/5/8(15,88)
	Discharge pipe	Inch (mm)	5/8(15,88)/3/4(19,05)	3/4(19,05)/7/8(22,22)	3/4(19,05)/7/8(22,22)	7/8(22,22)/1(25,40)	7/8(22,22)/1(25,40)
	Suction pipe	Inch (mm)	3/4(19,05)/7/8(22,22)	7/8(22,22)/1(25,40)	1(25,40)/1-1/8(28,58)	1(25,40)/1-1/8(28,58)	1-1/8(28,58)/1-1/4(31,75)
	Balance pipe	Inch (mm)	1/4(6,35)	1/4(6,35)	1/4(6,35)	1/4(6,35)	1/4(6,35)
Refrigerant (R410A)		kg / TCO ₂ Eq.	6,80/14,1984	6,80/14,1984	8,30/17,3304	8,30/17,3304	8,30/17,3304
Maximum allowable indoor / outdoor capacity ratio %			50 ~ 150	50 ~ 150	50 ~ 150	50 ~ 150	50 ~ 150
Operating range	Cool Min ~ Max	°C	-10 ~ +52	-10 ~ +52	-10 ~ +52	-10 ~ +52	-10 ~ +52
	Heat Min ~ Max	°C	-20 ~ +18	-20 ~ +18	-20 ~ +18	-20 ~ +18	-20 ~ +18
	Simultaneous op.	°C	-10 ~ +24	-10 ~ +24	-10 ~ +24	-10 ~ +24	-10 ~ +24

Solenoid valve kit

KIT-P56HR3	KIT-P56HR3	3-Pipe control Solenoid valve kit (up to 5,60 kW)
	CZ-P56HR3	Solenoid valve kit (up to 5,60 kW)
	CZ-CAPE2	3-Pipe control PCB
KIT-P160HR3	KIT-P160HR3	3-Pipe control Solenoid valve kit (from 5,6 to 10,60 kW)
	CZ-P160HR3	Solenoid valve kit (up to 16,00 kW)
	CZ-CAPE2	3-Pipe control PCB
CZ-CAPEK2		3-Pipe control PCB for wall mounted

3-Pipe control box kit

CZ-P456HR3	4 ports 3 pipe box (up to 5,60 kW)
CZ-P656HR3	6 ports 3 pipe box (up to 5,60 kW)
CZ-P856HR3	8 ports 3 pipe box (up to 5,60 kW)
CZ-P4160HR3	4 ports 3 pipe box (up to 16,00 kW)

1) EER and COP calculation is based in accordance to EN14511. 2) SEER/SCOP is calculated based on the seasonal space cooling/heating efficiency "η₁" values of the COMMISSION REGULATION (EU) 2016/2281. SEER, SCOP = (η₁ + Correction) × PEF. 3) Pipe diameter under 90m for ultimate indoor unit / over 90m for ultimate indoor unit (if the longest piping equivalent length exceeds 90m, increase the sizes of the main tubes by 1 rank for gas tubes and liquid tubes).



NEW 3-Pipe ECOi EX MF3 Series Combination from 18 to 32 HP

HP			18 HP	20 HP	22 HP	24 HP	26 HP	28 HP	30 HP	32 HP
Model name			U-8MF3E8	U-8MF3E8	U-10MF3E8	U-12MF3E8	U-10MF3E8	U-12MF3E8	U-14MF3E8	U-16MF3E8
			U-10MF3E8	U-12MF3E8	U-12MF3E8	U-12MF3E8	U-16MF3E8	U-16MF3E8	U-16MF3E8	U-16MF3E8
Power supply	Voltage	V	380/400/415	380/400/415	380/400/415	380/400/415	380/400/415	380/400/415	380/400/415	380/400/415
	Phase		Three Phase	Three Phase	Three Phase	Three Phase	Three Phase	Three Phase	Three Phase	Three Phase
	Frequency	Hz	50	50	50	50	50	50	50	50
Cooling capacity	kW		50,00	56,00	61,50	68,00	73,00	78,50	85,00	90,00
EER ¹⁾	W/W		4,90	4,31	4,24	3,89	3,88	3,65	3,59	3,49
Running current cooling	A		16,80/16,00/15,40	21,00/20,00/19,20	23,70/22,50/21,70	28,30/26,90/25,90	31,00/29,50/28,40	35,10/33,40/32,20	39,60/37,60/36,20	42,60/40,50/39,00
Input power cooling	kW		10,20	13,00	14,50	17,50	18,80	21,50	23,70	25,8
Heating capacity	kW		56,00	63,00	69,00	76,50	81,50	87,50	95,00	100,00
COP ¹⁾	W/W		5,23	4,77	4,79	4,47	4,50	4,31	4,19	4,17
Running current heating	A		17,70/16,80/16,20	21,30/20,30/19,50	23,50/22,30/21,50	27,60/26,30/25,30	30,20/28,70/27,70	33,50/31,80/30,70	37,90/36,00/34,70	40,10/38,10/36,70
Input power heating	kW		10,70	13,20	14,40	17,10	18,10	20,30	22,70	24,00
Starting current			2,00	2,00	2,00	2,00	3,00	3,00	4,00	4,00
External static pressure (Max)			80	80	80	80	80	80	80	80
Air volume	m ³ /min		430	442	452	464	452	464	464	464
Sound pressure	Normal mode	dB(A)	59,00	61,00	62,00	63,00	63,50	64,50	64,50	65,00
	Silent mode 1 / 2	dB(A)	56,00/54,00	58,00/56,00	59,00/57,00	60,00/58,00	60,50/58,50	61,50/59,50	61,50/59,50	62,00/60,00
Sound power	Normal mode	dB	81,50	84,00	84,50	86,00	84,50	86,00	86,00	86,00
Dimension	H x W x D	mm	1842 x 2360 (+60) x 1000	1842 x 2360 (+60) x 1000	1842 x 2360 (+60) x 1000	1842 x 2360 (+60) x 1000	1842 x 2360 (+60) x 1000	1842 x 2360 (+60) x 1000	1842 x 2360 (+60) x 1000	1842 x 2360 (+60) x 1000
Net weight	kg		523	547	548	574	596	620	668	668
Piping connections ²⁾	Liquid pipe	Inch (mm)	5/8(15,88)/ 3/4(19,05)	5/8(15,88)/ 3/4(19,05)	5/8(15,88)/ 3/4(19,05)	5/8(15,88)/ 3/4(19,05)	3/4(19,05)/ 7/8(22,22)	3/4(19,05)/ 7/8(22,22)	3/4(19,05)/ 7/8(22,22)	3/4(19,05)/ 7/8(22,22)
	Discharge pipe	Inch (mm)	7/8(22,22)/ 1(25,40)	7/8(22,22)/ 1(25,40)	1(25,40)/ 1-1/8(28,58)	1(25,40)/ 1-1/8(28,58)	1(25,40)/ 1-1/8(28,58)	1-1/8(28,58)/ 1-1/4(31,75)	1-1/8(28,58)/ 1-1/4(31,75)	1-1/8(28,58)/ 1-1/4(31,75)
	Suction pipe	Inch (mm)	1-1/8(28,58)/ 1-1/4(31,75)	1-1/8(28,58)/ 1-1/4(31,75)	1-1/8(28,58)/ 1-1/4(31,75)	1-1/8(28,58)/ 1-1/4(31,75)	1-1/4(31,75)/ 1-1/2(38,10)	1-1/4(31,75)/ 1-1/2(38,10)	1-1/4(31,75)/ 1-1/2(38,10)	1-1/4(31,75)/ 1-1/2(38,10)
	Balance pipe	Inch (mm)	1/4(6,35)	1/4(6,35)	1/4(6,35)	1/4(6,35)	1/4(6,35)	1/4(6,35)	1/4(6,35)	1/4(6,35)
Refrigerant (R410A)	kg/TCO ₂ Eq.		13,60/28,3968	15,10/31,5288	15,10/31,5288	16,60/34,6608	15,10/31,5288	16,60/34,6608	16,60/34,6608	16,60/34,6608
Maximum allowable indoor / outdoor capacity ratio %			50 ~ 150	50 ~ 150	50 ~ 150	50 ~ 150	50 ~ 150	50 ~ 150	50 ~ 150	50 ~ 150
Operating range	Cool Min ~ Max	°C	-10 ~ +52	-10 ~ +52	-10 ~ +52	-10 ~ +52	-10 ~ +52	-10 ~ +52	-10 ~ +52	-10 ~ +52
	Heat Min ~ Max	°C	-20 ~ +18	-20 ~ +18	-20 ~ +18	-20 ~ +18	-20 ~ +18	-20 ~ +18	-20 ~ +18	-20 ~ +18
	Simultaneous op.	°C	-10 ~ +24	-10 ~ +24	-10 ~ +24	-10 ~ +24	-10 ~ +24	-10 ~ +24	-10 ~ +24	-10 ~ +24

NEW 3-Pipe ECOi EX MF3 Series Combination from 34 to 48 HP

HP			34 HP	36 HP	38 HP	40 HP	42 HP	44 HP	46 HP	48 HP
Model name			U-8MF3E8	U-8MF3E8	U-10MF3E8	U-8MF3E8	U-10MF3E8	U-12MF3E8	U-14MF3E8	U-16MF3E8
			U-10MF3E8	U-12MF3E8	U-12MF3E8	U-16MF3E8	U-16MF3E8	U-16MF3E8	U-16MF3E8	U-16MF3E8
Power supply	Voltage	V	380/400/415	380/400/415	380/400/415	380/400/415	380/400/415	380/400/415	380/400/415	380/400/415
	Phase		Three Phase	Three Phase	Three Phase	Three Phase	Three Phase	Three Phase	Three Phase	Three Phase
	Frequency	Hz	50	50	50	50	50	50	50	50
Cooling capacity	kW		96,00	101,00	107,00	113,00	118,00	124,00	130,00	135,00
EER ¹⁾	W/W		4,10	3,90	3,88	3,72	3,72	3,58	3,55	3,49
Running current cooling	A		38,60/36,70/35,40	42,30/40,20/38,70	45,60/43,30/41,70	50,20/47,70/46,00	52,40/49,70/47,90	56,50/53,70/51,80	61,10/58,10/56,00	63,90/60,70/58,50
Input power cooling	kW		23,40	25,90	27,60	30,40	31,70	34,60	36,60	38,70
Heating capacity	kW		108,00	113,00	119,00	127,00	132,00	138,00	145,00	150,00
COP ¹⁾	W/W		4,64	4,48	4,51	4,31	4,36	4,25	4,18	4,17
Running current heating	A		38,90/37,00/35,60	41,60/39,50/38,10	43,60/41,40/39,90	49,30/46,80/45,10	50,60/48,10/46,30	53,70/51,00/49,10	57,90/55,00/53,00	60,10/57,10/55,00
Input power heating	kW		23,30	25,20	26,40	29,50	30,30	32,50	34,70	36,00
Starting current			4,00	4,00	4,00	5,00	5,00	5,00	6,00	6,00
External static pressure (Max)			80	80	80	80	80	80	80	80
Air volume	m ³ /min		662	674	684	674	684	696	696	696
Sound pressure	Normal mode	dB(A)	64,00	64,50	65,00	65,50	66,00	66,50	66,50	67,00
	Silent mode 1 / 2	dB(A)	61,00/59,00	61,50/59,50	62,00/60,00	62,50/60,50	63,00/61,00	63,50/61,50	63,50/61,50	64,00/62,00
Sound power	Normal mode	dB	84,50	85,50	85,50	85,50	86,00	86,50	87,00	87,00
Dimension	H x W x D	mm	1842 x 3540 (+120) x 1000	1842 x 3540 (+120) x 1000	1842 x 3540 (+120) x 1000	1842 x 3540 (+120) x 1000	1842 x 3540 (+120) x 1000	1842 x 3540 (+120) x 1000	1842 x 3540 (+120) x 1000	1842 x 3540 (+120) x 1000
Net weight	kg		857	881	882	929	930	954	1002	1002
Piping connections ²⁾	Liquid pipe	Inch (mm)	3/4(19,05)/ 7/8(22,22)	3/4(19,05)/ 7/8(22,22)	3/4(19,05)/ 7/8(22,22)	3/4(19,05)/ 7/8(22,22)	3/4(19,05)/ 7/8(22,22)	3/4(19,05)/ 7/8(22,22)	3/4(19,05)/ 7/8(22,22)	3/4(19,05)/ 7/8(22,22)
	Discharge pipe	Inch (mm)	1-1/8(28,58)/ 1-1/4(31,75)	1-1/8(28,58)/ 1-1/4(31,75)	1-1/4(31,75)/ 1-1/2(38,10)	1-1/4(31,75)/ 1-1/2(38,10)	1-1/4(31,75)/ 1-1/2(38,10)	1-1/4(31,75)/ 1-1/2(38,10)	1-1/4(31,75)/ 1-1/2(38,10)	1-1/4(31,75)/ 1-1/2(38,10)
	Suction pipe	Inch (mm)	1-1/4(31,75)/ 1-1/2(38,10)	1-1/2(38,10)/ 1-5/8(41,28)	1-1/2(38,10)/ 1-5/8(41,28)	1-1/2(38,10)/ 1-5/8(41,28)	1-1/2(38,10)/ 1-5/8(41,28)	1-1/2(38,10)/ 1-5/8(41,28)	1-1/2(38,10)/ 1-5/8(41,28)	1-1/2(38,10)/ 1-5/8(41,28)
	Balance pipe	Inch (mm)	1/4(6,35)	1/4(6,35)	1/4(6,35)	1/4(6,35)	1/4(6,35)	1/4(6,35)	1/4(6,35)	1/4(6,35)
Refrigerant (R410A)	kg/TCO ₂ Eq.		21,90/45,72719	23,40/48,85919	23,40/48,85919	23,40/48,85919	23,40/48,85919	24,90/46,3536	24,90/51,9912	24,90/51,9912
Maximum allowable indoor / outdoor capacity ratio %			50 ~ 150	50 ~ 150	50 ~ 150	50 ~ 150	50 ~ 150	50 ~ 150	50 ~ 150	50 ~ 150
Operating range	Cool Min ~ Max	°C	-10 ~ +52	-10 ~ +52	-10 ~ +52	-10 ~ +52	-10 ~ +52	-10 ~ +52	-10 ~ +52	-10 ~ +52
	Heat Min ~ Max	°C	-20 ~ +18	-20 ~ +18	-20 ~ +18	-20 ~ +18	-20 ~ +18	-20 ~ +18	-20 ~ +18	-20 ~ +18
	Simultaneous op.	°C	-10 ~ +24	-10 ~ +24	-10 ~ +24	-10 ~ +24	-10 ~ +24	-10 ~ +24	-10 ~ +24	-10 ~ +24

1) EER and COP calculation is based in accordance to EN14511. 2) Pipe diameter under 90m for ultimate indoor unit / over 90m for ultimate indoor unit (if the longest piping equivalent length exceeds 90m, increase the sizes of the main tubes by 1 rank for gas tubes and liquid tubes).

THE SOLUTION FOR CHILLED AND HOT WATER PRODUCTION!



NYHET
18

**A CLASS
WATER
PUMP
INCLUDED**

NEW 2-Pipe ECOi EX with Water Heat Exchanger for chilled and hot water production

Hydrokit with A class water pump		PAW-250WP5G	PAW-500WP5G
Hydrokit without pump		PAW-250W5G	PAW-500W5G
Cooling capacity at 35°C, water outlet 7°C	kW	25,00	50,00
Heating capacity	kW	28,00	56,00
Heating capacity at +7°C, heating water temperature at 45°C	kW	28,00	56,00
COP at +7°C with heating water temperature at 45°C	W/W	2,97	3,10
Heating Energy Efficiency class at 35°C¹⁾		A+	A++
η_{sh} (LOT21) ²⁾	%	164,00	158,00
Dimension	H x W x D	mm	1000 x 575 x 1110
Net weight		kg	135 (140 with pump)
Water pipe connector			Rp2 Female Thread (50A)
Heating water flow ($\Delta T=5$ K, 35°C)	m ³ /h	5,16	10,32
Capacity of integrated electric heater	kW	Not equipped	Not equipped
Flow switch		Equipped	Equipped
Water filter		Equipped	Equipped
Input power	kW	0,329 (with A class water pump) / 0,024 (without pump)	0,574 (with A class water pump) / 0,024 (without pump)
Maximum current	A	1,43 (with A class water pump) / 0,10 (without pump)	2,50 (with A class water pump) / 0,10 (without pump)
Outdoor unit		U-10ME2E8	U-20ME2E8
Sound pressure		dB(A)	56
Dimension	H x W x D	mm	1842 x 770 x 1000
Net weight		kg	210
Piping connections	Liquid pipe	Inch (mm)	3/8 (9,52)
	Gas pipe	Inch (mm)	7/8 (22,22)
Refrigerant (R410A)		kg	5,6 *Need Additional gas amount at site
Pipe length range / Elevation difference (in/out)		m	170 / 50 (OD above) 35 (OD below)
Pipe length for nominal capacity		m	7,5
Pipe length for additional gas / Additional gas amount (R410A)		m / g/m	0 < / Refer to manual
Operation range	Heat Min - Max	°C	-11 ~ +15 ³⁾
Water outlet temperature range	Cool Min - Max	°C	+5 ~ +15
	Heat Min - Max	°C	+35 ~ +45

1) Unit efficiency energy level: Scale from A++ to G. 2) Seasonal space cooling/heating energy efficiency following COMMISSION REGULATION (EU) 813/2013. 3) With accessory low temperature kit -25 ~ +15°C.

Performance calculation in agreement with Eurovent. Sound pressure measured at 1m from the outdoor unit and at 1,5m height.

Accessories

PAW-3WSK Stacking kit for vertical stacking (4 sets in the Kit)

ECOi from 28 kW to 50 kW

Key benefits:

- No cascade installation up to 51,30 kW
- Full line-up of outdoor units which can cover up to 63 kW heat demand
- Large choice of remote controls and interfaces
- 3,10 COP with water at 45 °C and outdoor temperature of +7 °C

With ECOi outdoor units

- Maximum hot water outlet temperature: 45 °C
- Minimum chilled water outlet temperature: 5 °C
- Outdoor temperature range in cooling mode: +5 °C to +43 °C
- Outdoor temperature range in heating mode: -11 °C to +15 °C

System example.

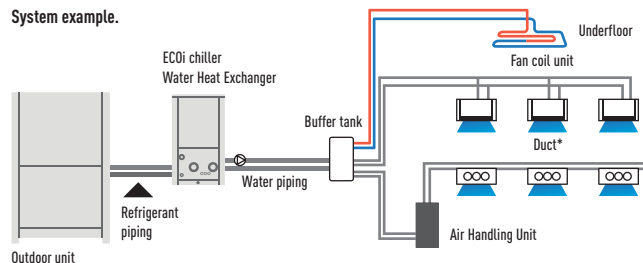

A Buffer tank of minimum 280l for 28 kW and 500l for 50 kW is always needed.

ECOi Water Heat Exchanger

Electrical VRF with Water Heat Exchanger

- With this easy to install Water Heat Exchanger unit, you can now cover projects up to 63 kW hot water demand or 44 kW on chilled application on a efficient way and cost effective.





Aquarea Air Radiators. Fan Coils for Heat Pump application

Fan Coils for Heat Pump application		PAW-AAIR-200-1					PAW-AAIR-700-1					PAW-AAIR-900-1				
Total heating capacity	W	138,00	160,00	217,00	470,00	570,00	223,00	360,00	708,00	1032,00	1188,00	273,00	475,00	886,00	1420,00	1703,00
Water flow	kg/h	23,70	27,50	37,30	80,80	98,00	38,40	61,90	121,80	177,50	204,30	47,00	81,70	152,40	244,20	292,90
Water pressure drop	kPa	0,10	0,20	0,40	2,00	2,90	0,10	0,10	0,30	0,80	1,00	0,10	0,20	0,50	1,60	2,20
	m ³ /min	0,50	0,60	0,90	1,90	2,70	0,70	1,40	2,60	4,20	5,30	0,90	1,80	4,10	6,10	7,70
Air flow	Speed	Main Fan Off	Super Min	Min	Med	Max	Main Fan Off	Super Min	Min	Med	Max	Main Fan Off	Super Min	Min	Med	Max
		3,00	9,00	14,00	18,00	22,00	3,00	9,00	14,00	18,00	22,00	3,00	11,00	16,00	20,00	24,00
Maximum input power	W	2,00	5,00	7,00	9,00	13,00	3,00	9,00	14,00	18,00	22,00	3,00	11,00	16,00	20,00	24,00
Sound pressure	dB(A)	17,60	18,80	24,70	33,20	39,40	18,40	19,60	25,80	34,10	40,20	18,40	22,30	26,20	34,40	42,20
Inlet water temperature	°C	35	35	35	35	35	35	35	35	35	35	35	35	35	35	35
Outlet water temperature	°C	30	30	30	30	30	30	30	30	30	30	30	30	30	30	30
Inlet air temperature	°C	19	19	19	19	19	19	19	19	19	19	19	19	19	19	19
Outlet air temperature	°C	34,50	32,60	38,90	32,00	30,00	34,90	32,40	33,30	31,80	30,60	34,80	32,50	30,20	31,10	30,60
Dimension (H x W x D)	mm	579 x 735 x 129					579 x 935 x 129					579 x 1135 x 129				
Net weight	kg	17					20					23				
3 ways valve included		Yes					Yes					Yes				
Touch screen thermostat		Yes					Yes					Yes				

New line up of Super low temperature radiators for Heat Pump application: Aquarea Air 200/700/900 with radiating effect

The slimline Panasonic Aquarea Air radiators deliver high efficiency climate control.

With a depth of just under 13cm they are at the cutting edge of the market. Blending easily into the home, Aquarea Air's elegant design and product refinements are clear to see in every detail. Exceptional ventilation efficiency means the motor uses considerably less energy (low wattage). The fan speed is continuously modulated by the temperature controller with proportional integral logic, with undoubted advantages for regulating the temperature and humidity in summer mode.



With standard cast radiators.

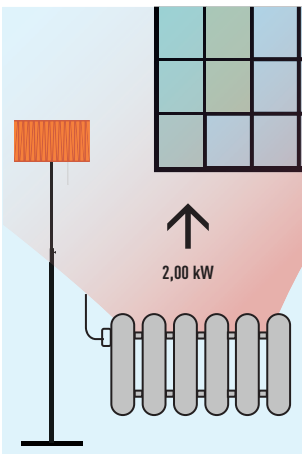

Water at 65 °C needed.

With Aquarea Air.

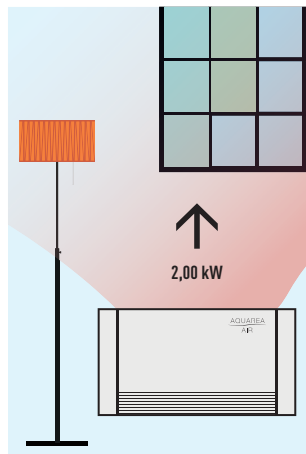

Water at 35 °C needed.

Technical focus:

- Front panel heating with radiant effect
- High heating capacity (without main fan running)
- 4 fan speeds and capacities
- Exclusive design
- Extremely compact (only 12,9cm deep)
- Cooling and dehumidification functions possible (drain is needed)
- 3-way valve included (no overflow valve needed on the installation if more than 3 radiators installed)
- Touch screen thermostat

All temperature curves and capacity are available on www.panasonicproclub.com

NEW DATANAVI



FAST
AND
INTUITIVE

EASY
ACCESS TO
MANUAL
DATABASE

ACCURATE
SERVICE DATA
ON YOUR
SMARTPHONE

Datanavi, a new way to connect.
Simple and easy support tool with your smartphone.



Overview of datanavi system

Just holding up your smartphone to the LED display on a remote controller (CZ-RTC5B) to receive useful AC system information super fast by Panasonic Light ID Technology. Datanavi also connects to Panasonic Cloud Server for the quick view of manuals, saving data received by Light ID.

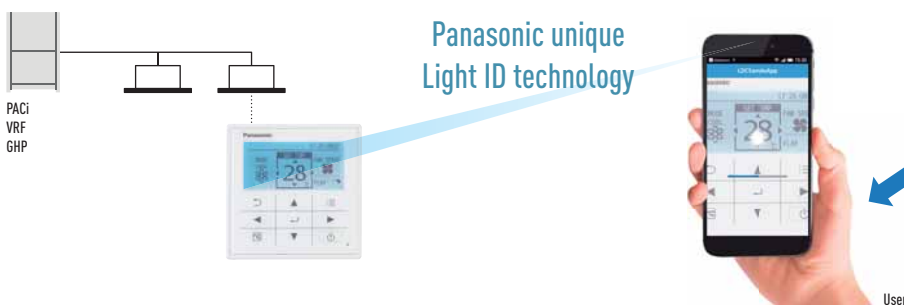

Key Functions

- Scan & Save AC system info
- Easy access to manual database
- Commissioning, F gas check data history

What is the Light ID technology developed by Panasonic?
Visible light transmission technology, which enables to transmit information by high-speed and invisible flashing of an LED light source.

User / Administrator (person in charge of AC) functions

- **Fast and intuitive.** Regular operation data, Energy consumption data display
- **Easy access to data base.** Getting manuals related on demand
- **No idea what to do when an error happens?** You can share error information and contact service easily



Installer / Service company functions

- **Getting technical data depends on your need**
Service manual, Q & A list, Test run information
- **Accurate error information**



Regular operation

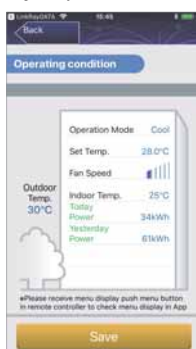

Energy management



Malfunction notice



Operating manual



Test run info



Service data



* User interface image may be updated without notification.

- Simple F-gas regulation check list
- Repair speed check list

















Download free apps, try datanavi!

2 free apps are necessary to use datanavi.



ECOi SYSTEMS INDOOR UNITS RANGE

Page		1,50 kW	2,20 kW	2,80 kW	3,00 kW	3,60 kW	4,00 kW	4,50 kW
P. 160	U2 Type 4 Way 90x90 Cassette							
			S-22MU2E5A	S-28MU2E5A		S-36MU2E5A		S-45MU2E5A
P. 160	Y2 Type 4 Way 60x60 Cassette							
		S-15MY2E5A	S-22MY2E5A	S-28MY2E5A		S-36MY2E5A		S-45MY2E5A
P. 161	L1 Type 2 Way Cassette							
			S-22ML1E5	S-28ML1E5		S-36ML1E5		S-45ML1E5
P. 161	D1 Type 1 Way Cassette							
				S-28MD1E5		S-36MD1E5		S-45MD1E5
P. 162	F2 Type Variable Static Pressure Hide Away							
		S-15MF2E5A	S-22MF2E5A	S-28MF2E5A		S-36MF2E5A		S-45MF2E5A
P. 162	M1 Type Slim Variable Static Pressure Hide Away							
		S-15MM1E5A	S-22MM1E5A	S-28MM1E5A		S-36MM1E5A		S-45MM1E5A
P. 163	E2 Type High Static Pressure Hide Away							
P. 163	Heat Recovery with DX Coil							
					PAW-500ZDX3N	PAW-800ZDX3N	PAW-01KZDX3N	
P. 164	T2 Type Ceiling							
						S-36MT2E5A		S-45MT2E5A
P. 164	K2 Type Wall Mounted							
		S-15MK2E5A	S-22MK2E5A	S-28MK2E5A		S-36MK2E5A		S-45MK2E5A
P. 165	P1 Type Floor Standing							
			S-22MP1E5	S-28MP1E5		S-36MP1E5		S-45MP1E5
P. 165	R1 Type Concealed Floor Standing							
			S-22MR1E5	S-28MR1E5		S-36MR1E5		S-45MR1E5
P. 166	Hydrokit for ECOi, water at 45 °C							

Page		16,00 kW	28,00 kW	56,00 kW	84,00 kW	112,00 kW	140,00 kW	168,00 kW
P. 166	AHU Connection Kit 16, 28 and 56 kW							
		PAW-160MAH2/M/L	PAW-280MAH2/M/L	PAW-560MAH2/M/L	PAW-280MAH2/M/L + PAW-560MAH2/M/L	PAW-560MAH2/M/L x2	PAW-280MAH2/M/L + PAW-560MAH2/M/L x2	PAW-560MAH2/M/L x3

Page		250m³/h	350m³/h	500m³/h	800m³/h	1000m³/h
P. 167	Energy Recovery Ventilation					
		FY-250ZDY8R	FY-350ZDY8R	FY-500ZDY8R	FY-800ZDY8R	FY-01KZDY8R

5,60 kW 6,00 kW 7,30 kW 9,00 kW 10,60 kW 14,00 kW 16,00 kW 22,40 kW 28,00 kW



S-56MU2E5A S-60MU2E5A S-73MU2E5A S-90MU2E5A S-106MU2E5A S-140MU2E5A S-160MU2E5A



S-56MY2E5A



S-56ML1E5



S-73ML1E5



S-56MD1E5



S-73MD1E5



S-56MF2E5A



S-60MF2E5A



S-73MF2E5A



S-90MF2E5A



S-106MF2E5A



S-140MF2E5A



S-160MF2E5A



S-56MM1E5A



S-224ME2E5



S-280ME2E5



S-56MT2E5A



S-73MT2E5A



S-106MT2E5A



S-140MT2E5A



S-56MK2E5A



S-73MK2E5A



S-106MK2E5A



S-56MP1E5



S-71MP1E5



S-56MR1E5



S-71MR1E5



S-80MW1E5



S-125MW1E5

Page

11,40 kW

25,00 kW

31,50 kW

37,50 kW

P. 167

Air Curtain Jet-Flow with DX Coil



PAW-10EAIRC-MJ



PAW-15EAIRC-MJ



PAW-20EAIRC-MJ



PAW-25EAIRC-MJ

P. 167

Air Curtain Standard with DX Coil



PAW-10EAIRC-MS



PAW-20EAIRC-MS

ECOi Systems Indoor units



ECONAVI, nanoe™ X and INTERNET CONTROL: Optional.



U2 Type 4 Way 90x90 Cassette

Tentative data

Model		S-22MU2E5A	S-28MU2E5A	S-36MU2E5A	S-45MU2E5A	S-56MU2E5A	S-60MU2E5A	S-73MU2E5A	S-90MU2E5A	S-106MU2E5A	S-140MU2E5A	S-160MU2E5A		
Cooling capacity	kW	2,20	2,80	3,60	4,50	5,60	6,00	7,30	9,00	10,60	14,00	16,00		
Input power cooling	W	20,00	20,00	20,00	20,00	25,00	35,00	40,00	40,00	95,00	100,00	115,00		
Current (cool)	A	0,19	0,19	0,19	0,19	0,22	0,31	0,33	0,36	0,71	0,76	0,89		
Heating capacity	kW	2,50	3,20	4,20	5,00	6,30	7,10	8,00	10,00	11,40	16,00	18,00		
Input power heating	W	20,00	20,00	20,00	20,00	25,00	35,00	40,00	40,00	85,00	100,00	105,00		
Current (heat)	A	0,17	0,17	0,17	0,17	0,20	0,30	0,32	0,34	0,65	0,73	0,80		
Fan type		Turbo fan	Turbo fan	Turbo fan	Turbo fan	Turbo fan	Turbo fan	Turbo fan	Turbo fan	Turbo fan	Turbo fan	Turbo fan		
Air volume	Hi/ Med/ Lo	m³/min	14,50/ 13,00/ 11,50	14,50/ 13,00/ 11,50	14,50/ 13,00/ 11,50	15,50/ 13,00/ 11,50	17,00/ 13,50/ 11,50	21,00/ 16,00/ 13,00	22,50/ 16,00/ 13,00	23,00/ 18,50/ 14,00	35,00/ 26,00/ 20,00	36,00/ 27,00/ 21,50	37,00/ 29,00/ 25,00	
	Sound pressure	Hi/ Med/ Lo	dB(A)	30/ 29/ 28	30/ 29/ 28	30/ 29/ 28	31/ 29/ 28	33/ 30/ 28	36/ 32/ 29	37/ 32/ 29	38/ 35/ 32	44/ 38/ 34	45/ 39/ 35	46/ 40/ 38
		Sound power	Hi/ Med/ Lo	dB	45/ 44/ 43	45/ 44/ 43	45/ 44/ 43	46/ 44/ 43	48/ 45/ 43	51/ 47/ 44	52/ 47/ 44	53/ 50/ 47	59/ 53/ 49	60/ 54/ 50
Dimension (HxWxD)	Indoor	mm	256 x 840 x 840	256 x 840 x 840	256 x 840 x 840	256 x 840 x 840	256 x 840 x 840	256 x 840 x 840	256 x 840 x 840	256 x 840 x 840	319 x 840 x 840	319 x 840 x 840	319 x 840 x 840	
	Panel	mm	33,5 x 950 x 950	33,5 x 950 x 950	33,5 x 950 x 950	33,5 x 950 x 950	33,5 x 950 x 950	33,5 x 950 x 950	33,5 x 950 x 950	33,5 x 950 x 950	33,5 x 950 x 950	33,5 x 950 x 950	33,5 x 950 x 950	
Net weight (Panel)	kg	21(5)	21(5)	21(5)	21(5)	21(5)	21(5)	21(5)	21(5)	25(5)	25(5)	25(5)		
Piping connections	Liquid	Inch (mm)	1/4(6,35)	1/4(6,35)	1/4(6,35)	1/4(6,35)	1/4(6,35)	3/8(9,52)	3/8(9,52)	3/8(9,52)	3/8(9,52)	3/8(9,52)		
	Gas	Inch (mm)	1/2(12,70)	1/2(12,70)	1/2(12,70)	1/2(12,70)	1/2(12,70)	5/8(15,88)	5/8(15,88)	5/8(15,88)	5/8(15,88)	5/8(15,88)		

* Sound pressure with no refrigerant flow.



ECONAVI and INTERNET CONTROL: Optional.



Y2 Type 4 Way 60x60 Cassette

Model		S-15MY2E5A	S-22MY2E5A	S-28MY2E5A	S-36MY2E5A	S-45MY2E5A	S-56MY2E5A	
Cooling capacity	kW	1,50	2,20	2,80	3,60	4,50	5,60	
Input power cooling	W	35,00	35,00	35,00	40,00	40,00	45,00	
Operating current cooling	A	0,30	0,30	0,30	0,30	0,32	0,35	
Heating capacity	kW	1,70	2,50	3,20	4,20	5,00	6,30	
Input power heating	W	30,00	30,00	30,00	35,00	35,00	40,00	
Operating current heating	A	0,25	0,25	0,30	0,30	0,30	0,30	
Fan type		Centrifugal fan	Centrifugal fan	Centrifugal fan	Centrifugal fan	Centrifugal fan	Centrifugal fan	
Air volume	Cool	m³/min	8,90/8,20/5,60	9,10/8,20/5,60	9,30/8,40/5,60	9,70/8,70/6,00	10,00/9,30/8,20	10,40/9,80/8,50
	Heat	m³/min	9,10/8,40/5,60	9,30/8,40/5,60	9,60/8,70/5,60	9,90/9,10/6,00	10,30/9,60/8,20	11,10/9,80/8,70
Sound pressure	Hi / Med / Lo	dB(A)	34/31/25	35/31/25	35/31/25	36/32/26	38/34/28	40/37/34
Sound power	Hi / Med / Lo	dB	49/46/40	50/46/40	50/46/40	51/47/41	53/49/43	55/52/49
Dimension (HxWxD)	Indoor	mm	288 x 583 x 583	288 x 583 x 583	288 x 583 x 583	288 x 583 x 583	288 x 583 x 583	288 x 583 x 583
	Panel 3A	mm	31 x 700 x 700	31 x 700 x 700	31 x 700 x 700	31 x 700 x 700	31 x 700 x 700	31 x 700 x 700
	Panel 3B	mm	31 x 625 x 625	31 x 625 x 625	31 x 625 x 625	31 x 625 x 625	31 x 625 x 625	31 x 625 x 625
Net weight	kg	20,4(18+2,4)	20,4(18+2,4)	20,4(18+2,4)	20,4(18+2,4)	20,4(18+2,4)	20,4(18+2,4)	
Piping connections	Liquid pipe	Inch (mm)	1/4(6,35)	1/4(6,35)	1/4(6,35)	1/4(6,35)	1/4(6,35)	
	Gas pipe	Inch (mm)	1/2(12,70)	1/2(12,70)	1/2(12,70)	1/2(12,70)	1/2(12,70)	

ECOi Systems Indoor units



ECONAVI and INTERNET CONTROL: Optional.



L1 Type 2 Way Cassette

Model		S-22ML1E5	S-28ML1E5	S-36ML1E5	S-45ML1E5	S-56ML1E5	S-73ML1E5	
Cooling capacity	kW	2,20	2,80	3,60	4,50	5,60	7,30	
Input power cooling	W	90,00	92,00	93,00	97,00	97,00	145,00	
Operating current cooling	A	0,45	0,45	0,45	0,45	0,45	0,65	
Heating capacity	kW	2,50	3,20	4,20	5,00	6,30	8,00	
Input power heating	W	58,00	60,00	61,00	65,00	65,00	109,00	
Operating current heating	A	0,29	0,29	0,29	0,29	0,29	0,48	
Fan type		Sirocco fan	Sirocco fan	Sirocco fan	Sirocco fan	Sirocco fan	Sirocco fan	
Air volume	Hi / Med / Lo	m ³ /min	8,00/7,00/6,00	9,00/8,00/7,00	9,70/8,70/7,70	11,00/9,00/8,00	11,00/9,00/8,00	19,00/16,00/14,00
Sound pressure	Hi / Med / Lo	dB(A)	30/27/24	33/29/26	34/31/28	35/33/29	35/33/29	38/35/33
Dimension	Indoor	mm	350 x 840 x 600	350 x 840 x 600	350 x 840 x 600	350 x 840 x 600	350 x 1140 x 600	
	Panel	mm	8 x 1060 x 680	8 x 1060 x 680	8 x 1060 x 680	8 x 1060 x 680	8 x 1360 x 680	
Net weight (Panel)		kg	23 (5,5)	23 (5,5)	23 (5,5)	23 (5,5)	30 (9)	
Piping connections	Liquid pipe	Inch (mm)	1/4 (6,35)	1/4 (6,35)	1/4 (6,35)	1/4 (6,35)	3/8 (9,52)	
	Gas pipe	Inch (mm)	1/2 (12,70)	1/2 (12,70)	1/2 (12,70)	1/2 (12,70)	5/8 (15,88)	



ECONAVI and INTERNET CONTROL: Optional.



D1 Type 1 Way Cassette

Model		S-28MD1E5	S-36MD1E5	S-45MD1E5	S-56MD1E5	S-73MD1E5	
Cooling capacity	kW	2,80	3,60	4,50	5,60	7,30	
Input power cooling	W	51,00	51,00	51,00	60,00	87,00	
Operating current cooling	A	0,39	0,39	0,39	0,46	0,70	
Heating capacity	kW	3,20	4,20	5,00	6,30	8,00	
Input power heating	W	40,00	40,00	40,00	48,00	76,00	
Operating current heating	A	0,35	0,35	0,35	0,41	0,65	
Fan type		Sirocco fan	Sirocco fan	Sirocco fan	Sirocco fan	Sirocco fan	
Air volume	Hi / Med / Lo	m ³ /min	12,00/10,00/9,00	12,00/10,00/9,00	12,00/11,00/10,00	13,00/11,50/10,00	18,00/15,00/13,00
Sound pressure	Hi / Med / Lo	dB(A)	36/34/33	36/34/33	36/35/34	38/36/34	45/40/36
Dimension	Indoor	mm	200 x 1000 x 710	200 x 1000 x 710	200 x 1000 x 710	200 x 1000 x 710	200 x 1000 x 710
	Panel	mm	20 x 1230 x 800	20 x 1230 x 800	20 x 1230 x 800	20 x 1230 x 800	20 x 1230 x 800
Net weight (Panel)		kg	21 (5,5)	21 (5,5)	21 (5,5)	21 (5,5)	22 (5,5)
Piping connections	Liquid pipe	Inch (mm)	1/4 (6,35)	1/4 (6,35)	1/4 (6,35)	1/4 (6,35)	3/8 (9,52)
	Gas pipe	Inch (mm)	1/2 (12,70)	1/2 (12,70)	1/2 (12,70)	1/2 (12,70)	5/8 (15,88)

ECOi Systems Indoor units



ECONAVI and INTERNET CONTROL: Optional.



F2 Type Variable Static Pressure Hide Away

Model		S-15MF2E5A	S-22MF2E5A	S-28MF2E5A	S-36MF2E5A	S-45MF2E5A	S-56MF2E5A	S-60MF2E5A	S-73MF2E5A	S-90MF2E5A	S-106MF2E5A	S-140MF2E5A	S-160MF2E5A
Cooling capacity	kW	1,50	2,20	2,80	3,60	4,50	5,60	6,00	7,30	9,00	10,60	14,00	16,00
Input power cooling	W	70,00	70,00	70,00	70,00	70,00	100,00	120,00	120,00	135,00	195,00	215,00	225,00
Current (cool)	A	0,57	0,57	0,57	0,57	0,57	0,74	0,89	0,89	0,97	1,30	1,44	1,50
Heating capacity	kW	1,70	2,50	3,20	4,20	5,00	6,30	7,10	8,00	10,00	11,40	16,00	18,00
Input power heating	W	70,00	70,00	70,00	70,00	70,00	100,00	120,00	120,00	135,00	200,00	210,00	225,00
Current (heat)	A	0,57	0,57	0,57	0,57	0,57	0,74	0,89	0,89	0,97	1,34	1,42	1,50
Fan type		Sirocco fan	Sirocco fan	Sirocco fan	Sirocco fan	Sirocco fan	Sirocco fan	Sirocco fan	Sirocco fan	Sirocco fan	Sirocco fan	Sirocco fan	Sirocco fan
Air volume ¹	Hi/ Med/ Lo	14,00/ 13,00/ 9,00	14,00/ 13,00/ 9,00	14,00/ 13,00/ 9,00	14,00/ 13,00/ 9,00	14,00/ 13,00/ 10,00	16,00/ 15,00/ 12,00	21,00/ 19,00/ 15,00	21,00/ 19,00/ 15,00	25,00/ 23,00/ 19,00	32,00/ 26,00/ 21,00	34,00/ 29,00/ 23,00	36,00/ 32,00/ 25,00
	m ³ /min												
	Pa	70 (10-150)	70 (10-150)	70 (10-150)	70 (10-150)	70 (10-150)	70 (10-150)	70 (10-150)	70 (10-150)	70 (10-150)	100 (10-150)	100 (10-150)	100 (10-150)
Sound pressure ²	Hi/ Med/ Lo	33/ 29/ 22	33/ 29/ 22	33/ 29/ 22	33/ 29/ 22	34/ 32/ 25	34/ 32/ 25	35/ 32/ 26	35/ 32/ 26	37/ 34/ 28	38/ 34/ 31	39/ 35/ 32	40/ 36/ 33
	dB(A)												
	dB	55/ 51/ 44	55/ 51/ 44	55/ 51/ 44	55/ 51/ 44	56/ 54/ 47	56/ 54/ 47	57/ 54/ 48	57/ 54/ 48	59/ 56/ 50	60/ 56/ 53	61/ 57/ 54	62/ 58/ 55
Dimension	HxWxD mm	290x800 x700	290x800 x700	290x800 x700	290x800 x700	290x800 x700	290x800 x700	290x1000 x700	290x1000 x700	290x1000 x700	290x1400 x700	290x1400 x700	290x1400 x700
Net weight	kg	29	29	29	29	29	29	34	34	34	46	46	46
Piping connections	Liquid	Inch (mm)	1/4 (6,35)	1/4 (6,35)	1/4 (6,35)	1/4 (6,35)	1/4 (6,35)	3/8 (9,52)	3/8 (9,52)	3/8 (9,52)	3/8 (9,52)	3/8 (9,52)	3/8 (9,52)
	Gas	Inch (mm)	1/2 (12,70)	1/2 (12,70)	1/2 (12,70)	1/2 (12,70)	1/2 (12,70)	5/8 (15,88)	5/8 (15,88)	5/8 (15,88)	5/8 (15,88)	5/8 (15,88)	5/8 (15,88)

1) Value referred to standard settings at shipment (H curve 8, M curve 5, L curve 1). 2) Sound pressure without refrigerant flow.



ECONAVI and INTERNET CONTROL: Optional.



M1 Type Slim Variable Static Pressure Hide Away Concealed Duct

Model		S-15MM1E5A	S-22MM1E5A	S-28MM1E5A	S-36MM1E5A	S-45MM1E5A	S-56MM1E5A
Cooling capacity	kW	1,50	2,20	2,80	3,60	4,50	5,60
Input power cooling	W	36,00	36,00	40,00	42,00	49,00	64,00
Operating current cooling	A	0,26	0,26	0,30	0,31	0,37	0,48
Heating capacity	kW	1,70	2,50	3,20	4,20	5,00	6,30
Input power heating	W	26,00	26,00	30,00	32,00	39,00	54,00
Operating current heating	A	0,23	0,23	0,27	0,28	0,34	0,45
Fan type		Sirocco fan	Sirocco fan	Sirocco fan	Sirocco fan	Sirocco fan	Sirocco fan
Air volume	Hi / Med / Lo	8,00/7,00/6,00	8,00/7,00/6,00	8,50/7,50/6,50	9,00/8,00/7,00	10,50/9,50/8,00	12,50/11,50/10,00
External static pressure	Pa	10 (30)	10 (30)	15 (30)	15 (40)	15 (40)	15 (40)
Sound pressure	Hi / Med / Lo ¹	28/27/25 (30/29/27)	28/27/25 (30/29/27)	30/29/27 (32/31/29)	32/30/28 (34/32/30)	34/32/30 (36/34/32)	35/33/31 (37/35/32)
	dB(A)						
Sound power	Hi / Med / Lo	43/42/40	43/42/40	45/44/42	47/45/43	49/47/45	50/48/46
Dimension	HxWxD mm	200x750x640	200x750x640	200x750x640	200x750x640	200x750x640	200x750x640
Net weight	kg	19	19	19	19	19	19
Piping connections	Liquid pipe	Inch (mm)	1/4 (6,35)	1/4 (6,35)	1/4 (6,35)	1/4 (6,35)	1/4 (6,35)
	Gas pipe	Inch (mm)	1/2 (12,70)	1/2 (12,70)	1/2 (12,70)	1/2 (12,70)	1/2 (12,70)

1) With booster cable using short circuit connection.

ECOi Systems Indoor units



ECONAVI and INTERNET CONTROL: Optional.



E2 Type High Static Pressure Hide Away

Model	100 % Fresh air duct function (by using Kit for 100 % Fresh air)				High pressure duct				
	S-224ME2E5		S-280ME2E5		S-224ME2E5		S-280ME2E5		
	Cooling	Heating	Cooling	Heating	Cooling	Heating	Cooling	Heating	
Capacity	kW	22,40	21,20	28,00	26,50	22,40	25,00	28,00	31,50
Input power	W	290,00	290,00	350,00	350,00	440,00	440,00	715,00	715,00
Operating current	A	1,85	1,85	2,20	2,20	2,45	2,45	3,95	3,95
Air volume	Hi / Med / Lo	m ³ /min 28,30 / - / -		35,00 / - / -		56,00 / 51,00 / 44,00		72,00 / 63,00 / 53,00	
External static pressure	Pa	200		200		140 (60 - 270) ¹		140 (72 - 270) ¹	
Sound pressure ²	Hi / Med / Lo	dB(A) 43 / - / -		44 / - / -		45 / 43 / 41		49 / 47 / 43	
Sound power	Hi / Med / Lo	dB 75 / - / -		76 / - / -		77 / 75 / 73		81 / 79 / 75	
Dimension	H x W x D	mm 479 x 1453 x 1205		479 x 1453 x 1205		479 x 1453 x 1205		479 x 1453 x 1205	
Net weight	kg	102		106		102		106	
Piping connections	Liquid pipe	Inch (mm) 3/8 (9,52)		3/8 (9,52)		3/8 (9,52)		3/8 (9,52)	
	Gas pipe	Inch (mm) 3/4 (19,05)		7/8 (22,22)		3/4 (19,05)		7/8 (22,22)	

KIT for 100 % Fresh air function for 2 Way systems

2x CZ-P160RVK2	Rap valve kit
2x CZ-CAPE2	3 way control PCB
CZ-P680BK2	Distribution Joint kit
	1x Remote controller

KIT for 100 % Fresh air function for 3 Way systems

2x CZ-P160HR3	3 way valve Kit
2x CZ-CAPE2	3 way control PCB
CZ-P680BH2	Distribution Joint kit
	1x Remote controller

Rating Conditions for 100 % Fresh air duct function: Cooling Outdoor 33 °C DB / 28 °C WB. Heating Outdoor 0 °C DB / -2,9 °C WB. 1) Available to select the setting by initial setup. 2) Values with 140Pa setting. * No filter included.



ECONAVI and INTERNET CONTROL: Optional.



Heat Recovery with DX Coil

Model	PAW-500ZDX3N		PAW-800ZDX3N		PAW-01KZDX3N			
	Voltage	V	230	230	230	230		
	Phase	Single Phase	Single Phase	Single Phase	Single Phase	Single Phase		
Power source	Frequency	Hz	50	50	50	50		
Air volume	m ³ /min	8,33	13,33	16,66				
External static pressure ¹	Pa	90	120	115				
Maximum current	Total full load	A	0,6	1,4	2,1			
Input power	W	150	320	390				
Sound pressure ²	dB(A)	39	42	43				
Piping connections	Liquid pipe	Inch (mm)	1/4 (6,35)	1/4 (6,35)	1/4 (6,35)			
	Gas pipe	Inch (mm)	1/2 (12,70)	1/2 (12,70)	1/2 (12,70)			
Heat recovery		Cooling	Heating	Cooling	Heating	Cooling	Heating	
	Temperature efficiency	%	76	76	76	76	76	
Enthalpy efficiency	%	63	67	63	65	60	62	
Saved power summer mode or winter mode*	kW	1,70	4,30 (4,80)	2,50	6,50 (7,30)	3,20	8,20 (9,00)	
DX Coil	Total / Sensible capacity	kW	3,00 / 2,10	2,50 / 2,70	5,10 / 3,50	4,40 / 4,80	5,80 / 4,10	5,20 / 6,70
	Off temperature	°C	15,9	30,1 (29,2)	17,9	27,5 (26,5)	18,6	26,3 (25,3)
	Off relative humidity	%	90	16 (15)	90	14 (13)	89	15 (14)

Nominal summer conditions: Outside air: 32 °C DB, RH 50 %. Ambient air: 26 °C DB, RH 50 %. Nominal winter conditions: Outside air: -5 °C DB, RH 80 %. Ambient air: 20 °C DB, RH 50 %. Cooling mode air inlet condition: 28,5 °C DB, RH 50 %; evaporating temperature 7 °C. Heating mode air inlet condition: 13 °C DB, RH 40 % (11 °C DB, RH 45 %); condensating temperature 40 °C. DB: Dry Bulb; RH: Relative Humidity.

1) Referred to the nominal air flow after filter and plate heat exchanger. 2) Sound pressure level calculated at 1 m far from: ducted supply exhaust air ducted return - first air intake / service side, at normal condition. * Tentative data.

ECOi Systems Indoor units



ECO NAVI and INTERNET CONTROL: Optional.



T2 Type Ceiling

Model		S-36MT2E5A	S-45MT2E5A	S-56MT2E5A	S-73MT2E5A	S-106MT2E5A	S-140MT2E5A
Cooling capacity	kW	3,60	4,50	5,60	7,30	10,60	14,00
Input power cooling	W	35,00	40,00	40,00	55,00	80,00	100,00
Operating current cooling	A	0,36	0,38	0,38	0,44	0,67	0,79
Heating capacity	kW	4,20	5,00	6,30	8,00	11,40	16,00
Input power heating	W	35,00	40,00	40,00	55,00	80,00	100,00
Operating current heating	A	0,36	0,38	0,38	0,44	0,67	0,79
Fan type		Sirocco fan	Sirocco fan	Sirocco fan	Sirocco fan	Sirocco fan	Sirocco fan
Air volume	Hi / Med / Lo	m ³ /min 14,00/12,00/10,50	15,00/12,50/10,50	15,00/12,50/10,50	21,00/18,00/15,50	30,00/25,00/23,00	32,00/28,00/24,00
Sound pressure	Hi / Med / Lo	dB(A) 36/32/30	37/33/30	37/33/30	39/35/33	42/37/36	46/40/37
Sound power	Hi / Med / Lo	dB 54/50/48	55/51/48	55/51/48	57/53/51	60/55/54	62/58/55
Dimension	H x W x D	mm 235 x 960 x 690	235 x 960 x 690	235 x 960 x 690	235 x 1275 x 690	235 x 1590 x 690	235 x 1590 x 690
Net weight	kg	27	27	27	33	40	40
Piping connections	Liquid pipe	Inch (mm) 1/4(6,35)	1/4(6,35)	1/4(6,35)	3/8(9,52)	3/8(9,52)	3/8(9,52)
	Gas pipe	Inch (mm) 1/2(12,70)	1/2(12,70)	1/2(12,70)	5/8(15,88)	5/8(15,88)	5/8(15,88)

* Tentative data.



ECO NAVI and INTERNET CONTROL: Optional.



K2 Type Wall Mounted

Model		S-15MK2E5A	S-22MK2E5A	S-28MK2E5A	S-36MK2E5A	S-45MK2E5A	S-56MK2E5A	S-73MK2E5A	S-106MK2E5A	
Cooling capacity	kW	1,50	2,20	2,80	3,60	4,50	5,60	7,30	10,60	
Input power cooling	W	25,00	25,00	25,00	30,00	30,00	35,00	55,00	80,00	
Operating current cooling	A	0,20	0,21	0,23	0,25	0,32	0,35	0,51	0,70	
Heating capacity	kW	1,70	2,50	3,20	4,20	5,00	6,30	8,00	11,40	
Input power heating	W	25,00	25,00	25,00	30,00	30,00	35,00	55,00	80,00	
Operating current heating	A	0,20	0,21	0,23	0,25	0,32	0,35	0,51	0,70	
Fan type		Cross flow	Cross flow	Cross flow	Cross flow	Cross flow	Cross flow	Cross flow	Cross flow	
Air volume	Cool	m ³ /min 7,90/7,40/6,50	9,00/7,50/6,50	9,50/8,30/6,50	10,90/9,00/6,50	14,50/12,50/10,00	16,00/14,00/12,00	19,50/17,00/14,00	21,50/18,50/15,00	
	Hi / Med / Lo	Heat	m ³ /min 9,00/7,70/6,80	9,20/8,30/6,80	9,70/8,50/6,80	11,20/9,50/6,80	14,50/12,50/10,00	16,00/14,00/12,00	19,50/17,00/14,00	21,50/18,50/15,00
Sound pressure	Hi / Med / Lo	dB(A) 34/32/29	36/33/29	37/34/29	40/36/29	38/35/33	40/37/35	47/44/40	49/46/42	
Sound power	Hi / Med / Lo	dB 49/47/44	51/48/44	52/49/44	55/51/44	53/50/48	55/52/50	62/59/55	64/61/57	
Dimension	H x W x D	mm 290 x 870 x 214	290 x 870 x 214	290 x 870 x 214	290 x 870 x 214	302 x 1120 x 236	302 x 1120 x 236	302 x 1120 x 236	302 x 1120 x 236	
Net weight	kg	9	9	9	9	13	13	14	14	
Piping connections	Liquid pipe	Inch (mm) 1/4(6,35)	1/4(6,35)	1/4(6,35)	1/4(6,35)	1/4(6,35)	1/4(6,35)	3/8(9,52)	3/8(9,52)	
	Gas pipe	Inch (mm) 1/2(12,70)	1/2(12,70)	1/2(12,70)	1/2(12,70)	1/2(12,70)	1/2(12,70)	5/8(15,88)	5/8(15,88)	

ECOi Systems Indoor units



ECONAVI and INTERNET CONTROL: Optional.



P1 Type Floor Standing

Model		S-22MP1E5	S-28MP1E5	S-36MP1E5	S-45MP1E5	S-56MP1E5	S-71MP1E5	
Cooling capacity	kW	2,20	2,80	3,60	4,50	5,60	7,10	
Input power cooling	W	56,00	56,00	85,00	126,00	126,00	160,00	
Operating current cooling	A	0,25	0,25	0,38	0,56	0,56	0,72	
Heating capacity	kW	2,50	3,20	4,20	5,00	6,30	8,00	
Input power heating	W	40,00	40,00	70,00	91,00	91,00	120,00	
Operating current heating	A	0,18	0,18	0,31	0,41	0,41	0,54	
Fan type		Sirocco fan	Sirocco fan	Sirocco fan	Sirocco fan	Sirocco fan	Sirocco fan	
Air volume	Hi / Med / Lo	m ³ /min	7,00/6,00/5,00	7,00/6,00/5,00	9,00/7,00/6,00	12,00/9,00/8,00	15,00/13,00/11,00	17,00/14,00/12,00
Sound pressure	Hi / Med / Lo	dB(A)	33/30/28	33/30/28	39/35/29	38/35/31	39/36/31	41/38/35
Dimension	H x W x D	mm	615 x 1065 x 230	615 x 1065 x 230	615 x 1065 x 230	615 x 1380 x 230	615 x 1380 x 230	615 x 1380 x 230
Net weight		kg	29	29	29	39	39	39
Piping connections	Liquid pipe	Inch (mm)	1/4(6,35)	1/4(6,35)	1/4(6,35)	1/4(6,35)	1/4(6,35)	3/8(9,52)
	Gas pipe	Inch (mm)	1/2(12,70)	1/2(12,70)	1/2(12,70)	1/2(12,70)	1/2(12,70)	5/8(15,88)



ECONAVI and INTERNET CONTROL: Optional.



R1 Type Concealed Floor Standing

Model		S-22MR1E5	S-28MR1E5	S-36MR1E5	S-45MR1E5	S-56MR1E5	S-71MR1E5	
Cooling capacity	kW	2,20	2,80	3,60	4,50	5,60	7,10	
Input power cooling	W	56,00	56,00	85,00	126,00	126,00	160,00	
Operating current cooling	A	0,25	0,25	0,38	0,56	0,56	0,72	
Heating capacity	kW	2,50	3,20	4,20	5,00	6,30	8,00	
Input power heating	W	40,00	40,00	70,00	91,00	91,00	120,00	
Operating current heating	A	0,18	0,18	0,31	0,41	0,41	0,54	
Fan type		Sirocco fan	Sirocco fan	Sirocco fan	Sirocco fan	Sirocco fan	Sirocco fan	
Air volume	Hi / Med / Lo	m ³ /min	7,00/6,00/5,00	7,00/6,00/5,00	9,00/7,00/6,00	12,00/9,00/8,00	15,00/13,00/11,00	17,00/14,00/12,00
Sound pressure	Hi / Med / Lo	dB(A)	33/30/28	33/30/28	39/35/29	38/35/31	39/36/31	41/38/35
Dimension	H x W x D	mm	616 x 904 x 229	616 x 904 x 229	616 x 904 x 229	616 x 1219 x 229	616 x 1219 x 229	616 x 1219 x 229
Net weight		kg	21	21	21	28	28	28
Piping connections	Liquid pipe	Inch (mm)	1/4(6,35)	1/4(6,35)	1/4(6,35)	1/4(6,35)	1/4(6,35)	3/8(9,52)
	Gas pipe	Inch (mm)	1/2(12,70)	1/2(12,70)	1/2(12,70)	1/2(12,70)	1/2(12,70)	5/8(15,88)

ECOi Systems Indoor units



Hydrokit for ECOi, water at 45 °C

Model*		S-80MW1E5		S-125MW1E5	
Power source		230V / Single Phase / 50 Hz		230V / Single Phase / 50 Hz	
Cooling capacity	kW	8,00		12,50	
Heating capacity	kW	9,00		14,00	
Maximum temperature	°C	-45 / -65 ¹		-45 / -65 ¹	
Dimension	H x W x D	892 x 502 x 353		892 x 502 x 353	
Water pipe connector	Inch	R 1 ¼		R 1 ¼	
Water pump (built-in)		DC motor (A class)		DC motor (A class)	
Water flow rate	Cool	L/min	22,90	35,80	
	Heat	L/min	25,80	40,10	
Piping connections	Liquid pipe	Inch (mm)	3/8 (9,52)	3/8 (9,52)	
	Gas pipe	Inch (mm)	5/8 (15,88)	5/8 (15,88)	
	Drain piping		15 ~ 17mm (inner size)	15 ~ 17mm (inner size)	
Operation range	Cool	Ambient	°C	+10 ~ +43	+10 ~ +43
		Water	°C	+5 ~ +20	+5 ~ +20
	Heat	Ambient	°C	-20 ~ +32	-20 ~ +32
		Water	°C	+25 ~ +45	+25 ~ +45
Connectable system		3-Pipe (heat recovery type) VRF System (system capable up to 48 HP)			
Maximum Indoor ratio (connectable hydrokit module capacity ratio)		Total indoor unit + Hydrokit capacity: up to 130 % (** ~ **% vs total outdoor unit capacity)			

1) Max 45 °C by refrigerant circuit (heat pump cycle), over 45 °C is provided by electric heater operation. * Tentative Data.

PANASONIC VENTILATION SOLUTIONS



AHU Connection Kit 16, 28 and 56 kW for ECOi

PAW-160MAH2L	AHU Kit for 16 kW (IP 65)
PAW-280MAH2L	AHU Kit for 28 kW (IP 65)
PAW-560MAH2L	AHU Kit for 56 kW (IP 65)
PAW-160MAH2M	AHU Kit for 16 kW (IP 65, 0-10V demand control*)
PAW-280MAH2M	AHU Kit for 28 kW (IP 65, 0-10V demand control*)
PAW-560MAH2M	AHU Kit for 56 kW (IP 65, 0-10V demand control*)
PAW-160MAH2	AHU Kit for 16 kW (IP 65, 0-10V demand control*, Outdoor temperature shift compensation. Cold draft prevention)
PAW-280MAH2	AHU Kit for 28 kW (IP 65, 0-10V demand control*, Outdoor temperature shift compensation. Cold draft prevention)
PAW-560MAH2	AHU Kit for 56 kW (IP 65, 0-10V demand control*, Outdoor temperature shift compensation. Cold draft prevention)

* With CZ-CAPBC2.

Panasonic Ventilation Solutions



Air Curtain with DX Coil

HP			4 HP	6 HP	8 HP	14 HP	4 HP	8 HP
Air Curtain			PAW-10EAIRC-MJ	PAW-15EAIRC-MJ	PAW-20EAIRC-MJ	PAW-25EAIRC-MJ	PAW-10EAIRC-MS	PAW-20EAIRC-MS
Air flow type			Jet-Flow				Standard	
Air Flow Length [A]	m		1,00	1,50	2,00	2,50	1,00	2,00
Air volume	Hi / Med / Lo	m ³ /min	30,00/25,00/20,00	45,00/38,30/31,70	60,00/50,00/41,70	75,00/63,30/51,70	30,00/25,00/20,00	45,00/38,30/31,70
Cooling capacity nominal ²		kW	9,20	17,50	23,10	24,40	9,20	17,50
Heating capacity nominal		kW	11,40	25,00	31,50	31,50	11,40	31,50
Heating capacity with air in 20 °C, air out 40 / 35 / 30 °C		kW	11,90/8,90/5,90	17,90/13,40/8,90	23,90/17,90/11,90	29,90/22,40/14,90	11,90/8,90/5,900	17,90/13,40/8,90
Max installation height	Good / Normal / Bad	m	3,5/3,1/2,7	3,5/3,1/2,7	3,5/3,1/2,7	3,5/3,1/2,7	3,0/2,7/2,4	3,0/2,7/2,4
Piping connections	Liquid pipe	Inch (mm)	3/8(9,52)	3/8(9,52)	3/8(9,52)	3/8(9,52)	3/8(9,52)	3/8(9,52)
	Gas pipe	Inch (mm)	5/8(15,88)	3/4(19,05)	7/8(22,22)	7/8(22,22)	5/8(15,88)	7/8(22,22)
Noise		dB(A)	40-55	40-56	40-57	40-58	40-55	40-57
Dimension	WxHxD	mm	260 x 1210 x 590	260 x 1710 x 590	260 x 2210 x 590	260 x 2710 x 590	260 x 1210 x 490	260 x 2210 x 490
Net weight		kg	70	100	138	160	60	128
Mini ECOi with air out 40 °C			U-4LE2E5/8 ¹	U-6LE2E5/8 ¹	—	—	U-4LE2E5/8 ¹	U-6LE2E5/8 ¹
Mini ECOi with air out 35 °C			U-4LE2E5/8 ¹	U-4LE2E5/8 ¹	U-6LE2E5/8 ¹	—	U-4LE2E5/8 ¹	U-4LE2E5/8 ¹
Mini ECOi with air out 30 °C			U-4LE2E5/8 ¹	U-4LE2E5/8 ¹	U-4LE2E5/8 ¹	U-5LE2E5/8 ¹	U-4LE2E5/8 ¹	U-4LE2E5/8 ¹
ECOi with air out 40 °C			All models	All models	All models	All models without 8 HP	All models	All models
ECOi with air out 30 °C or 35 °C			All models	All models	All models	All models	All models	All models

All combinations under rated conditions: Heating Outdoor +7 °C DB/+6 °C WB Indoor +20 °C DB. In case of lower outdoor temperatures a higher capacity outdoor unit model may be necessary. 1) Or bigger size. 2) Rated Conditions Cooling Outdoor +35 °C DB Indoor +27 °C DB/+19 °C WB, Discharge temperature ³ 16 °C.

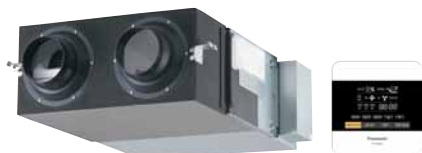

Energy Recovery Ventilation System

Rated flow rate		250m ³ /h			350m ³ /h			500m ³ /h			800m ³ /h			1000m ³ /h		
Models		FY-250ZDY8R			FY-350ZDY8R			FY-500ZDY8R			FY-800ZDY8R			FY-01KZDY8R		
		E-High	High	Low	E-High	High	Low	E-High	High	Low	E-High	High	Low	E-High	High	Low
Power source		220V / 240V / 50Hz			220V / 240V / 50Hz			220V / 240V / 50Hz			220V / 240V / 50Hz			220V / 240V / 50Hz		
Heat exchange ventilation		E-High	High	Low	E-High	High	Low	E-High	High	Low	E-High	High	Low	E-High	High	Low
Input power	W	112,00/128,00	108,00/123,00	87,00/96,00	182,00/190,00	178,00/185,00	175,00/168,00	263,00/289,00	204,00/225,00	165,00/185,00	387,00/418,00	360,00/378,00	293,00/295,00	437,00/464,00	416,00/432,00	301,00/311,00
Air volume	m ³ /h	250	250	190	350	350	240	500	500	440	800	800	630	1000	1000	700
External static pressure	Pa	105	95	45	140	60	45	120	60	35	140	110	55	105	80	75
Sound power	dB	30,00/31,50	29,50/30,50	23,50/26,50	32,50/33,00	30,50/31,00	22,50/25,50	36,50/37,50	34,50/35,50	31,00/32,50	37,00/37,50	36,50/37,00	33,50/34,50	37,50/38,50	37,00/37,50	33,50/34,50
Temperature exchange efficiency	%	75	75	77	75	75	78	75	75	76	75	75	76	75	75	79
Normal ventilation		E-High	High	Low	E-High	High	Low	E-High	High	Low	E-High	High	Low	E-High	High	Low
Input power	W	112,00/128,00	108,00/123,00	87,00/96,00	182,00/190,00	178,00/185,00	175,00/168,00	263,00/289,00	204,00/225,00	165,00/185,00	387,00/418,00	360,00/378,00	293,00/295,00	437,00/464,00	416,00/432,00	301,00/311,00
Air volume	m ³ /h	250	250	190	350	350	240	500	500	440	800	800	630	1000	1000	700
External static pressure	Pa	105	95	45	140	60	45	120	60	35	140	110	55	105	80	75
Sound power	dB	30,00/31,50	29,50/30,50	23,50/26,50	32,50/33,00	30,50/31,00	22,50/25,50	37,50/38,50	37,00/38,00	31,00/32,50	37,00/37,50	36,50/37,00	33,50/34,50	39,50/40,50	39,00/39,50	35,50/36,50
Temperature exchange efficiency	%	—	—	—	—	—	—	—	—	—	—	—	—	—	—	—
Dimension	H x W x D	270 x 882 x 599			317 x 1050 x 804			317 x 1090 x 904			388 x 1322 x 884			388 x 1322 x 1134		
Net weight	kg	29			49			57			71			83		

This noise of the product is the value which was measured at the acoustic room. Actually, in the established condition, that undergo influence by the echoing of the room and so that become bigger than the display numerical value. The input, the current and the exchange efficiency are values at the time of the mentioned air volume. The noise level shall be measured 1,5 m below the centre of the unit. The temperature exchange efficiency averages that of when cooling and when heating.

ACCESSORIES & CONTROL

Distribution Joint Kits

CZ-P680PH2BM

2-Pipe ME2 Series distribution joint kit for outdoor unit (68,00 kW or less).

CZ-P1350PH2BM

2-Pipe ME2 Series distribution joint kit for outdoor unit (more than 68,00 kW).

CZ-P160BK2BM

2-Pipe ME2 Series and Mini ECOi LE Series distribution joint kit for indoor unit (22,40 kW or less*).

CZ-P680BK2BM

2-Pipe ME2 Series distribution joint kit for indoor unit (68,00 kW or less*).

CZ-P1350BK2BM

2-Pipe ME2 Series distribution joint kit for indoor unit (more than 68,00 kW*).

CZ-P680PJ2BM

3-Pipe MF3 Series distribution joint kit for outdoor unit (68,00 kW or less).

CZ-P1350PJ2BM

3-Pipe MF3 Series distribution joint kit for outdoor unit (greater than 68,00 kW and no more than 135,00 kW).

CZ-P224BH2BM

3-Pipe MF3 Series distribution joint kit for indoor unit (22,40 kW or less).

CZ-P680BH2BM

3-Pipe MF3 Series distribution joint kit for indoor unit (greater than 22,40 kW and no more than 68,00 kW).

CZ-P1350BH2BM

3-Pipe MF3 Series distribution joint kit for indoor unit (greater than 68,00 kW and no more than 135,00 kW).

CZ-P4HP3C2BM

3-Pipe MF3 Series header pipe.

* In case the total capacity of indoor units connected after distribution exceeds the total capacity of the outdoor units, select the distribution piping size for the total capacity of the outdoor units.

Heat Recovery Box

KIT-P56HR3

Box recovery kit up to 5,60 kW (CZ-P56HR3 + CZ-CAPE2).



KIT-P160HR3

Box recovery kit from 5,60 kW (CZ-P160HR3 + CZ-CAPE2).

CZ-P56HR3

Heat recovery box up to 5,60 kW.

CZ-CAPE2

Heat recovery PCB.



CZ-P160HR3

Solenoid valve kit up to 10,60 kW.

CZ-P456HR3

4 ports 3 pipe box up to 5,60 kW.



CZ-P4160HR3

4 ports 3 pipe box up to 16,00 kW.

CZ-P656HR3

6 ports 3 pipe box up to 5,60 kW.

CZ-P856HR3

8 ports 3 pipe box up to 5,60 kW.

Individual Controls



CZ-RTC5B

Design wired remote controller with Econavi button and datanavi.



CZ-RTC2

Standard wired remote controller for Floor Standing (MP1).



CZ-RWS3 + CZ-RWRU3

Wireless remote control for 4 Way 90x90 Cassette.



CZ-RWS3

Wireless remote control for Wall Mounted and 4 Way 60x60 (with CZ-KPY3AW).



CZ-RWS3 + CZ-RWRL3

Wireless remote controller for 2 Way Cassette.



CZ-RWS3 + CZ-RWRD3

Wireless remote controller for 1 Way Cassette.



CZ-RWS3 + CZ-RWRT3

Wireless remote control for Ceiling.



CZ-RWS3 + CZ-RWRC3

Wireless remote control for all indoor units.



CZ-CSRC3

Temperature remote sensor.



CZ-RE2C2

Simplified remote control.

Controller for Hotels with Dry Contacts



PAW-RE2C3-WH

Stand-Alone with I/O White frame.

PAW-RE2C3-MOD-WH

Modbus RS-485 with I/O White frame.

PAW-RE2C3-LON-WH

Modbus RS-485 with I/O White frame.

PAW-RE2C3-GR

Stand-Alone with I/O Grey Frame.

PAW-RE2C3-MOD-GR

Modbus RS-485 with I/O Grey frame.

PAW-RE2C3-LON-GR

Modbus RS-485 with I/O Grey frame.

Centralized Controllers



CZ-64ESMC3

System Controller with Schedule timer. Operation with various function from center station.



CZ-ANC3

Central On/Off controller, up to 16 groups, 64 indoor units.



CZ-256ESMC3

Simplified load distribution ratio (LDR) for each tenant. Intelligent Controller (Touch screen panel).

Centralised Controls. BMS System. PC Base



CZ-CSWK2

PAIMS Basic software.



CZ-CSWAC2

PAIMS Consumption calculation control.

CZ-CSWGC2

PAIMS - Layout display.



CZ-CAPDC2

Serial parallel device controlling outdoor units, up to 4 units.



CZ-CAPC3

Adaptor for On/off control of external devices.



CZ-CAPBC2

Mini series parallel device controlling indoor units, maximum 1 group and 8 indoor unit.



CZ-CFUNC2

Communication Adaptor. Up to 128 groups. Controls 128 units.

CZ-CFUNC2

Communication adaptor.

CZ-CSWBC2

PAIMS - BACnet interface.

CZ-CSWWC2

PAIMS - Web application.

Centralised Controls. Connection with 3rd Party Controller

Panasonic AC Smart Cloud



CZ-CFUSCC1
Panasonic AC Smart Cloud. Cloud internet control. Up to 128 groups. Controls 128 units.

PAW-MVNOAC-V
PAW-MVNOAC-K
3G communication package (SIM Card included). V, K. Depending on countries.

VRF Smart Connectivity



SER8150R0B1194
Remote Controller
Panasonic Net Con, RH, No PIR, R1/R2.

SER8150R5B1194
Remote Controller
Panasonic Net Con, RH, PIR, R1/R2.

VCM8000V5094P
Wireless Zigbee Pro module / Green Com card.



SED-WDC-G-5045
Door / window wireless sensor.



SED-MTH-G-5045
Wall / ceiling (motion) wireless sensor.



SED-CO2-G-5045
CO₂ sensor.



Accessories Cables



CZ-T10
Cable for all the T10 functions.



PAW-FDC
Cable to operate external EC fan.



PAW-OCT
Cable for all option monitoring signals.

PAW-EXCT
Cable with force Thermo OFF/leakage Detection.

Accessories PCB



PAW-T10
All T10 functions.



PAW-PACR3
Redundancy of 2 or 3 systems; for PACi and ECOi.

PAW-ECF
PCB for fan speed control of external EC Fan.

Accessories Interfaces



PAW-RC2-KNX-1i
KNX Interface.

PAW-AC-KNX-64
KNX Interface for 64 indoors.

PAW-AC-KNX-128
KNX Interface for 128 indoors.



PAW-AC-BAC-1
BACnet Interface for 1 unit.

PAW-AC-BAC-64
BACnet Interface for 64 indoor units.

PAW-AC-BAC-128
BACnet Interface for 128 indoor units.



PAW-RC2-MBS-1
Modbus Interface.

PAW-AC-MBS-64
Modbus Interface for 64 indoors.

PAW-TM-MBS-RTU-64
Modbus Interface for 64 indoors.



PAW-RC2-MBS-4
Modbus interface to control 4 indoor/groups.

PAW-AC-MBS-128
Modbus Interface for 128 indoors.

PAW-TM-MBS-TCP-128
Modbus Interface for 128 indoors.



PAW-MBS-TCP2RTU
ModBus RTU Slave devices.



CZ-CAPRA1
RAC interface adapter for integration into P Link.



PAW-RC2-ENO-1i
EnOcean Interface.

CZ-CLNC2
Lonworks® Interface controls up to 16 groups and 64 indoor units.



PA-RC2-WIFI-1
Interface for Intesishome for PACi & ECOi.

Pump Down System



PAW-PUDME1A-1
ECOi 2-Pipe Pump down for 1 outdoor unit system.

PAW-PUDME1A-2
ECOi 2-Pipe Pump down for 2 outdoor units system.

PAW-PUDME1A-3
ECOi 2-Pipe Pump down for 3 outdoor units system.

PAW-PUDMF2A-1
ECOi 3-Pipe Pump down for 1 outdoor unit system.

PAW-PUDMF2A-2
ECOi 3-Pipe Pump down for 2 outdoor units system.

PAW-PUDMF2A-3
ECOi 3-Pipe Pump down for 3 outdoor units system.

PAW-PUDME1A-1R
ECOi 2-Pipe Pump down for 1 outdoor unit system + Receiver Kit 30L.

PAW-PUDME1A-2R
ECOi 2-Pipe Pump down for 2 outdoor units system + Receiver Kit 30L.

PAW-PUDME1A-3R
ECOi 2-Pipe Pump down for 3 outdoor units system + Receiver Kit 30L.

PAW-PUDMF2A-1R
ECOi 3-Pipe Pump down for 1 outdoor unit system + Receiver Kit 30L.

PAW-PUDMF2A-2R
ECOi 3-Pipe Pump down for 2 outdoor units system + Receiver Kit 30L.

PAW-PUDMF2A-3R
ECOi 3-Pipe Pump down for 3 outdoor units system + Receiver Kit 30L.

PAW-PUDRK30L
Receiver Kit 30L.

R-22 Replacement Kit

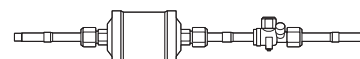

CZ-SLK2
Replacement kit for R-22.

Other Accessory



CZ-CENSC1
Econavi energy savings sensor.

Fan coil Controller



PAW-FC-303TC
Fan coil control.

LEAK DETECTION AND AUTOMATIC REFRIGERANT PUMP DOWN



Improving safety and the environment

Panasonic has developed an innovative solution to detect refrigerant leaks that offer complete assurance and protection for end users, building occupiers and the environment. Panasonic's Pump Down System is ideal for hotels, offices and public buildings where safety for occupants and the building owners is of utmost importance.

The system monitors refrigerant leakage continually and provides a warning before refrigerant leaks, preventing major refrigerant loss and potentially damaging the system's efficiency. The new system can improve potential refrigerant loss to approximately 90 %.

As well as ensuring safe and reliable operation, Panasonic's Pump Down System contributes to a building qualifying for additional BREEAM points and enables compliance with current EN378 2008 standards, covering applications where refrigeration concentration levels exceed practical safety limits of 0,44 kg/m³.

Panasonic has developed two detection methods that can operate simultaneously to offer complete protection for owners, building occupiers and the environment.

Pump Down system

This innovative pump down system can be connected in two ways:

- With sensor leakage
- Without sensor leakage, using only an innovative algorithm

Basic pump down function:

- Detect the leakage
- Activate pump down process
- Collect the gas in the tank
- Close the valves to isolate the gas

Key points:

- Comply with legislation
- Protect personnel
- Protect the environment
- Save on operating costs

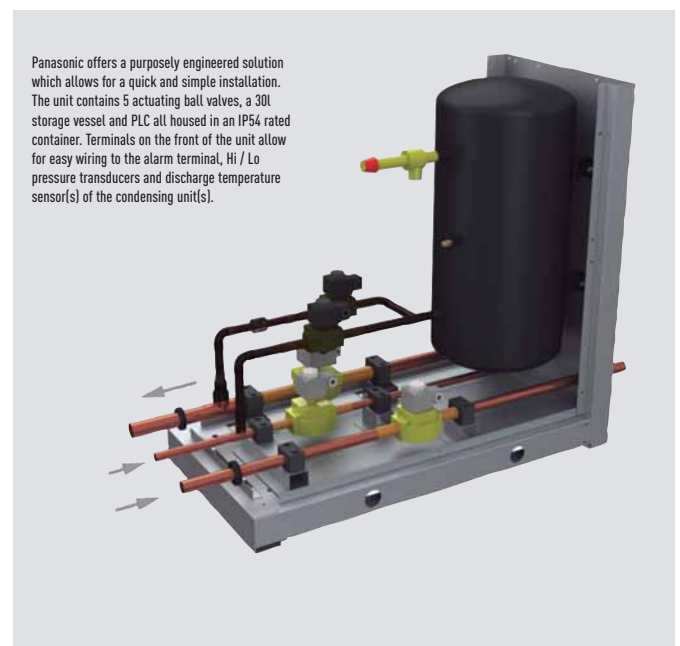

Panasonic offers a purposely engineered solution which allows for a quick and simple installation. The unit contains 5 actuating ball valves, a 30l storage vessel and PLC all housed in an IP54 rated container. Terminals on the front of the unit allow for easy wiring to the alarm terminal, Hi / Lo pressure transducers and discharge temperature sensor(s) of the condensing unit(s).

R22 Renewal

Panasonic's advanced technology enables the system to work with previously installed pipe work by managing the working pressure within the system down to R22 (33 bar) levels, this ensures the system works safely and efficiently without loss of capacity.

The new equipment can offer increased COP/EER by using state of the art inverter compressor and heat exchanger technology.

Having contacted your Panasonic supplier regarding pipe work restrictions

and gained approval to use the Panasonic Renewal System there are three main tests that have to be carried out to ensure that the system can be used effectively. Firstly a thorough inspection of the pipe work must be carried out and any damage must be repaired. Secondly an oil test has to be carried out to ensure that the system has not been subject to a compressor burnout during its lifetime. Lastly a VRF Renewal Kit (CZ-SLK2) has to be installed within the pipe work to ensure that the system is cleaned of any remnants of oil.



DESIGN SUPPORT SOFTWARE FOR VRF

Features the unique Mounting Scheme function providing more thorough spec-in and tender quotation support for easier, faster completion of work

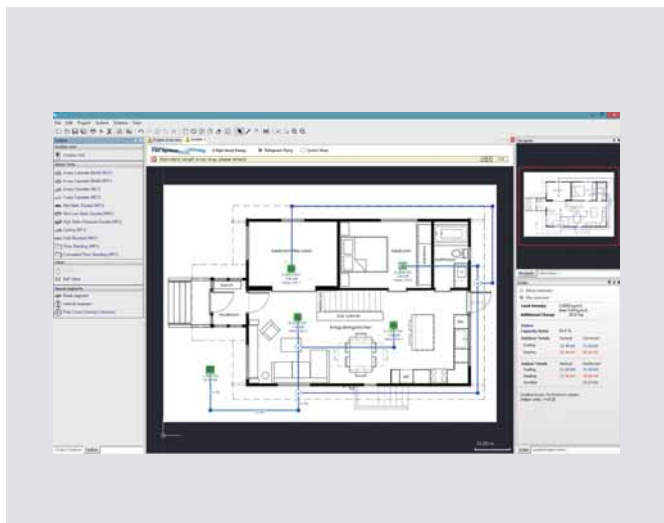

The Panasonic VRF Designer software can be used for all Panasonic VRF ME2, LE and MF3.

Panasonic has identified the importance of ever-increasing demands for fast and accurate responses to customer requests in our industry. More and more emphasis is being placed upon energy-efficiency in our marketplace. The ability to calculate cooling/heating loads and produce information of actual design conditions is a major advantage to any architect, consultant, contractor or end user.

Panasonic understands the time-poor and demanding industry we are in and we are pleased to announce the launch of the next generation of our system design software program.

The Panasonic VRF Designer software has been customised to make the selection and design process as quick and easy as possible.

The design package utilises system wizards and import tools to enable both simple and complex systems to be created. In addition, the system will allow outdoor and indoor units to be dragged on an interactive desktop. This allows users to create everything from realistic floor plans with detailed piping and wiring schematics to send out with quotations, through to installation guidance drawings.

Features include:

- Mounting scheme. Design selection from building floor drawing
- Any kind of drawing format. (dxf, jpg, png..etc.)
- Conventional principal scheme
- Easy to use system wizards
- Auto piping and wiring features
- Converted duties for conditions and pipework
- Auto(CAD) (dxf), Excel and PDF export
- Detailed wiring and pipework diagrams
- Automatic price quotation
- Automatic tender document assist
- SEER, SCOP
- ESEER

Panasonic's Advanced VRF software with AutoCAD® compatibility makes design easier than ever

Panasonic provides bespoke software helping system designers, installers and dealers to very quickly design and size systems, create wiring diagrams and issue bills of quantities at the push of a button.

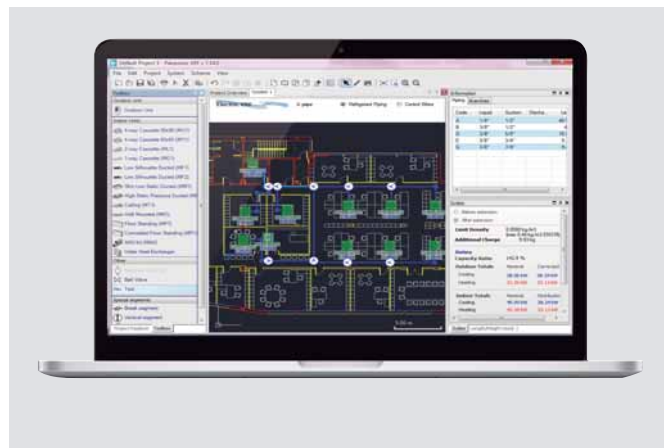

Panasonic VRF Service Checker

Panasonic will make available to installers and commissioning companies the VRF Service Checker as a communication interface to Panasonic VRF systems. This easy to manage tool checks all parameters of the system.

The VRF Service Checker allows:

- On ECOi and Mini ECOi connect anywhere on the P-Link
- Search the P-Link to validate systems that are connected
- Monitor all indoor and outdoor units simultaneously on 1 screen
- Monitor all Temperature data, Pressure data, Valve position, and alarm status on 1 screen
- Data can be viewed in Graph or number format
- Controlling the indoor unit ON/OFF, MODE, SET POINT, FAN, and TEST mode
- Switching between various systems on same communication P-Link (ECOi only)
- Monitor and record at a set interval time
- Record and review the data at a later date
- Update software as ROM flash writer

This Panasonic VRF Service Checker is available from your service partner.

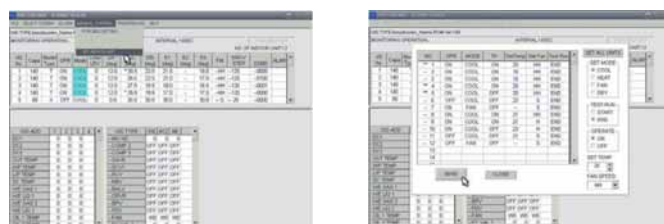

Interface Box

CONTROL AND CONNECTIVITY

Centralized Control Systems

BMS System. PC Base



P-AIMS. Basic Software
Up to 1024 groups. Controls 1024 units.
CZ-CSWK2C

Connection with 3rd Party Controller



Seri-Para I/O unit for outdoor unit.
Up to 4 outdoor units.
CZ-CAPDC2



Local adaptor for ON/OFF control.
Controls 1 to 8 units.
CZ-CAPC3



Mini Seri-Para I/O Unit 0 - 10V.
Controls 1 to 8 units.
CZ-CAPBC2



Communication Adaptor.
Up to 128 groups. Controls 128 units.
CZ-CFUNC2

AC Smart Cloud



Cloud internet control.
Up to 128 groups. Controls 128 units.
CZ-CFUSCC1

New Domestic integration to P Link - CZ-CAPRA1

Can connect all ranges to P Link. Full control is now possible.

Integrates any unit in big system control

- PKEA Server room integration
- Small offices with Domestic indoors
- Tender for refurbishment (old system Domestic and VRF in one installation)

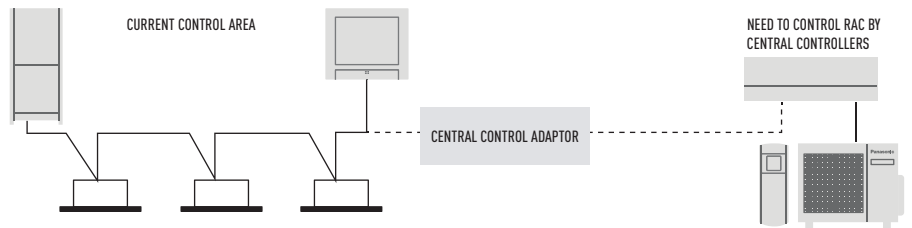

Current system for PACI / VRF. Central controller can connect to S-link line to control units directly.



RAC units cannot connect directly to S-link to be managed by Central Controllers.



It's necessary to have interface between S-link and RAC protocol to cover basic operating items.

Centralized Control Systems: 64 Indoor Units

Intelligent Controller / Web Server: 256 Indoor Units

P-AIMS: 1024 Indoor Units

Basic operation items

ON/OFF	✓
Mode select	✓
Temperature setting	✓
Fan speed	✓
Flap setting	✓
Remote control prohibit	✓
Econavi ON/OFF	✓

External input

ON/OFF control signal	✓
Abnormal stop signal	✓
External output for Relay¹⁾	
Operation status (ON/OFF)	✓
Alarm status output	✓







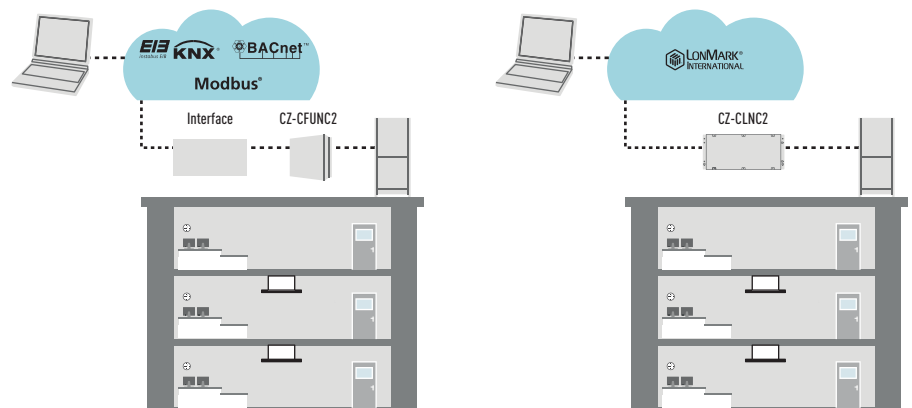

1) Because current CN-CNT connector can not provide the power for external output relay, additional Input power for external relay is necessary.

Easy connection to KNX, Modbus, LonWorks and BACnet

Great flexibility for integration into your KNX / Modbus / LonWorks / BACnet projects allows fully bi-directional monitoring and control of all the functioning parameters.

For more information, contact Panasonic.



			Econavi control	Built-in thermostat	Indoor units which can be controlled	Use limitations	Function ON/OFF	Mode setting	Fan speed setting	Temperature setting	Air flow direction	Permit/Prohibit switching	Weekly program	BMS protocol
Individual Controllers														
Control for hotel application. Intelligent Controller		PAW-RE2C3-WH /-GR PAW-RE2C3-MOD-WH /-GR PAW-RE2C3-LON-WH /-GR White / Grey	-	✓	1 indoor unit	-	✓	✓	✓	✓	-	✓	-	Stand alone Modbus or LonWorks
Wired remote controller. Design wired remote controller with datanavi		CZ-RTC5B	✓	✓	1 group, 8 units	• Up to 2 controllers can be connected per group	✓	✓	✓	✓	✓	-	✓	-
Wired remote controller. Normal operation		CZ-RTC2 (for Floor Standing (MP1) indoor units)	-	✓	1 group, 8 units	• Up to 2 controllers can be connected per group	✓	✓	✓	✓	✓	-	✓	-
Wireless remote controller		CZ-RWS3 + CZ-RWRU3 / CZ-RWS3 / CZ-RWS3 + CZ-RWRL3 / CZ-RWS3 + CZ-RWRD3 / CZ-RWS3 + CZ-RWRT3 / CZ-RWS3 + CZ-RWRC3	-	✓	1 group, 8 units	• Up to 2 controllers can be connected per group	✓	✓	✓	✓	✓ ¹	-	-	-
Quick and easy operation Simplified remote controller		CZ-RE2C2	-	✓	1 group, 8 units	• CZ-RE2C2: up to 2 controllers can be connected per group	✓	✓	✓	✓	✓ ¹	-	-	-
Centralized Controllers														
Central controller with weekly timer		CZ-64ESMC3	✓	-	64 groups, maximum 64 units	• Up to 10 controllers, can be connected to one system • Main unit/sub unit (1 main unit + 1 sub unit) connection is possible • Use without remote controller is possible	✓	✓	✓	✓	✓ ¹	✓	✓	-
Only ON/OFF operation from center station. ON/OFF Controller		CZ-ANC3	-	-	16 groups, maximum 64 units	• Up to 8 controllers (4 main units + 4 sub units) can be connected to one system • Use without remote controller is impossible	✓	-	-	-	-	✓	-	-
Simplified load distribution ratio (LDR) for each tenant. Intelligent Controller (Touch screen panel)		CZ-256ESMC3	✓	-	Main unit: 128. Up to 256 units can be expanded	• Communication adaptor CZ-CFUNC2 is necessary for connection with more than 128 units	✓	✓	✓	✓	✓ ¹	✓	✓	-

1. Setting is not possible when a remote controller unit is present (use the remote controller for setting). * All specifications subject to change without notice.

VRF SMART CONNECTIVITY

Connect to the future. VRF Smart Connectivity

Through thorough energy management, Panasonic's VRF Smart Connectivity is a completely new, state-of-the-art solution providing energy saving and comfort as well as simple installation, operation and running.

Panasonic, passionately pursuing the ultimate in energy saving through the application of cutting-edge technology, and Schneider Electric, an advanced global energy management specialist offering innovative control systems. This collaboration has set the new standard for creating the next generation of contemporary buildings.

VRF Smart Connectivity Advantages

-  Easy Design and Plug and Play to Reduce CapEx
-  Dramatic Reduction of OpEx with Outstanding IAQ
-  Ultimate Customization
-  User-/Owner-friendly

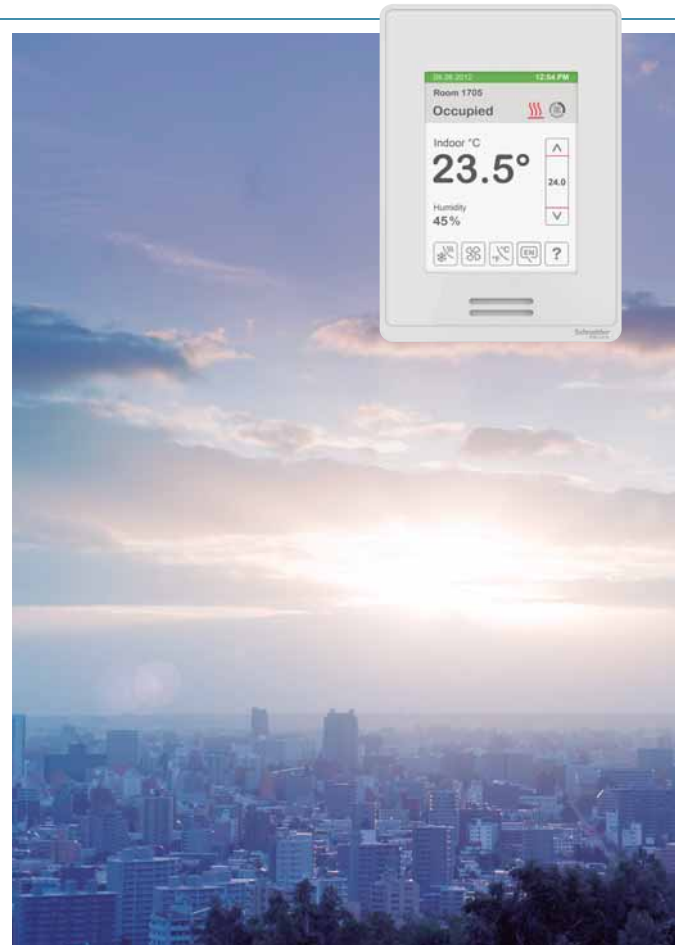

VRF Smart Connectivity. The future of Control

A remote controller is all that's required for occupancy control and optimum automatic indoor air quality (IAQ) control. Simple operation with a rented interface further contributes to increased energy efficiency and productivity for reduced capital expenditure (CapEx) and operating expense (OpEx).

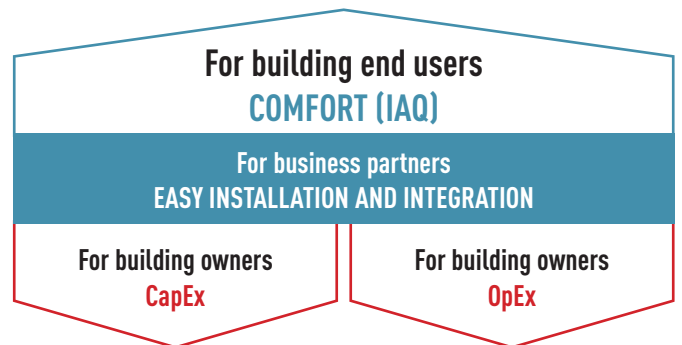

VRF Smart Connectivity Devices

2 types of devices depending on type connection with indoor units wireless or wired. Wireless connection to indoor unit requires ZigBee interface for indoor unit.

Features

- Up to 5-year battery life, batteries included
- Battery level is a point
- New ZigBee® protocol 3.0 Green Power is available in sensors
- Sensor points visible in SBO when SE8000 is integrated via BACnet MS/TP
- Sensor status and battery level visible in SBE when SE8000 is integrated via ZigBee® Pro
- Integration to SBE only recommended when each MPM is connected to Ethernet and are set as ZigBee® Coordinator nodes

CO₂ and humidity sensors for high IAQ

CO₂ sensors taking measurements in units of ppm, and humidity sensors enable fine air quality control. This creates the most comfortable space for occupants while contributing to improved employee satisfaction.



Stand alone Smart Connection

VRF Smart connectivity connects Panasonic ECOi and PACi indoor units by wired connection.

Wired Solution

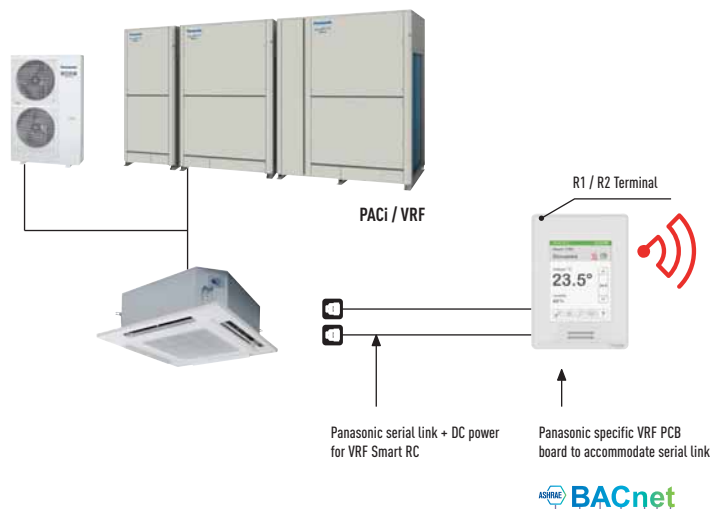

ZigBee® Sensors

- Door / window wireless sensor
- Wall / ceiling (motion) wireless sensor
- CO₂ sensor

VRF Smart application and HMI. Powered over communication serial link. BACnet, Modbus, ZigBee. One RC to one VRF FCU.

Sensing Technology

The wireless solution using sensors born from the collaboration between Panasonic and Schneider Electric enables easy installation in existing and old buildings in which wiring is difficult (installation in a wired environment is also possible). The result is high-quality occupancy control and automatic IAQ control.

The sensors detect the presence or absence of occupants, and the opening and closing of doors and windows to achieve efficient energy management for exceptional air-conditioned comfort. Flexible installation is possible to match different applications and building features such as walls, ceilings and closeness to doors and windows. No wiring means extra installation versatility.

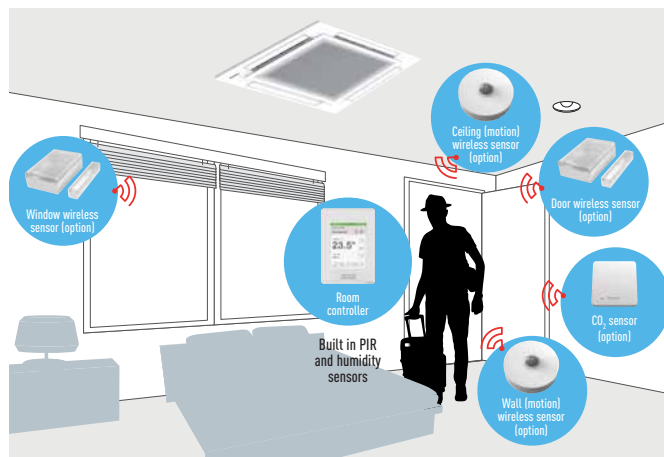

Batteries last for up to five years and are easy to install and replace.



PANASONIC CONDENSING UNITS WITH NATURAL REFRIGERANT



Panasonic is now introducing the new environmentally friendly CO₂ condensing units for commercial refrigeration.

With Panasonic condensing units you can expect:

- Energy savings
- Low noise levels
- Light weight
- Low refrigerant charge
- Low installation cost
- Low costs on servicing

Choose the green solution by Panasonic.

Reliability is our main target and therefore we offer compressor warranties of 5 years, and 2 year warranties on other components!



Showcases.

Convenience stores, supermarket, gas stations.

CO ₂ Model	Showcase type example
4,00 kW / OCU-CR200VF5	Reach in Freezer
15,00 kW / OCU-CR1000VF8	Open Showcase (Total width 850cm) / Dessert Showcase / Walk-in Refrigerator (6 or 7 doors)

* Showcases are local supply.

Cold room application to keep food fresh.

Hotel, school, hospital.

CO ₂ Model		4,00 kW / OCU-CR200VF5		15,00 kW / OCU-CR1000VF8	
Cold room	Eva. temperature	-30 °C	-10 °C	-30 °C	-10 °C
	Room size example*	10 m ³	40 m ³	NA	200 m ³

* Room size is reference. Please contact to authorized Panasonic dealer for calculation.



3,83

SEPR COOLING*

1,92

SEPR FREEZING*

Condensing units VF Series.

4,00 kW Units: high pressure type, both MT or LT, 4,00 kW / 2 HP.

15,00 kW Units: transfer pressure control type, multiple evaporator and 15,00 kW / 10 HP.

* SEPR values has been tested at 3-part laboratory.

Reliable CO₂ technology by Panasonic.

Reliable Quality: Made in Japan. Experience: 8.500 units sold and installed in 3.100 retail operations such a convenience stores and supermarkets in Japan*. Excellent quality control established by skilled factory team. Panasonic offers 5 year warranties on compressor and 2 years on components. The 5 year compressor warranty matches the products long lifetime.

* As of the end of March 18.



The environmentally friendly and reliable solution for convenience stores, supermarket, gas stations and cold rooms.

Why CO₂? : Natural refrigerant

Carbon dioxide (R-744) is regaining its place in the refrigeration world. Driven by environmental concerns, legislation is requiring increased adoption of 'alternative' refrigerants, of which CO₂ is one.

CO₂ is a very attractive refrigerant from an environmental perspective. Zero ODP and "GWP" (Global Warming Potential)=1 means natural substance in the atmosphere.

In Europe a step-by-step HFC reduction has been in place since the F Gas regulation was introduced in 2015.

In fact, not only in Europe but also other countries all over the world have actively been preparing to enact the necessary domestic legislation to implement the agreement for reducing the use of HFCs.

Panasonic is now able to provide a solution in Europe with CO₂ refrigeration systems to prevent global warming and to support environment-friendly retail operations.

The following table shows how well R744 (CO₂) performs regarding environmental impact and safety.

ODP (Ozone Depletion Potential) = 0 - GWP (Global Warming Potential) = 1.

	Next generation refrigerant			Current refrigerant	
	CO ₂	Ammonia	Isobutane	R410A	R404A
ODP	0	0	0	0	0
GWP	1	0	4	2090	3920
Flammability	Non flammable	Light flammable	Flammable	Non flammable	Non flammable
Toxicity	No	Yes	No	No	No

Comparison of CO₂ emissions

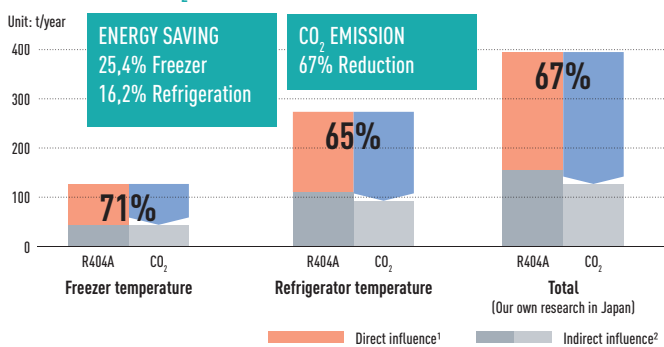

1) Direct influence presents the effect of refrigerant leakage comparing R744 (CO₂) with R404A.
 2) Indirect influence presents CO₂ emissions linked to power consumption of CO₂ unit and conventional units.
 By Panasonic research in Japan. Comparing 6 shops average for R404A inverter multi condensing unit.

Saving installation time with Plug & Play kit

To ensure a quick and easy install of the product, Panasonic has designed a one box solution that includes the condensing unit, a panel pre-programmed controller, expansion valve and sensors in addition to providing easy to understand instructions.

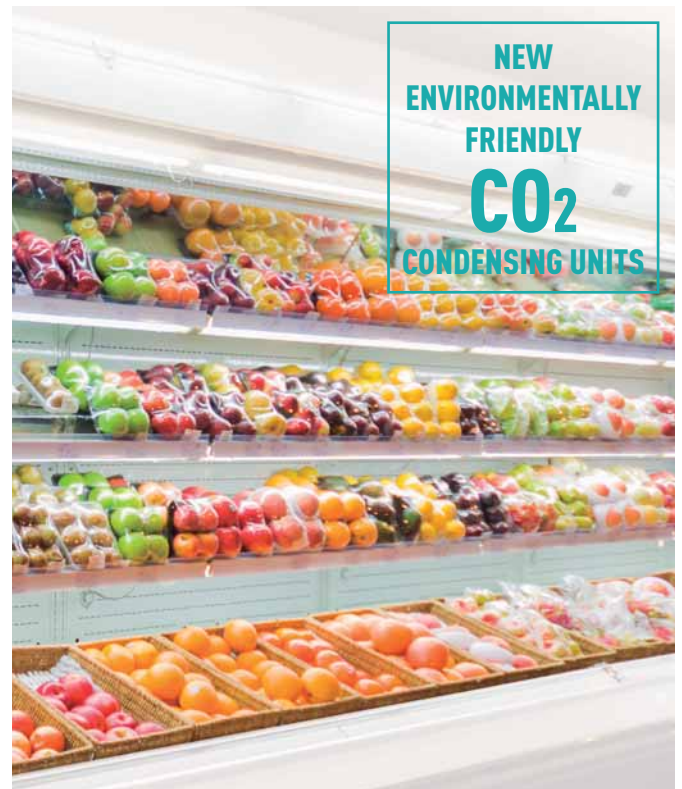

CO₂ transcritical condensing units VF Series

- Set-points at medium or low temperature available depending on applications (200VF5: ET -45 ~ -5 °C, 1000VF8: ET -20 ~ -5 °C)
- High COP at high ambient temperature thanks to Panasonic's 2-stage compression CO₂ rotary compressor
- Compact and extremely quiet. Noise level is minimal, only 35,5 dB(A) (200VF5 model)
- Transfer Pressure control for stable expansion valve control in showcases (1000VF8 model only)

Cold chain applications

Panasonic's VF Series of CO₂ condensing units provide the ideal solution for supermarkets, convenience stores and gas stations.

Keeping food always fresh at right temperature in showcases or cold rooms is a very critical point. And one of the biggest challenges for those retailers has been the expensive effects of refrigeration breakdowns which can result in costly product wastage.

Panasonic's reliable CO₂ solution helps address the above issue by having a stable and reliable all year-round system to help maximise energy efficiency.

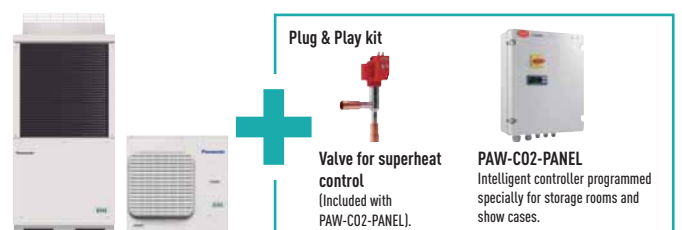



Condensing units with natural refrigerant

Model			OCU-CR200VF5	OCU-CR200VF5SL	OCU-CR1000VF8	OCU-CR1000VF8SL		
Description			4 kW unit standard version	4 kW CO ₂ + anti corrosion coating	15 kW unit standard version	15 kW CO ₂ + anti corrosion coating		
Cooling capacity at -35 °C	Nominal	kW	1,80	1,80	N/A	N/A		
Cooling capacity at -10 °C	Nominal	kW	3,70	3,70	14,0	14,0		
Evaporation temperature	Min - Max	°C	-45 ~ -5	-45 ~ -5	-20 ~ -5	-20 ~ -5		
Power supply	Voltage	V	220/230/240	220/230/240	380/400/415	380/400/415		
	Phase		Single Phase	Single Phase	Three Phase	Three Phase		
	Frequency	Hz	50	50	50	50		
Refrigerant			R744	R744	R744	R744		
Design pressure liquid line		Mpa	12	12	8/12	8/12		
Design pressure suction line		Mpa	8	8	8	8		
Compressor type			2- stage rotary	2- stage rotary	2- stage rotary	2- stage rotary		
Dimensions	H x W x D	mm	930 x 900 x 437	930 x 900 x 437	1941 x 890 x 890	1941 x 890 x 890		
Weight		Kg	70	70	293	293		
Ambient temperature	Min - Max	°C	-15 ~ +43	-15 ~ +43	-15 ~ +43	-15 ~ +43		
Connection piping	Suction pipe	Inch (mm)	3/8 (9,52)	3/8 (9,52)	3/4 (19,05)	3/4 (19,05)		
	Liquid pipe	Inch (mm)	1/4 (6,35)	1/4 (6,35)	5/8 (15,88)	5/8 (15,88)		
Length of connection piping		m	25	25	100	100		
	Ambient temperature	°C	32	32	32	32		
Standard performance	Evaporating temperature	°C	-10	-35	-10	-35	-10	-35
	Cooling capacity	kW	3,70	1,80	3,70	1,80	14,00	14,00
	Power consumption	kW	1,79	1,65	1,79	1,65	8,20	8,20
	Nominal load ampere	A	7,94	7,26	7,94	7,26	12,60	12,60
	Sound pressure level	dB(A)	35,5 ¹	35,5 ¹	35,5 ¹	35,5 ¹	36,0 ²	36,0 ²

Accessories

PAW-CO2-PANEL	Room and superheat control including both Panel + expansion valve
PAW-CO2-FILTER-1	Filter, liquid line

Accessories

SPK-TU125	Filling pipe
S-008T³⁾	Suction Filter
PAW-CO2-WPH-2HP	Snow protection



1) ET -10 °C, 65 S-1, 10 m from product. - 2) ET -10 °C, 60 S-1, 10 m from product. 3) For 15,00 kW model.

Superior cooling capacity at each evaporating temperature

CO₂ Transcritical Condensing units have a high cooling capacity at each set point.

CO₂ 2-stage compression rotary compressor developed by Panasonic is designed to compress CO₂ refrigerant twice; it reduces load in operation by half compared with 1-stage refrigerant compression and delivers better durability and reliability.

Units can be set to run at low and medium temperatures with four initial settings. These settings can then be modified by turning a simple and user friendly rotary switch to further enhance energy savings. (200VF5 model only).

4,00 kW: OCU-CR200VF5(SL).

This compact unit provides flexibility to adapt to changing needs of refrigeration depending on the install setting.

4,00 kW: OCU-CR200VF5(SL)

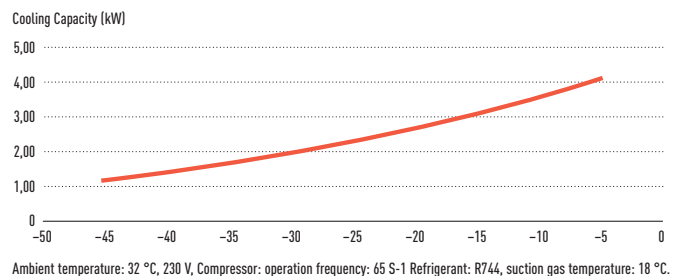

15,00 kW: OCU-CR1000VF8(SL)

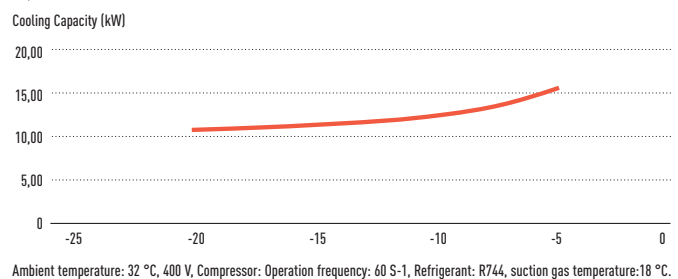

Energy saving



Better efficiency & Value for medium temperature applications. Energy efficiency class up to A++ in a scale from A++ to G.



Better efficiency & Value for low temperature applications. Energy efficiency class up to A++ in a scale from A++ to G.



Better efficiency & Value for Domestic Hot Water. Energy efficiency class up to A in a scale from A to G.



Aquarea are built-in with A class energy efficiency water pump. High efficiency circulating the water in the heating installation.



Refrigerant R32. Our heat pumps containing the new refrigerant R32 show a drastic reduction in the value of Global Warming Potential (GWP). An important step to reduce greenhouse gases. R32 is also a components refrigerant, making it easy to recycle.



RAC Econavi. The sensor determines the human activity level and the position in the room and adjust the air flow orientation for maximum comfort and maximum savings, and detects changes in sunlight intensity and judges whether it is sunny or cloudy/night. It reduces unnecessary heating under more sunlight conditions.



PACi and VRF Econavi. Intelligent Human Activity Sensor and new Sunlight Sensor technologies that can detect and reduces the waste of energy by optimising air conditioner operation according to room conditions. With just one touch of a button, you can save energy.



Exceptional Seasonal Cooling Efficiency based on the new ErP regulation. Higher SEER ratings mean greater efficiency. Save all the year while cooling!



Exceptional Seasonal Heating Efficiency based on the new ErP regulation. Higher SCOP ratings mean greater efficiency. Save all the year while heating!



Inverter Plus System classification highlights the highest performing Panasonic systems.



The Inverter range provides greater efficiency and comfort. Provides more precise temperature control, without highs and lows, and keeps the ambient temperature constant with lower energy consumption and a significant reduction in noise and vibration levels.



R2 Rotary Compressor. Panasonic R2 Rotary Compressor. Designed to withstand extreme conditions, it delivers high performance and efficiency.



Compressor High Efficient. Compressors that operate with a wider Hz range realize a more efficient operation throughout the year. For Big PACi Series PE2.



Multiple large-capacity all Inverter compressors (more than 14 HP). Two independently controlled Inverter compressors achieve high efficiency. Redesigned components in the body provide performance improvement especially in the rated cooling condition and EER performance.



High efficiency models performs higher COP than standard units and standard combinations.

High performance and healthy air



Aquarea High Performance for low consumption houses. From 3 to 16 kW. For a house with low temperature radiators or under-floor heating, our high performance Aquarea HP is a good solution. *COP of 5,08 for 5 kW Mono-bloc.



Aquarea T-CAP for extremely low temperatures. From 9 to 16 kW. If the most important aspect is to maintain nominal heating capacities even at temperatures as low as -7 °C or -15 °C, select the Aquarea T-CAP.



Aquarea HT ideal for retrofit. From 9 to 12 kW. For a house with traditional high-temperature radiators, the Aquarea HT solution is the most appropriate, can work in output water temperatures of 65 °C even at outdoor temperatures as low as -20 °C.



DHW. With Aquarea you can also heat your domestic hot water at a very low cost with the optional hot water cylinder.



Water filter (easy access & fast clip technology) for H Generation.



Water stop valve included on H Generation.



Water Flow Sensor included on H Generation.



nanoe™. nanoe™ utilises nano-technology fine particles to purify the air in the room. It works effectively on airborne and adhesive micro-organisms such as certain types of bacteria, viruses and mould thus ensuring a cleaner living environment.



The new dust collector filter included on Panasonic units is able to collect dust in order to enjoy a clean and healthy air. Available on: LZ25/35, NZ25/35/50 and CZ25/35.



PM2,5 Filter. Particulate matter (PM2,5) can be found suspended in the air, including dust, dirt, smoke and liquid droplets. This filter can catch PM2,5 particles including hazardous pollutants as well as house dust and pollen.



Super Quiet. Thanks to its latest generation compressor and its twin blade fan, our outdoor unit is one of the most silent on the market. The indoor unit emits an almost imperceptible 18 dB(A).



Mild Dry Cooling. Fine control helps prevent a rapid decrease in room humidity while maintaining the set temperature. Maintains an RH* up to 10 % higher than cooling operation (*RH: Relative Humidity). Ideal when sleeping with the air conditioner on.



Aerowings. More comfort with Aerowings. Direct airflow to ceiling to create shower cooling effect by twin flap built in indoor.



Down to -35 °C in heating mode. The air conditioner works in heat pump mode with an outdoor temperature is as low as -35 °C. Tested by SP.



Down to -10 °C in cooling only mode. The air conditioner works in cooling only mode with an outdoor temperature of -10 °C.



The ECOi EX system works in cooling mode with performance data at outdoor temperature up to 52 °C.



Summer House, this innovative function keeps the house at 8/10 or 8/15 °C to avoid freezing pipes during the winter. This function is highly appreciated in summer house or week end houses.



Designed for simple replacement of older Panasonic models.



Low Static Pressure Hide Away RAC with selectable static pressure up to 7 mmAq.



Panasonic has extended the life of its condensers with an original anti-rust coating. For Big PACi Series PE2 and ECOi EX.



Big size Fan makes larger airflow rate and very silent operation at low speed. For Big PACi Series PE2.



DC Fan: Safe and precise.



Self-diagnosing function. By using electronic control valves past warnings are stored. This makes it easier to diagnose malfunctions, reducing service labour and therefore costs.



Automatic fan operation. Convenient microprocessor control automatically adjusts fan speed to High, Medium or Low, corresponding to room sensor and maintains comfortable airflow throughout the room.



Comfortable auto-flap control. When the unit is first turned on, flap position is automatically adjusted in accordance with the cooling or heating operation.



Automatic restart function for power failure. Even when power failure occurs, preset programmed operation can be reactivated once power is resumed.



Air Sweep. The air sweep function moves the flap up and down in the air outlet, directing air in a "sweeping" motion around the room and providing comfort in every corner.



By intermittent control of compressor and indoor unit's fan, "Mild Dry" gives you comfort. It realizes efficient dehumidification according to room temperature.



Built-in drain pump. Maximum head 50cm (or 75cm for U type) from the bottom of the unit.



R22 Renewal. The Panasonic renewal system allows good quality existing R22 pipe work to be re-used whilst installing new high efficiency R410A systems.



R410A/R22 Renewal. The Panasonic renewal system allows good quality existing R410A or R22 pipe work to be re-used whilst installing new high efficiency R32 systems.

High connectivity



Renovation. Our Aquarea Heat Pumps can be connected to an existing or new boiler for optimum comfort even at very low outdoor temperatures.



Solar Kit. For even greater efficiency, our Aquarea Heat Pumps can be connected to photovoltaic solar panels with an optional kit.



New remote controller with full dotted 3,5" wide back light screen. Menu with 17 available languages easy to use for installer and user. Included on H Generation.



CZ-CAPRA1: CZ-CNT port integration to PACi and ECOi. Split Air Conditioners integration to P Link. Can connect ranges to P Link. Full control is now possible.



Internet Control. Internet Control is a next generation system providing user-friendly remote controller of air conditioning or heat pump units from everywhere, using a simple Android or iOS smartphone, tablet or PC via internet.



Easy control by BMS. The communication port is integrated into the indoor unit and provides easy connection to, and control of, your Panasonic heat pump to your home or building management system.



AC Smart Cloud. The AC Smart Cloud from Panasonic allows you to have complete control of all your installations. In a simple click, receive status updates from all your units in real-time, preventing breakdowns and optimizing costs.



5 Years Warranty. Panasonic guarantees the compressors in the entire range for five years.



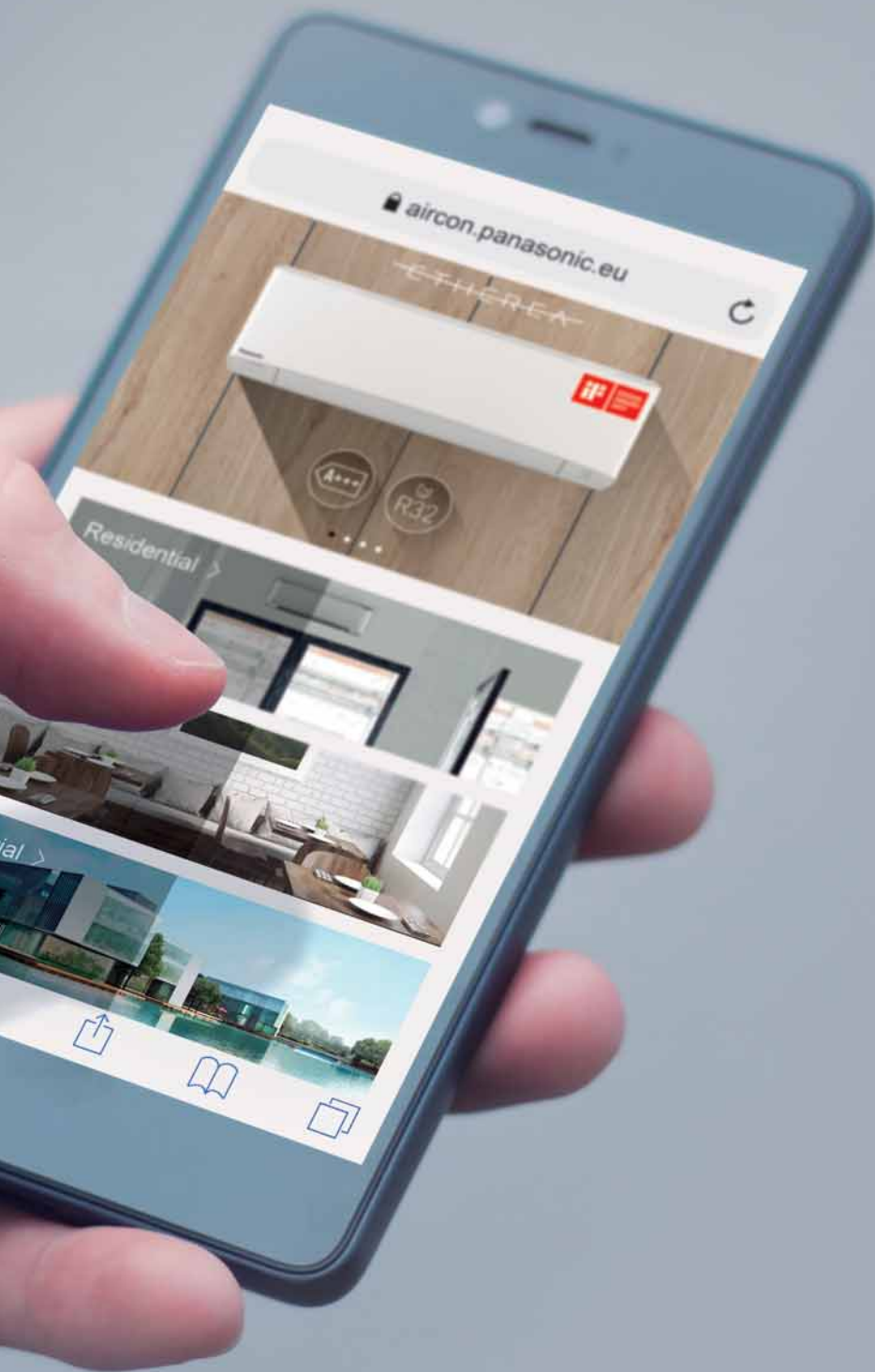

www.aircon.panasonic.se

heating & cooling solutions



Service support for installers
+46 8 566 426 88
aircon_support_se@eu.panasonic.com

Due to the ongoing innovation of our products, the specifications of this catalogue are valid barring typographic errors, and may be subject to minor modifications by the manufacturer without prior warning in order to improve the product. The total or partial reproduction of this catalogue is prohibited without the express authorisation of Panasonic Marketing Europe GmbH.

Panasonic®

To find out how Panasonic cares for you, log on to:
www.aircon.panasonic.se
blogg.panasonicnordic.com/sv
[facebook.com/panasonicsverigevarmpumpar](https://www.facebook.com/panasonicsverigevarmpumpar)

Panasonic Nordic, filial till Panasonic Marketing Europe GmbH, Germany
Telefonvägen 26, 126 26 Hagersten, SWEDEN



Do not add or replace refrigerant other than the specified type. Manufacturer is not responsible for the damage and deterioration in safety due to usage of the other refrigerant.
The outdoor units in this catalogue contains fluorinated greenhouse gases with a GWP higher than 150.

